

**Diagnostik
Diagnostic
Diagnostic
Diagnóstico**





11-0008	Fig. 000 =	6 mmØ	11-0028
11-0009	Fig. 00 =	8 mmØ	11-0029
11-0010	Fig. 0 =	10 mmØ	11-0030
11-0011	Fig. 1 =	12 mmØ	11-0031
11-0012	Fig. 2 =	14 mmØ	11-0032
11-0013	Fig. 3 =	16 mmØ	11-0033
11-0014	Fig. 4 =	18 mmØ	11-0034
11-0015	Fig. 5 =	20 mmØ	11-0035
11-0016	Fig. 6 =	22 mmØ	11-0036
11-0017	Fig. 7 =	24 mmØ	11-0037
11-0018	Fig. 8 =	26 mmØ	11-0038
11-0019	Fig. 9 =	28 mmØ	11-0039
11-0020	Fig. 10 =	30 mmØ	11-0040

11-0025
10,0 cm/4"
Metallgriff für Kehlkopfspiegel
Metal handle for laryngeal mirrors
Manche pour miroirs laryngiens
Mango metálico para espejos laríngeos



Babinsky

11-0045
 22 cm/8¾"

Babinsky

11-0045-01
 Gummi allein
 Rubber only
 Gomme seul
 Goma suelta



Taylor

11-0046
 20 cm/8"



Berliner

11-0047
 20 cm/8"

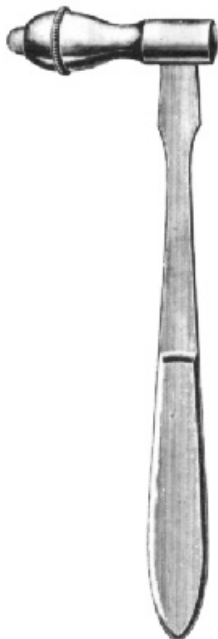

Traube

11-0048
 17 cm/6¾"



Troemner

11-0049
 24 cm/9½"



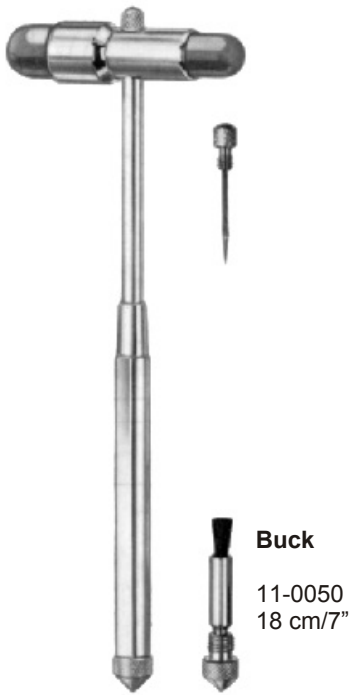

Buck
 11-0050
 18 cm/7"



Déjerine
 11-0051
 20 cm/8"

ohne Nadel
 without needle
 sans aiguille
 sin aguja

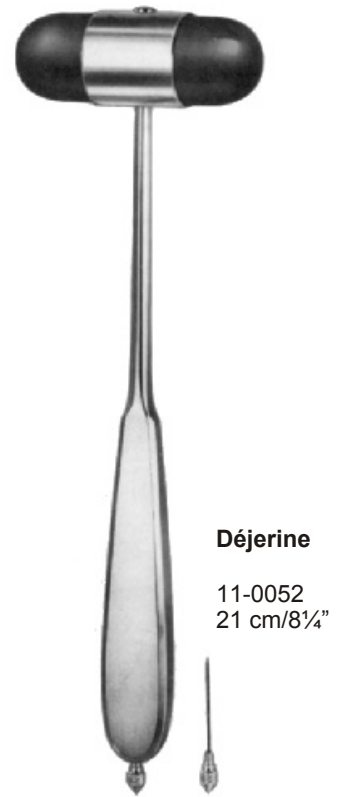

Déjerine
 11-0052
 21 cm/8¼"

mit Nadel
 with needle
 avec aiguille
 con aguja



Rabiner
 11-0053
 23 cm/9"



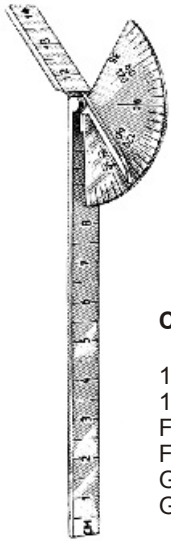

Caroll

11-0056
 14,0 cm/5½"
 Finger-Goniometer
 Finger-Goniometer
 Goniomètre
 Goniómetro



Collin

11-0057
 12,5 cm/5"
 Dynamometer, für Kinder
 Dynamometer, for children
 Dynamomètre, pour enfants
 Dinamómetro, para niños

11-0058
 12,5 cm/5"
 Dynamometer, für Erwachsene
 Dynamometer, for adults
 Dynamomètre, pour adultes
 Dinamómetro, para adultos



Moeltgen

11-0059
 24,0 cm/9½"
 Winkelmesser für die Gliedmaßen
 Goniometer (Flexometer) for extremities
 Goniomètre pour les membres
 Goniómetro para miembros



Wartenberg

11-0060
 19,0 cm/7½"
 Nervrädchen
 Neurological Pinwheel
 Roue neurologique
 Instrumento para examen neurológico



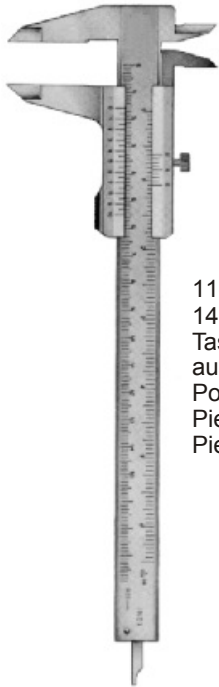

11-0061
14,0 cm/5½"
Taschen-Meßschieber
aus nichtrostendem Stahl
Pocket Slide Caliper, of stainless steel
Pied à coulisse de poche, en acier inoxydable
Pie de rey de bolsillo, de acero inoxidable

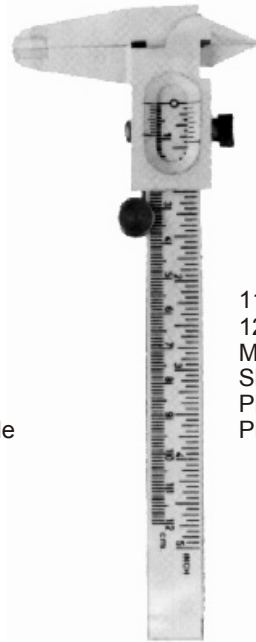

11-0062
12,0 cm/5"
Meßschieber aus Kunststoff
Slide Caliper of synthetic material
Pied à coulisse, en matière synthétique
Pie de rey, en materia sintética



11-0064
1,5 m
Bandmaß in Metallkapsel
aus Wachstuch/Leinen
Tape Measure in metal case
of oil cloth
Metre à ruban dans une boîte de métal
en toile cirée
Cinta métrica en cápsula metálica
de tela encerada

11-0065
2,0 m
aus Stahl
of steel
en acier
de acero



Metall-aMeßstab mit Millimetereinteilung
Metal Rule graduated in millimeters and inches
Règle en métal divisé en centimètres et pouces
Regla métrica de metal graduada en milímetros y pulgadas

11-0066 15,0 cm/6"
11-0067 20,0 cm/8"
11-0068 30,0 cm/12"
11-0069 50,0 cm/20"



11-0070 15,0 cm/6"

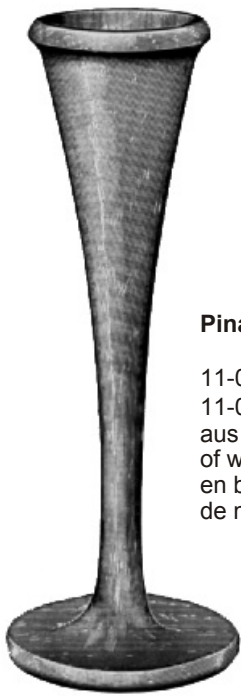

Pinard

11-0071 30,0 cm/12"
11-0072 18,0 cm/7"
aus Holz
of wood
en bois
de madera



Pinard

11-0073 15,0 cm/6"
aus Aluminium
of aluminium
en aluminium
de aluminio

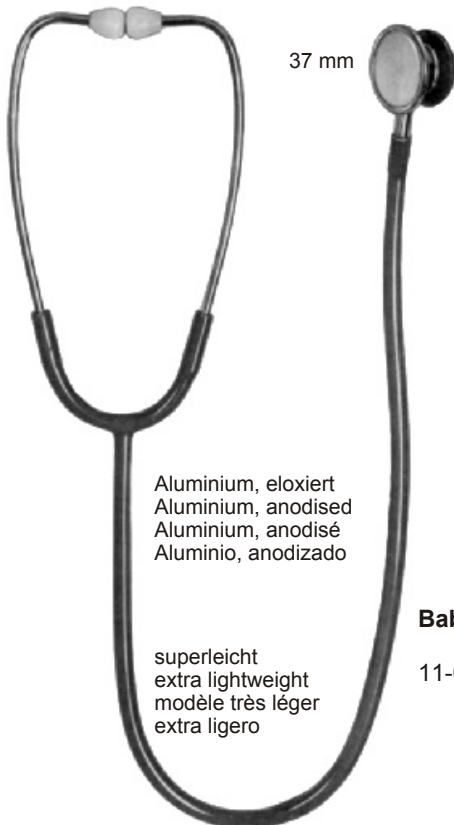

37 mm

Aluminium, eloxiert
Aluminium, anodised
Aluminium, anodisé
Aluminio, anodizado

superleicht
extra lightweight
modèle très léger
extra ligero

Baby-Duplex

11-0075

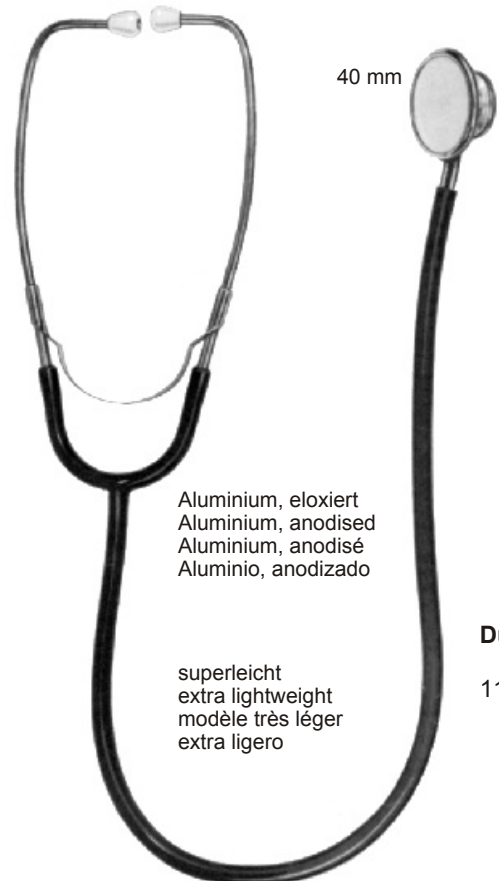

40 mm

Aluminium, eloxiert
Aluminium, anodised
Aluminium, anodisé
Aluminio, anodizado

superleicht
extra lightweight
modèle très léger
extra ligero

Duplex

11-0076





47 mm

Anestophon
11-0077



Rirap

11-0078

Drei verschiedene austauschbare Trichteransätze
Three additional interchangeable bell-type pieces
Trois pièces supplémentaires interchangeables
Tres diferentes piezas adicionales intercambiables
en forma de embudo



aus rostfreiem Stahl
stainless steel
en acier inoxydable
de acero inoxidable

Cardiophon
11-0079



Diplomat Presameter

11-0080
Quecksilbergerät
Mercury apparatus
Appareil de mercure
Tensiómetro de mercurio

mit Hakenmanschette
with hook cuff
avec manchette à crochets
con brazaletes a ganchos

11-0081
mit Velcromanschette
with velcro cuff
avec manchette velcro
con brazaletes velcro



Empire

11-0082
Quecksilbergerät
Mercury apparatus
Appareil de mercure
Tensiómetro de mercurio

mit Hakenmanschette
with hook cuff
avec manchette à crochets
con brazaletes a ganchos

11-0083
mit Velcromanschette
with velcro cuff
avec manchette velcro
con brazaletes velcro





Precisa

11-0084
Einhandmodell
One hand model
Modèle à main
Modelo a mano

mit Velcromanschette
with velcro cuff
avec manchette velcro
con brazaletes velcro



Minimus III

11-0085
Einhandmodell
One hand model
Modèle à main
Modelo a mano

mit Hakenmanschette
with hook cuff
avec manchette à crochets
con brazaletes a ganchos

11-0086
mit Velcromanschette
with velcro cuff
avec manchette velcro
con brazaletes velcro



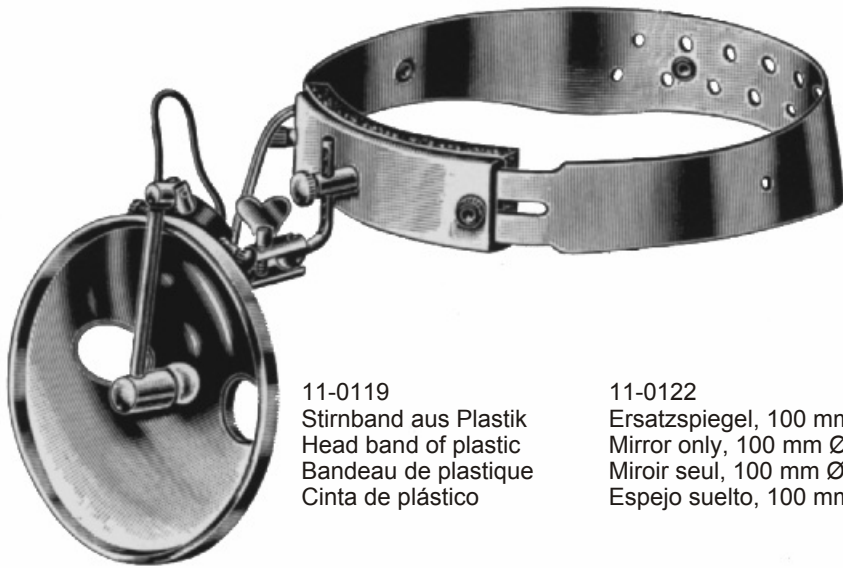

11-0119
Stirnband aus Plastik
Head band of plastic
Bandeau de plastique
Cinta de plástico

11-0122
Ersatzspiegel, 100 mm Ø
Mirror only, 100 mm Ø
Miroir seul, 100 mm Ø
Espejo suelto, 100 mm Ø

Clar
Stirnlampe
Head Lamp
Eclaireur frontal
Lámpara frontal

11-0118
mit Stirnband aus Plastik, 100 mm Ø
with head band of plastic, 100 mm Ø
avec bandeau de plastique, 100 mm de Ø
con cinta de plástico, 100 mm de Ø

11-0120
mit Stirnband aus Celluloid, 100 mm Ø
with head band of celluloid, 100 mm Ø
avec bandeau de celluloid, 100 mm de Ø
con cinta de celuloide, 100 mm de Ø

11-0121
Stirnband aus Celluloid
Head band of celluloid
Bandeau de celluloid
Cinta de celuloide

11-0123
Ersatz-Birnchen, 6 V
Spare bulb, 6 V
Lampe de rechange, 6 V
Bombillas de repuesto, 6 V

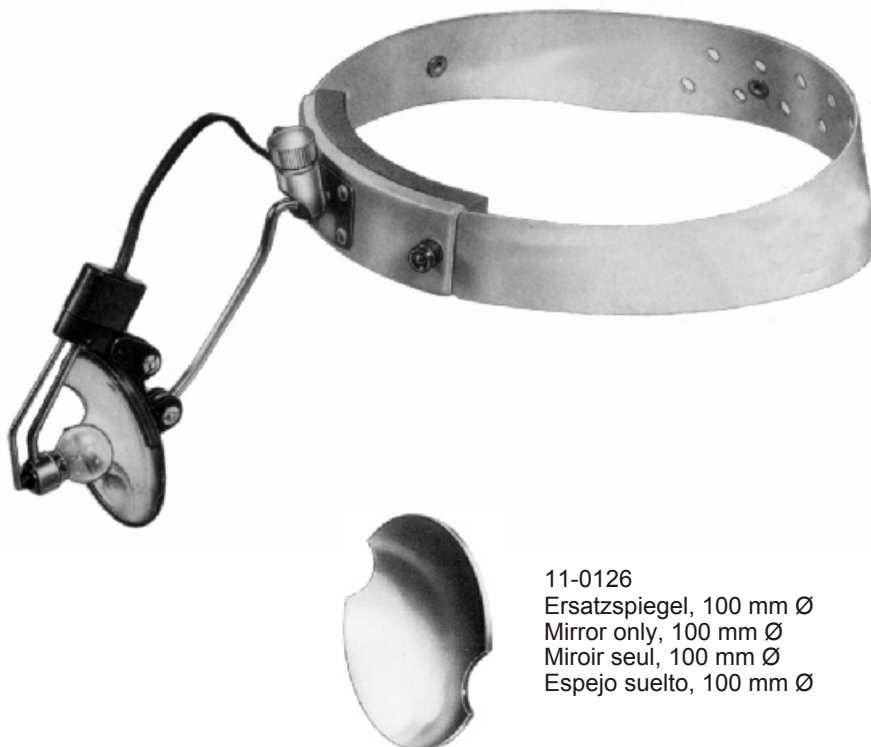

Clar
Stirnlampe
Head Lamp
Eclaireur frontal
Lámpara frontal

11-0124
mit Stirnband aus Celluloid
with head band of celluloid
avec bandeau de celluloid
con cinta de celuloide

11-0125
Stirnband aus Celluloid
Head band of celluloid
Bandeau de celluloid
Cinta de celuloide

11-0126
Ersatzspiegel, 100 mm Ø
Mirror only, 100 mm Ø
Miroir seul, 100 mm Ø
Espejo suelto, 100 mm Ø

 11-0127
Ersatz-Birnchen, 6 V
Spare bulb, 6 V
Lampe de rechange, 6 V
Bombillas de repuesto, 6 V





Schioetz
 Tonometer, Spez. 5
 Tonometer, Spec. 5
 Tonomètre, Spécif. 5
 Tonómetro, Spec. 5

11-0130
 gerade Skala
 straight scale
 cadre droit
 escala recta

11-0131
 schräge Skala
 inclined scale
 cadre courbe
 escala inclinada

11-0132
 Eichgebühr
 rate for gauging
 droits pour étalonnage
 precio para aforo



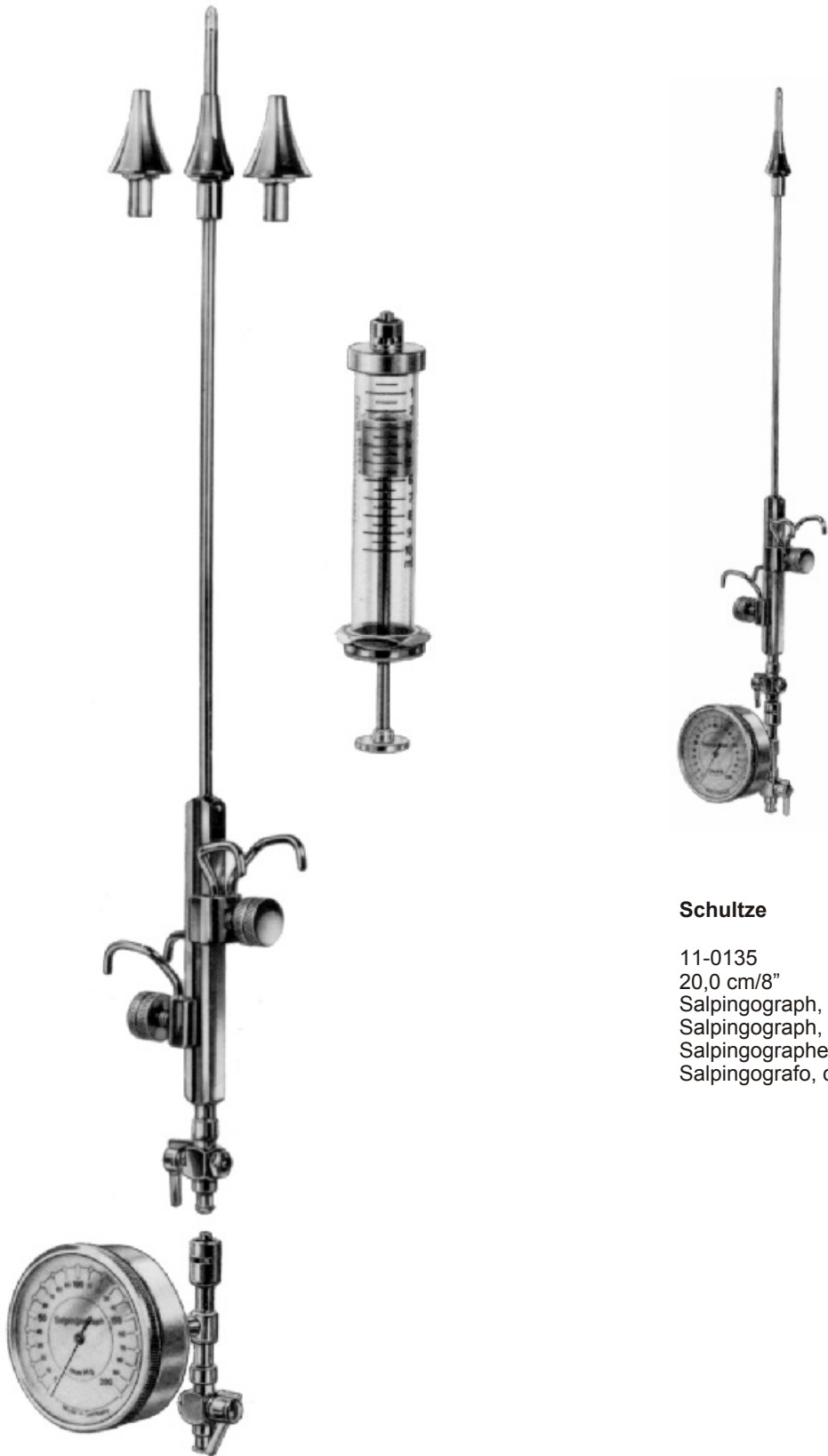

Schultze

11-0135
20,0 cm/8"
Salpingograph, komplett
Salpingograph, complete
Salpingographe, complet
Salpingografo, completo





11-0136
Komprimeter
Comprimeter
Appareil compressif complet
Aparato de compresión

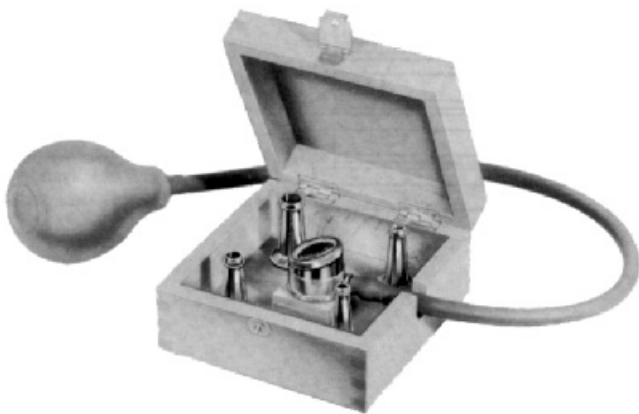

Fig. 1
11-0151
6 mm Ø



Fig. 2
11-0152
7,5 mm Ø



Fig. 3
11-0153
8,2 mm Ø



Fig. 4
11-0154
10 mm Ø

Bruenings

11-0150
Ohrspekula, komplett
Ear Specula, complete
Spéculum auriculaire, complet
Espéculo auricular, completo

11-0156
Gummiball mit Schlauch, allein
Rubber Bulb and tube, only
Poire soufflante et tube, seule
Insuflador con tubo, solo

11-0157
Holzetui, allein
Wooden Case, only
Boîte en bois, seule
Estuche de madera, solo

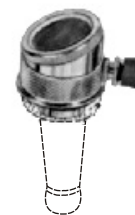

11-0155
Kopfstück, allein
Head piece, only
Pièce de tête, seule
Pieza de cabeza, solo



Hartmann

Ohrspekula
Ear Specula
Spéculum auriculaire
Espéculo auricular



Fig. 0
11-0160
3,0 mm Ø



Fig. 1
11-0161
4,0 mm Ø



Fig. 2
11-0162
5,0 mm Ø



Fig. 3
11-0163
6,0 mm Ø



Fig. 4
11-0164
7,5 mm Ø



Hartmann
 c 128
 11-0180-00



Hartmann
 c¹ 256
 11-0180-01



Hartmann
 c² 512
 11-0180-02



Hartmann
 c³ 1024
 11-0180-03



Hartmann
 c⁴ 2048
 11-0180-04



Hartmann
 c⁵ 4096
 11-0180-05

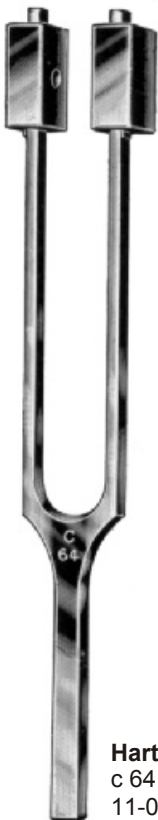

Hartmann
 c 64
 11-0180-06



Hartmann
 c 128
 11-0180-07



Hartmann
 c¹ 256
 11-0180-08



Hartmann
 mit Fuß, with foot
 avec pied, con pie
 c¹ 256
 11-0180-09



Lucae
 c 128
 11-0181-00

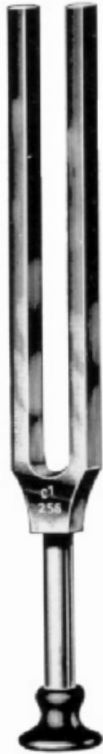

Lucae
 c¹ 256
 11-0181-01



Lucae
 c² 512
 11-0181-02



Lucae
 c³ 1024
 11-0181-03



Lucae
 c⁴ 2048
 11-0181-04



Lucae
 c⁵ 4096
 11-0181-05



Lucae
 c 128
 11-0181-06





French
c₂ 16
Doppel-Contra
Double-contra
Double-contra
Doble-contra

11-0182-01



French
c₁ 32
Contra
Contra
Contra
Contra

11-0182-02



Rydel-Seiffer
C 64 / c 128
mit Dämpfern = C 64 / ohne Dämpfer = c 128
with clamps = C 64 / without clamps = c 128
avec curseurs = C 64 / sans curseurs = c 128
con sordinas = C 64 / sin sordinas = c 128

11-0183-01



Stimmgabel für neurologische Untersuchungen, mit Reflexhammer, Nadelrad, Pinsel und Nadel

Tuning fork for neurological examinations, with percussion hammer, pinwheel, brush, and needle

Diapason pour examens neurologiques, avec marteaux-percuteurs, roue aux épingles, brosse et aiguille

Diapasón para exámenes neurológicos, con martillo percusor, rueda con espinas, cepillo y aguja

11-0184-01



Koenig
A 109
verschiebbar bis g
variable up to g
variable jusqu' à g
variable hasta g

11-0185-01



a¹ 440
11-0186-01



A 218
11-0186-02



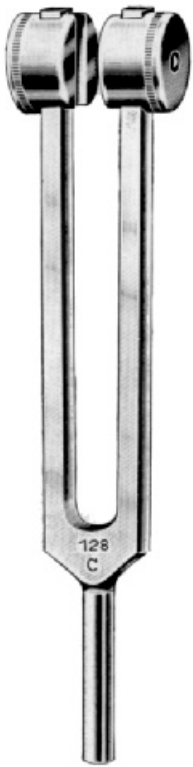

c 128
11-0187-00



c¹ 256
11-0187-01

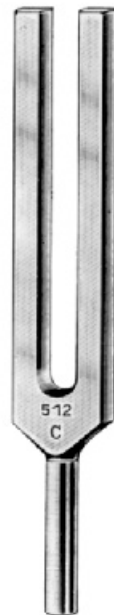

c² 512
11-0187-02



c³ 1024
11-0187-03



c⁴ 2048
11-0187-04

Stimmgabeln aus Spezial Aluminium-Magnesium-Legierung für medizinische Zwecke z. B. für Gehörprüfungen (Luft- und Knochenleitung), für Sensibilitätsprüfungen und andere diagnostische Zwecke.

Tuning forks made from special aluminium-magnesium-alloy, for medical purposes, such as examination of hearing (air and bone conduction), for sensibility examinations, and other diagnostic purposes.

Diapasons faits d' un alliage spécial d' aluminium et de magnésium, à des fins médicales, telles que l' examen de l' ouïe (conduite de l' air et os) et l' examen de la sensibilité et tout autre diagnostique.

Diapasón de una aleación especial al aluminio y magnesio, destinado a fines médicos por ejemplo, reconocimiento del oído (conducto del aire y huesos), reconocimiento de la sensibilidad y otros fines diagnósticos.



11-0188-00
 Satz zu 5 Spezial Aluminium-Magnesium-
 Legierung Stimmgabeln im Etui
 Set of 5 special aluminium-magnesium-
 alloy tuning forks in a case
 Jeu de 5 diapasons, alliage spécial
 alluminium/magnésium dans un étui
 Juego de 5 diapasones de una aleación
 especial de aluminio y magnesio en estuche
 (11-0187-00, 11-0187-01, 11-0187-02,
 11-0187-03, 11-0187-04)



11-0189-05
 Satz zu 5 Hartmann Stimmgabeln im Etui
 Set of 5 Hartmann tuning forks in a case
 Jeu de 5 Hartmann diapasons dans un étui
 Juego de 5 Hartmann diapasones en estuche
 (11-0180-02, 11-0180-03, 11-0180-04,
 11-0180-07, 11-0180-08)



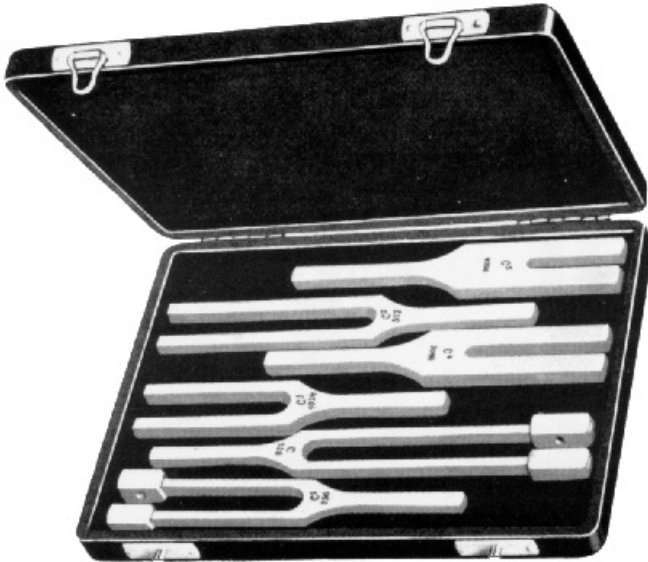

11-0189-06
Satz zu 6 Hartmann Stimmgabeln im Etui
Set of 6 Hartmann tuning forks in a case
Jeu de 6 Hartmann diapasons dans un étui
Juego de 6 Hartmann diapasones en estuche
(11-0180-02, 11-0180-03, 11-0180-04,
11-0180-05, 11-0180-07, 11-0180-08)



11-0189-08
Satz zu 8 Hartmann Stimmgabeln im Etui
Set of 8 Hartmann tuning forks in a case
Jeu de 8 Hartmann diapasons dans un étui
Juego de 8 Hartmann diapasones en estuche
(11-0180-02, 11-0180-03, 11-0180-04, 11-0180-05,
11-0180-06, 11-0180-07, 11-0180-08, 11-0182-02)

Pinzetten
Forceps
Pinces
Pinzas





12-0101



12-0102



12-0103



12-0104



12-0105

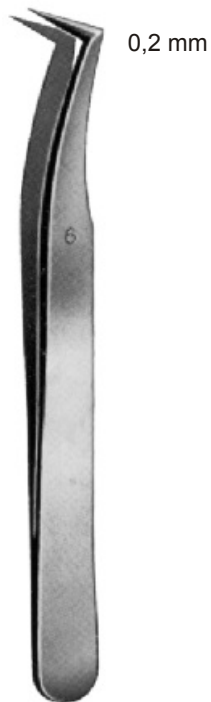

12-0106



12-0107

1
2



Standard

- 12-0199 10,5 cm/4¼"
- 12-0200 11,5 cm/4½"
- 12-0201 13,0 cm/5"
- 12-0202 14,5 cm/5½"
- 12-0203 16,0 cm/6¼"
- 12-0204 18,0 cm/7"
- 12-0205 20,0 cm/8"
- 12-0206 25,0 cm/10"
- 12-0207 30,0 cm/12"

12-0205L 20,0 cm/8"
Isoliert für Laser- und Elektrochirurgie
insulated for Laser- and Electrosurgery
isolé pour les interventions au laser et
électrochirurgical
aislado para láser y electrocirugía



Standard

- gebogen, curved
courbe, curvas
- 12-0209 10,5 cm/4¼"
 - 12-0210 11,5 cm/4½"
 - 12-0211 13,0 cm/5"
 - 12-0212 14,5 cm/5½"
 - 12-0213 16,0 cm/6¼"
 - 12-0214 18,0 cm/7"
 - 12-0215 20,0 cm/8"
 - 12-0216 25,0 cm/10"
 - 12-0217 30,0 cm/12"



schmal, narrow
étroite, estrechas

- 12-0220 11,5 cm/4½"
- 12-0221 13,0 cm/5"
- 12-0222 14,5 cm/5½"
- 12-0223 16,0 cm/6¼"
- 12-0224 18,0 cm/7"
- 12-0225 20,0 cm/8"
- 12-0226 25,0 cm/10"
- 12-0227 30,0 cm/12"



schmal, narrow
étroite, estrechas

- 12-0230 11,5 cm/4½"
- 12-0231 13,0 cm/5"
- 12-0232 14,5 cm/5½"
- 12-0233 16,0 cm/6¼"
- 12-0234 18,0 cm/7"
- 12-0235 20,0 cm/8"
- 12-0236 25,0 cm/10"
- 12-0237 30,0 cm/12"



fein, delicate
fine, finas

- 12-0241 13,0 cm/5"
- 12-0242 14,5 cm/5½"



Schwedisches Modell
Swedish pattern
Modèle suédois
Modelo sueco

- 12-0247 13,0 cm/5"
- 12-0248 15,0 cm/6"
- 12-0249 17,0 cm/6¾"



USA-Mod. Standard

12-0250	12,0 cm/4 ³ / ₄ "
12-0251	13,0 cm/5"
12-0252	14,5 cm/5 ¹ / ₂ "
12-0253	15,5 cm/6"
12-0254	18,0 cm/7"
12-0255	21,0 cm/8 ¹ / ₄ "
12-0256	25,0 cm/10"
12-0257	31,0 cm/12 ¹ / ₄ "



USA-Mod.
 schmal, narrow
 étroite, estrechas

12-0260	12,0 cm/4 ³ / ₄ "
12-0261	13,0 cm/5"
12-0262	14,5 cm/5 ¹ / ₂ "
12-0263	15,5 cm/6"



engl. Mod.

12-0265	13,0 cm/5"
12-0266	14,5 cm/5 ¹ / ₂ "
12-0267	15,5 cm/6"

12



Semken

12-0271	12,5 cm/5"
12-0272	15,0 cm/6"



Adson

Micro 0,8 mm	
12-0274	12,0 cm/4 ³ / ₄ "
1,2 mm	
12-0275	12,0 cm/4 ³ / ₄ "



Mc Indoe

12-0277	15,0 cm/6"
---------	------------



Potts-Smith

- 12-0280 18,0 cm/7"
- 12-0281 21,0 cm/8 1/4"
- 12-0282 25,0 cm/10"



Potts-Smith

- gebogen, curved
courbe, curvas
- 12-0283 18,0 cm/7"
 - 12-0284 21,0 cm/8 1/4"
 - 12-0285 25,0 cm/10"



Gerald

- 12-0288 18,0 cm/7"



Gerald

- gebogen, curved
courbe, curvas
- 12-0289 18,0 cm/7"



Taylor

- 12-0290 17,5 cm/7"



Taylor

- gebogen, curved
courbe, curvas
- 12-0291 17,5 cm/7"



Taylor

- 12-0292 17,5 cm/7"



Taylor

- gebogen, curved
courbe, curvas
- 12-0293 17,5 cm/7"





Waugh

12-0294 15,0 cm/6"
12-0295 20,0 cm/8"



Brophy

12-0296 20,0 cm/8"



Brophy

gebogen, curved
courbe, curvas
12-0297 20,0 cm/8"

12



Cushing

12-0298 17,5 cm/7"



Cushing

gebogen, curved,
courbe, curvas
12-0299 17,5 cm/7"



1:2

12-0308	10,5 cm/4 ¹ / ₄ "
12-0300	11,5 cm/4 ¹ / ₂ "
12-0301	13,0 cm/5"
12-0302	14,5 cm/5 ¹ / ₂ "
12-0303	16,0 cm/6 ¹ / ₄ "
12-0304	18,0 cm/7"
12-0305	20,0 cm/8"
12-0306	25,0 cm/10"
12-0307	30,0 cm/12"



2:3

12-0310	11,5 cm/4 ¹ / ₂ "
12-0311	13,0 cm/5"
12-0312	14,5 cm/5 ¹ / ₂ "
12-0313	16,0 cm/6 ¹ / ₄ "
12-0314	18,0 cm/7"
12-0315	20,0 cm/8"
12-0316	25,0 cm/10"
12-0317	30,0 cm/12"



3:4

12-0321	13,0 cm/5"
12-0322	14,5 cm/5 ¹ / ₂ "
12-0323	16,0 cm/6 ¹ / ₄ "



4:5

12-0327	13,0 cm/5"
12-0328	14,5 cm/5 ¹ / ₂ "
12-0329	16,0 cm/6 ¹ / ₄ "



1:2

schmal, narrow
étroite, estrechas

12-0331	13,0 cm/5"
12-0332	14,5 cm/5 ¹ / ₂ "
12-0333	16,0 cm/6 ¹ / ₄ "
12-0335	20,0 cm/8"



USA-Mod. 1:2

12-0340	12,0 cm/4 ³ / ₄ "
12-0341	13,0 cm/5"
12-0342	14,5 cm/5 ¹ / ₂ "
12-0343	15,5 cm/6"
12-0344	18,0 cm/7"
12-0345	21,0 cm/8 ¹ / ₄ "
12-0346	25,0 cm/10"
12-0347	31,0 cm/12 ¹ / ₄ "



USA-Mod. 2:3

12-0350	12,0 cm/4 ³ / ₄ "
12-0351	13,0 cm/5"
12-0352	14,5 cm/5 ¹ / ₂ "
12-0353	15,5 cm/6"
12-0354	18,0 cm/7"
12-0355	21,0 cm/8 ¹ / ₄ "
12-0356	25,0 cm/10"
12-0357	31,0 cm/12 ¹ / ₄ "



USA-Mod.
fein, delicate
fine, finas

12-0371 13,0 cm/5"
12-0372 14,5 cm/5½"
12-0373 15,0 cm/6"



Adlerkreutz



2:3



4:5

15 cm/6"	12-0374-15	12-0375-15
20 cm/8"	12-0374-20	12-0375-20
25 cm/10"	12-0374-25	12-0375-25

1
2



Semken

12-0381 12,5 cm/5"
12-0382 15,0 cm/6"



Adson

Micro 0,8 mm
12-0384 12,0 cm/4½"
12-0384-15 15,0 cm/6"

1,2 mm
12-0385 12,0 cm/4½"
12-0385-15 15,0 cm/6"



Adson Brown
 9 x 9
 12-0386 12,0 cm/4½"



Gillies
 12-0387 15,0 cm/6"



Gerald
 12-0388 17,5 cm/7"



Gerald
 gebogen, curved
 courbe, curvas
 12-0389 17,5 cm/7"



Taylor

12-0390 17,5 cm/7"



Taylor

gebogen, curved,
courbe, curvas
12-0391 17,5 cm/7"



Cushing

12-0392 17,5 cm/7"



Cushing

gebogen, curved,
courbe, curvas
12-0393 17,5 cm/7"

12



Brophy

12-0394 20,0 cm/8"



Brophy

gebogen, curved,
courbe, curvas
12-0395 20,0 cm/8"



Waugh

12-0396 15,0 cm/6"
12-0397 20,0 cm/8"



Taylor

12-0398 17,5 cm



Taylor

12-0399 17,5 cm/7"



Potts-Smith

12-0400 18,0 cm/7"
12-0401 21,0 cm/8¼"
12-0402 25,0 cm/10"



Potts-Smith

gebogen, curved,
courbe, curvas

12-0403 18,0 cm/7"
12-0404 21,0 cm/8¼"
12-0405 25,0 cm/10"



Lane 1:2

12-0407 14,5 cm/5½"
12-0408 18,0 cm/7"



Lane 2:3

12-0409 14,5 cm/5½"
12-0410 18,0 cm/7"



Bonney 1:2

12-0411 18,0 cm/7"



Bonney 2:3

12-0412 18,0 cm/7"



Mod. Russ.

- 12-0413 15,0 cm/6"
- 12-0414 20,0 cm/8"
- 12-0415 25,0 cm/10"



Singley-Tuttle

- 12-0416 23,0 cm/9"



Nelson

- 12-0417 23,0 cm/9"



Mod. Mayo-Russ.

- 12-0419 23,0 cm/9"

1
2



De Bakey
 gerade, straight,
 droite, rectas

	1,5 mm	2,0 mm	2,7 mm	3,5 mm
16,0 cm/6¼"	12-0420-16	12-0421-16	12-0422-16	12-0423-16
20,0 cm/8"	12-0420-20	12-0421-20	12-0422-20	12-0423-20
24,0 cm/9½"	12-0420-24	12-0421-24	12-0422-24	12-0423-24
30,0 cm/12"	12-0420-30	12-0421-30	12-0422-30	12-0423-30



De Bakey
 abgewinkelt, angular,
 angulaire, angulares

	2,0 mm
16,0 cm/6¼"	12-0424-16
20,0 cm/8"	12-0424-20
24,0 cm/9½"	12-0424-24
30,0 cm/12"	12-0424-30



12-0425 10,5 cm/4½"

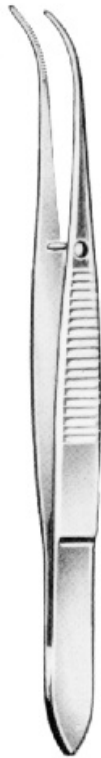

12-0426 10,5 cm/4½"



12-0427 10,5 cm/4½"

1
2



12-0428 10,5 cm/4½"



12-0429 10,5 cm/4½"



12-0430 10,5 cm/4½"



glatt, smooth
 lisse, lisas
 ohne Stift, without pin
 sans cheville, sin perno

12-0431	8,0 cm/3¼"
12-0432	9,0 cm/3½"
12-0433	10,5 cm/4¼"
12-0434	11,5 cm/4½"
12-0435	12,5 cm/5"
12-0436	8,0 cm/3¼"
12-0437	9,0 cm/3½"
12-0438	10,5 cm/4¼"
12-0439	11,5 cm/4½"
12-0440	12,5 cm/5"



gerieft, serrated
 striée, estriadas
 ohne Stift, without pin
 sans cheville, sin perno

12-0441	8,0 cm/3¼"
12-0442	9,0 cm/3½"
12-0443	10,5 cm/4¼"
12-0444	11,5 cm/4½"
12-0445	12,5 cm/5"
12-0446	8,0 cm/3¼"
12-0447	9,0 cm/3½"
12-0448	10,5 cm/4¼"
12-0449	11,5 cm/4½"
12-0450	12,5 cm/5"



12



glatt, smooth
 lisse, lisas
 mit Stift, with pin
 avec cheville, con perno

12-0451	8,0 cm/3¼"
12-0452	9,0 cm/3½"
12-0453	10,5 cm/4¼"
12-0454	11,5 cm/4½"
12-0455	12,5 cm/5"
12-0456	8,0 cm/3¼"
12-0457	9,0 cm/3½"
12-0458	10,5 cm/4¼"
12-0459	11,5 cm/4½"
12-0460	12,5 cm/5"



gerieft, serrated
 striée, estriadas
 mit Stift, with pin
 avec cheville, con perno

12-0461	8,0 cm/3¼"
12-0462	9,0 cm/3½"
12-0463	10,5 cm/4¼"
12-0464	11,5 cm/4½"
12-0465	12,5 cm/5"
12-0466	8,0 cm/3¼"
12-0467	9,0 cm/3½"
12-0468	10,5 cm/4¼"
12-0469	11,5 cm/4½"
12-0470	12,5 cm/5"





Feilchenfeld

- 12-0471 7,5 cm/3"
- 12-0472 9,0 cm/3½"
- 12-0473 11,5 cm/4½"



Hunter

- 12-0474 10,5 cm/4¼"



Hunter

- 12-0475 10,5 cm/4¼"

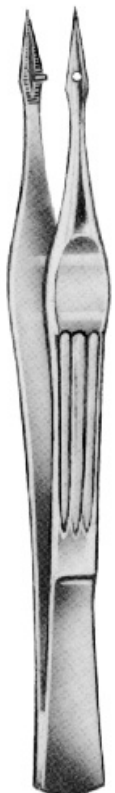

Walter-Carmalt

- 12-0476 10,5 cm/4¼"



Walter-Carmalt

- 12-0477 10,5 cm/4¼"

Mikroskopierpinzetten
Microscope Forceps
Pinces pour microscopier
Pinzas para el microscopio



- 12-0485
10,0 cm/4"
stumpf
blunt
mousse
romas



- 12-0486
10,0 cm/4"
spitz
sharp
pointue
agudas





Yasargil
 22,0 cm/8³/₄"
 glatt, smooth,
 lisse, lisas



Ø 3 mm
 12-0487-03



Ø 5 mm
 12-0487-05



Yasargil
 22,0 cm/8³/₄"
 gerieft, serrated,
 striée, estriadas



Ø 3 mm
 12-0488-03



Ø 5 mm
 12-0488-05



Heifetz
 22,0 cm/8³/₄"
 gerieft, serrated,
 striée, estriadas



Ø 3 mm
 12-0489-03



Ø 5 mm
 12-0489-05

1
2



Beer

12-0491 8,0 cm/3¼"
 120492 9,0 cm/3½"



Littauer

12-0493 8,5 cm/3½"



Douglas

schmal, narrow,
 étroite, estrechas
 12-0494-01 9,0 cm/3½"



Douglas

breit, broad,
 large, anchas
 12-0494-02 9,0 cm/3½"



Kuehne

12-0495-01
10,5 cm/4¼"
gerade
straight
droite
rectas

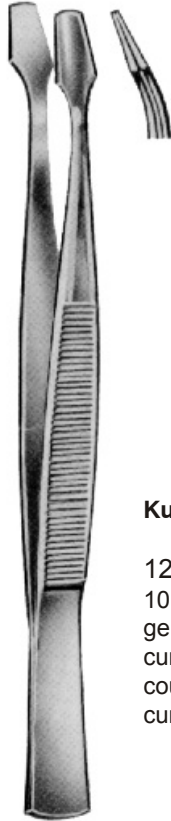

Kuehne

12-0495-02
10,5 cm/4¼"
gebogen
curved
courbe
curvas



Kuehne

12-0495-03
10,5 cm/4¼"
überkreuzt
curved crossed
courbe croisée
curvas cruzadas



12-0496
10,5 cm/4¼"

1
2

Splitterzangen
Splinter Forceps
Pinces à échardes
Pinzas para espinas

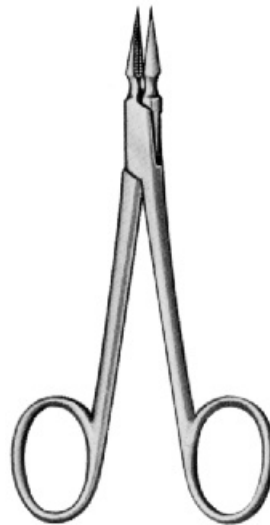

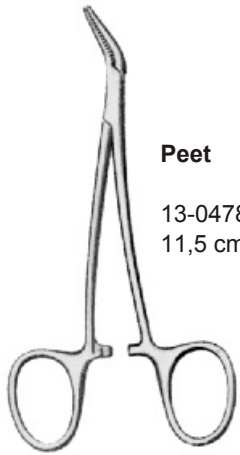

Peet

13-0478
 11,5 cm/4½"

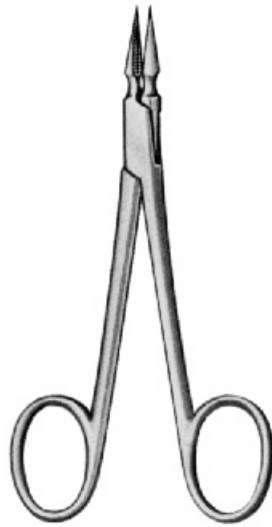

Arthur

13-0479
 13,5 cm/5½"
 gerade, straight,
 droite, recta

13-0480
 gebogen, curved,
 courbe, curva



Stieglitz

13-0481
 13,5 cm/5½"
 gerade, straight,
 droite, recta

13-0482
 gebogen, curved,
 courbe, curva



Ralk
 15,0 cm/6"



13-0483
 gerade
 straight
 droite
 recta

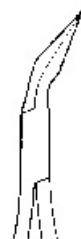

13-0484
 gebogen
 curved
 courbe
 curva

13

Verschiedene Klemmen
Miscellaneous Forceps
Pinces diverses
Pinzas diversas





14-0497



14-0498

Dieffenbach
6,0 cm/2½"



3,5 cm/1½"
14-0499 13-0501



Dieffenbach

5,0 cm/2"
14-0500 13-0502



John Hopkins

14-0505 5,0 cm/2"
14-0506 6,5 cm/2½"
14-0507 7,5 cm/3"

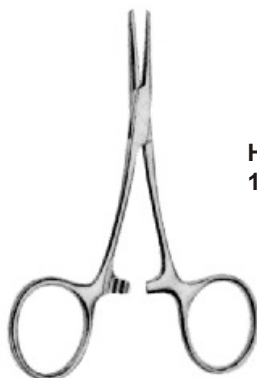

14-0503 micro
14-0508

Hartmann
10,0 cm/4"

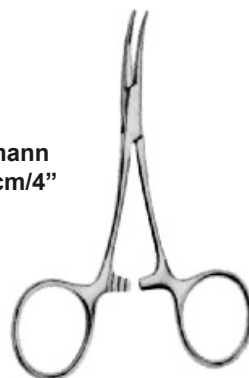

14-0504 micro
14-0509



Halsted-Mosquito

14-0510	12,5 cm/5"	14-0515
14-0511	14,0 cm/5½"	14-0516
14-0514 micro	12,5 cm/5"	14-0519 micro
gerade		gebogen
straight		curved
droite		courbe
recta		curva



Halsted-Mosquito 1:2

14-0520	12,5 cm/5"	14-0525
14-0521	14,0 cm/5½"	14-0526
14-0529 micro	12,5 cm/5"	14-0530 micro
gerade		gebogen
straight		curved
droite		courbe
recta		curva

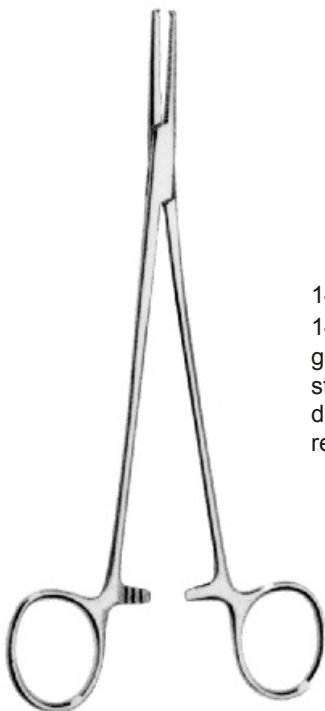

14-0512	18,0 cm/7"
14-0513	21,0 cm/8¼"
gerade	
straight	
droite	
recta	

Halsted-Mosquito

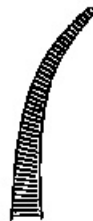

14-0517
14-0518
gebogen
curved
courbe
curva



14-0522	18,0 cm/7"
14-0523	21,0 cm/8¼"
gerade	
straight	
droite	
recta	

Halsted-Mosquito 1:2



14-0527
14-0528
gebogen
curved
courbe
curva





Pean
 14-0531 14,0 cm/5½"
 14-0532 16,0 cm/6¼"



Pean
 14,0 cm/5½"
 fein, delicate, fine, fina

 14-0538
 gerade, straight,
 droite, recta

 14-0540
 gebogen, curved,
 courbe, curva

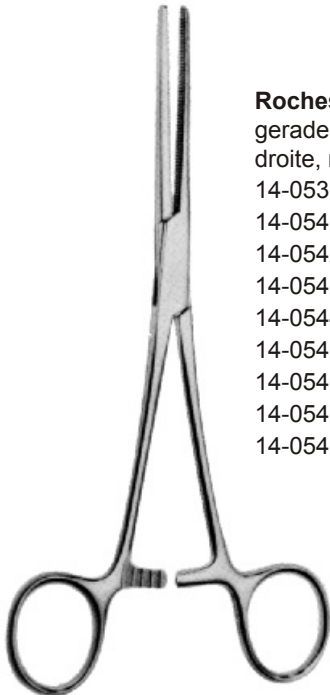

Rochester-Pean
 gerade, straight,
 droite, recta
 14-0533 13,0 cm/5"
 14-0541 14,0 cm/5½"
 14-0542 16,0 cm/6¼"
 14-0543 18,0 cm/7"
 14-0544 20,0 cm/8"
 14-0545 22,0 cm/8¾"
 14-0546 24,0 cm/9½"
 14-0547 26,0 cm/10¼"
 14-0549 30,0 cm/12"

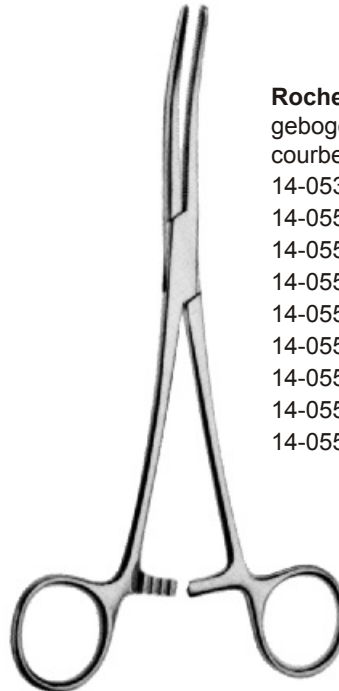

Rochester-Pean
 gebogen, curved,
 courbe, curva
 14-0535 13,0 cm/5"
 14-0551 14,0 cm/5½"
 14-0552 16,0 cm/6¼"
 14-0553 18,0 cm/7"
 14-0554 20,0 cm/8"
 14-0555 22,0 cm/8¾"
 14-0556 24,0 cm/9½"
 14-0557 26,0 cm/10¼"
 14-0559 30,0 cm/12"



Kocher
 14,0 cm/5½"
 fein, delicate, fine, fina

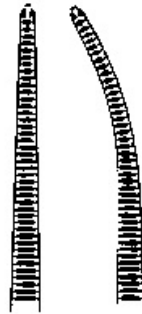

14-0566	14-0568
gerade	gebogen
straight	curved
droite	courbe
recta	curva

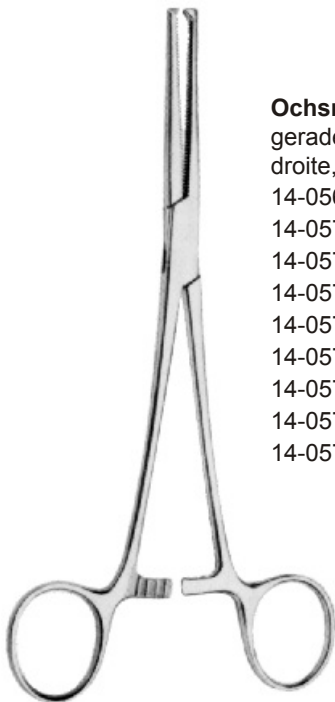

Ochsner-Kocher
 gerade, straight,
 droite, recta

14-0561	13,0 cm/5"
14-0571	14,0 cm/5½"
14-0572	16,0 cm/6¼"
14-0573	18,0 cm/7"
14-0574	20,0 cm/8"
14-0575	22,0 cm/8¾"
14-0576	24,0 cm/9½"
14-0577	26,0 cm/10¼"
14-0579	30,0 cm/12"

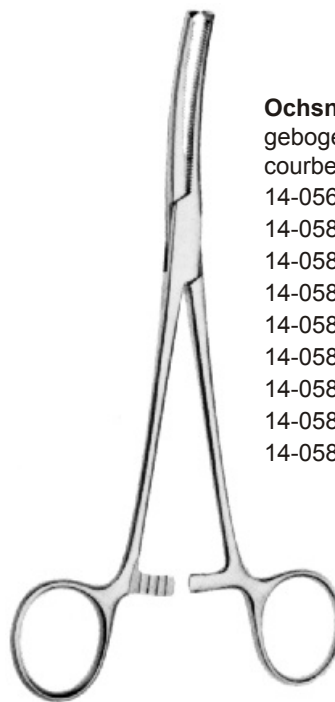

Ochsner-Kocher
 gebogen, curved,
 courbe, curva

14-0563	13,0 cm/5"
14-0581	14,0 cm/5½"
14-0582	16,0 cm/6¼"
14-0583	18,0 cm/7"
14-0584	20,0 cm/8"
14-0585	22,0 cm/8¾"
14-0586	24,0 cm/9½"
14-0587	26,0 cm/10¼"
14-0589	30,0 cm/12"





Rochester-Carmalt



14-0591
 14-0593
 gerade
 straight
 droite
 recta



16,0 cm/6¼"
 20,0 cm/8"
 14-0595
 14-0597
 gebogen
 curved
 courbe
 curva

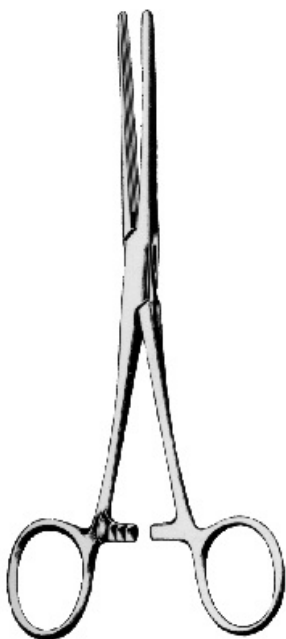

Bainbridge
 15 cm/6"



14-0596
 gerade
 straight
 droite
 recta



14-0598
 gebogen
 curved
 courbe
 curva



Bainbridge
 18,5 cm/7¼"



14-0599
 gerade
 straight
 droite
 recta



14-0600
 gebogen
 curved
 courbe
 curva

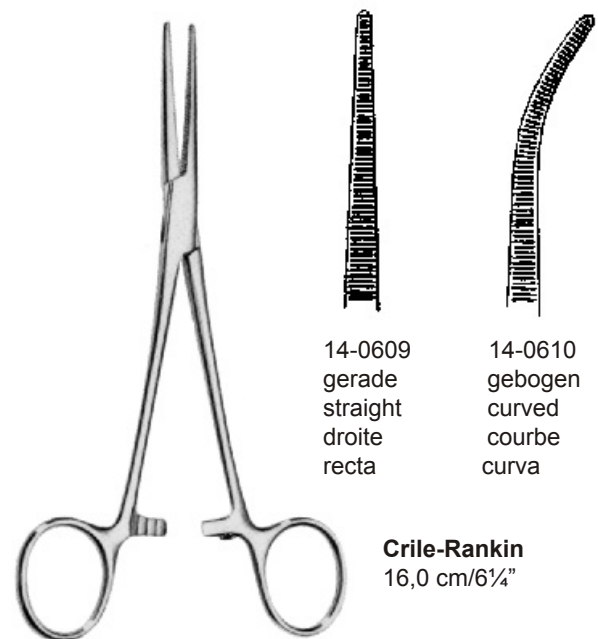
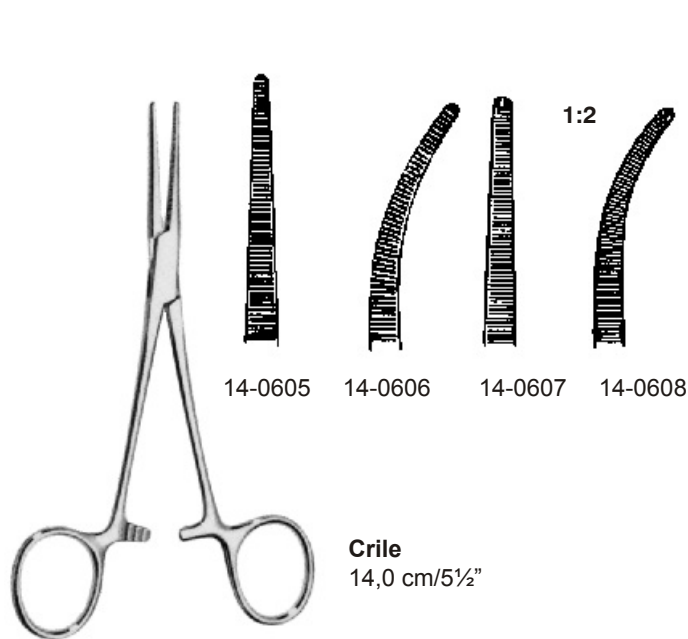
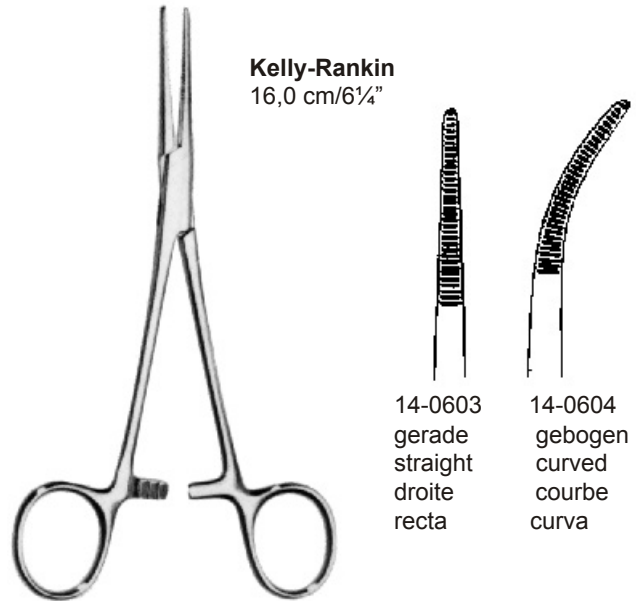
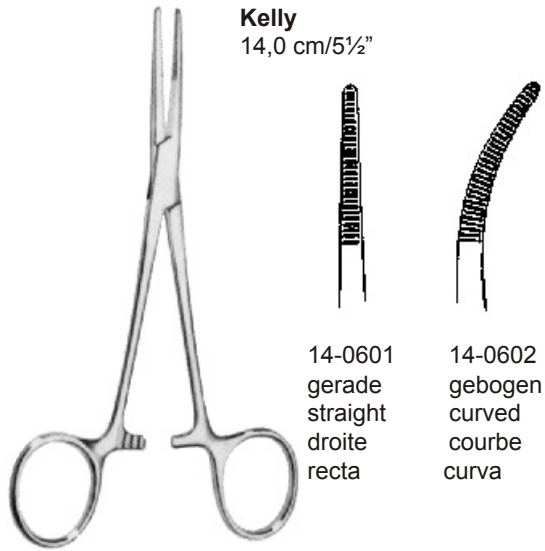



14-0611
gerade
straight
droite
recta

Providence Hospital
14,0 cm/5½"



14-0612
gebogen
curved
courbe
curva

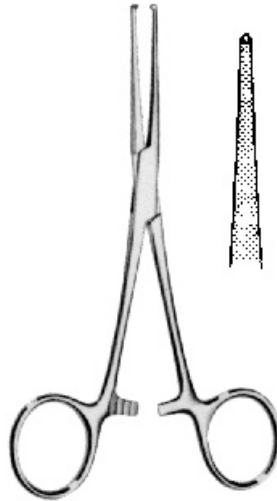

Lovelace
14-0614 15,5 cm/6"

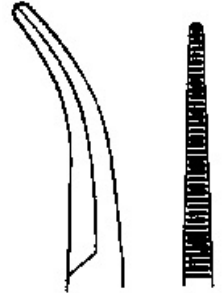

seitwärts gebogen
curved on side
courbe sur le côté
curva lateral

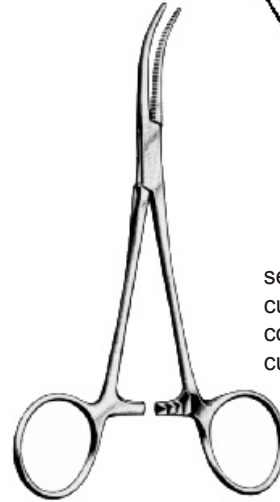

Dandy Crile
14-0615 14,0 cm/5½"

14



14-0617 14,0 cm/5½"
14-0619 16,0 cm/6¼"
gerade
straight
droite
recta

Baby-Crile



14-0618
14-0620
gebogen
curved
courbe
curva



Spencer-Wells



14-0621 13,0 cm/5"
14-0622 14,0 cm/5½"
14-0623 15,5 cm/6"
14-0624 18,0 cm/7"
14-0625 20,0 cm/8"
14-0626 24,0 cm/9"
gerade
straight
droite
recta



14-0627
14-0628
14-0629
14-0630
14-0631
14-0632
gebogen
curved
courbe
curva



14-0634
 gerade
 straight
 droite
 recta

14-0635
 gebogen
 curved
 courbe
 curva

Leriche
 15,0 cm/6"



Pennington

14-0636 15,5 cm/6"
 14-0637 20,0 cm/8"

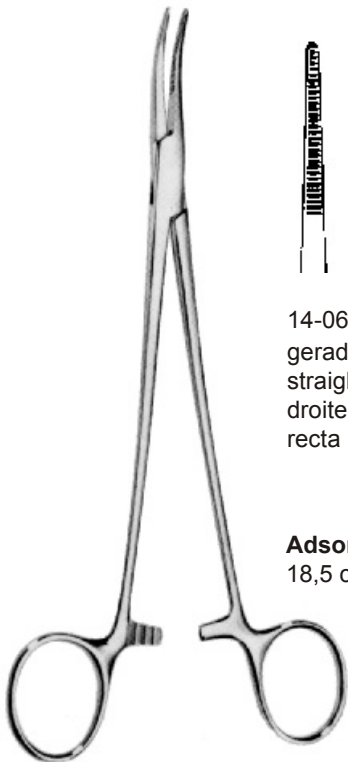

14-0640
 gerade
 straight
 droite
 recta

14-0641
 gebogen
 curved
 courbe
 curva

Adson
 18,5 cm/7¼"

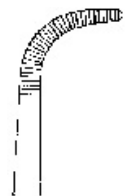
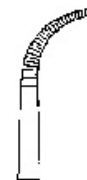

14-0642
 14,0 cm/5½"

14-0643
 18,0 cm/7"

Baby-Adson



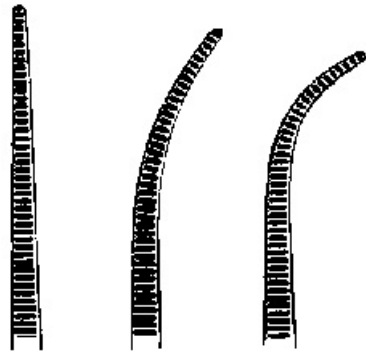

Arterienklemmen
 Hemostatic Forceps
 Pinces hémostatiques
 Pinzas hemostáticas

Fig. 1 14-0644 Fig. 2 14-0645 Fig. 3 14-0646

Heiss
 20,0 cm/8"

Präparier- und Ligaturklemmen, Dissecting and Ligature Forceps
 Pinces à disséquer et à ligatures, Pinzas para preparaciones y ligaduras

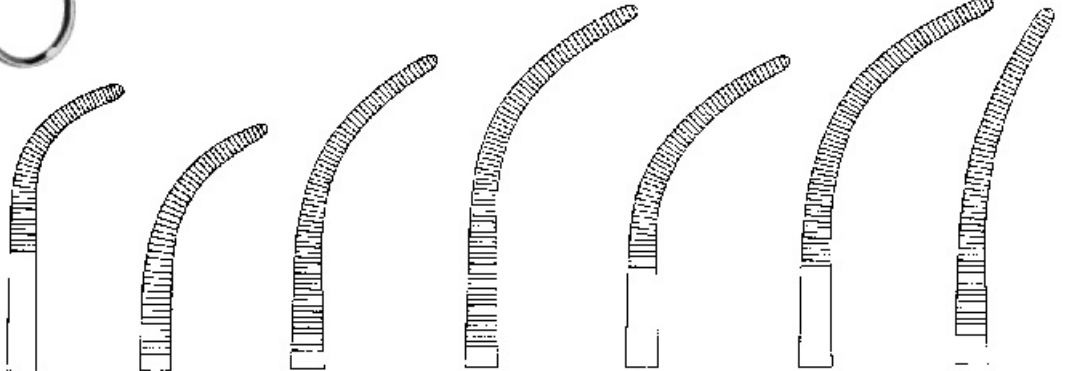
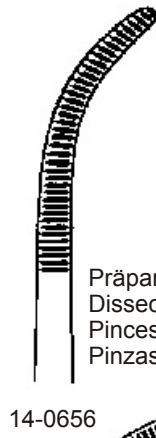
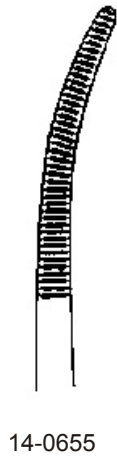
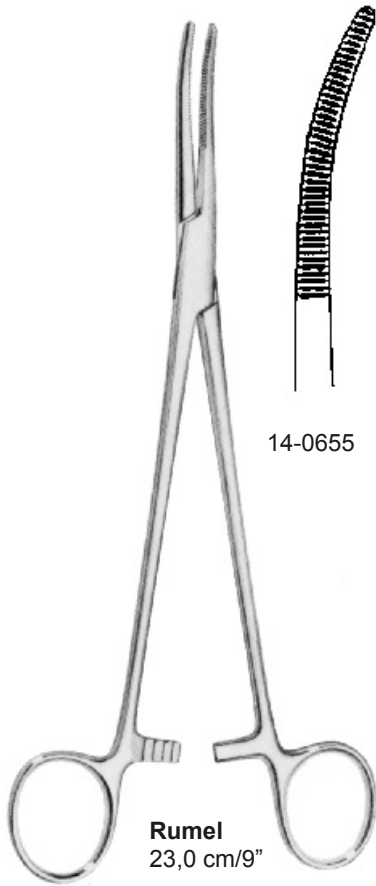

Fig. 1 19,5cm/7¼" 14-0650-01 Fig. 2 21,0cm/8¼" 14-0650-02 Fig. 3 22,0cm/8¾" 14-0650-03
 Fig. 4 22,5cm/9" 14-0650-04 Fig. 5 21,5cm/8½" 14-0650-05 Fig. 6 22,5cm/9" 14-0650-06 Fig. 7 22,5cm/9" 14-0650-07

Fig. 1 26,0cm/10¼" 14-0651-01 Fig. 2 27,0cm/10½" 14-0651-02 Fig. 3 27,5cm/10¾" 14-0651-03
 Fig. 4 27,5cm/10¾" 14-0651-04 Fig. 5 27,5cm/10¾" 14-0651-05 Fig. 6 28,0cm/11" 14-0651-06 Fig. 7 27,5cm/10¾" 14-0651-07

Overholt-Geissendoerfer

14



Präparierklemmen
Dissecting Forceps
Pinces à disséquer
Pinzas para preparaciones

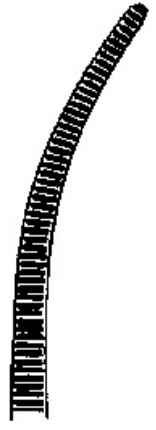
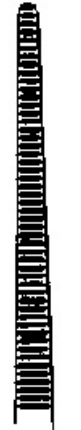
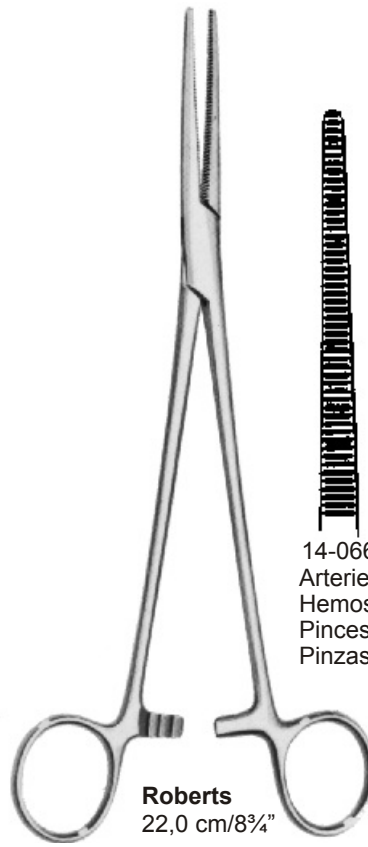
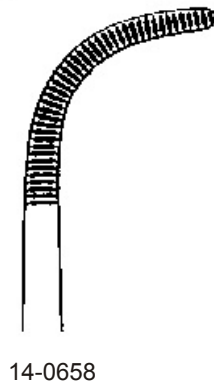
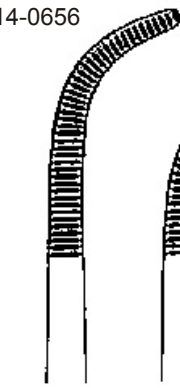

Arterienklemmen
Hemostatic Forceps
Pinces hémostatiques
Pinzas hemostáticas

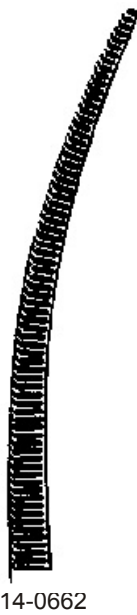

Arterienklemmen
Hemostatic Forceps
Pinces hémostatiques
Pinzas hemostáticas

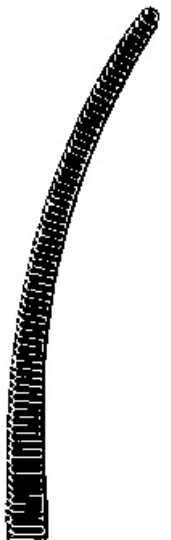
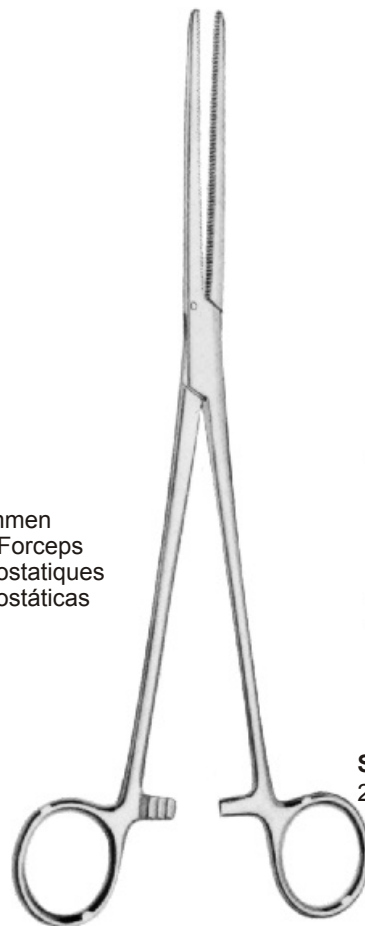



Bengolea

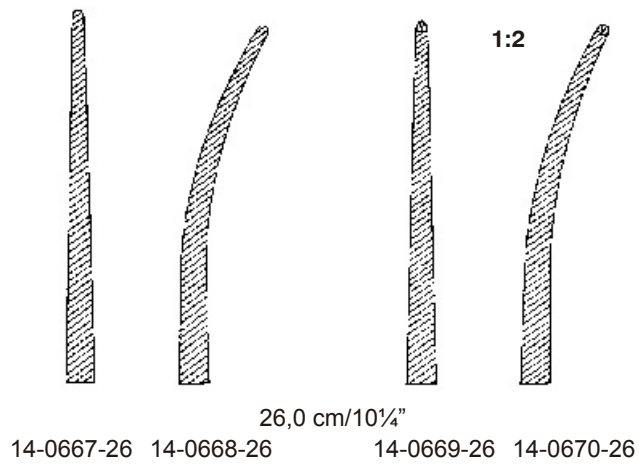
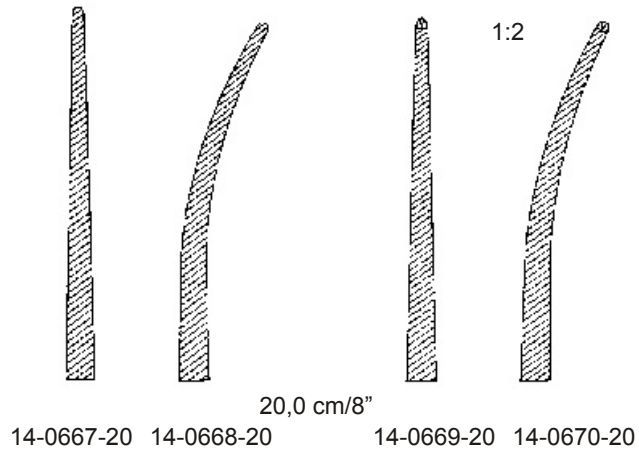



Mini-Gemini

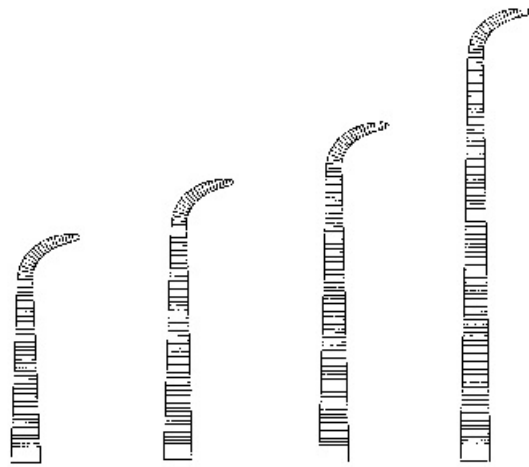

18,0 cm/7"	22,0 cm/8¾"	25,0 cm/10"	28,0 cm/11"
14-0671-18	14-0671-22	14-0671-25	14-0671-28



Gemini

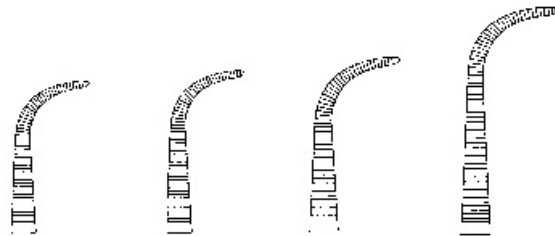

13,0 cm/5"	14,0 cm/5½"	16,0 cm/6¼"	18,0 cm/7"
14-0672-13	14-0672-14	14-0672-16	14-0672-18

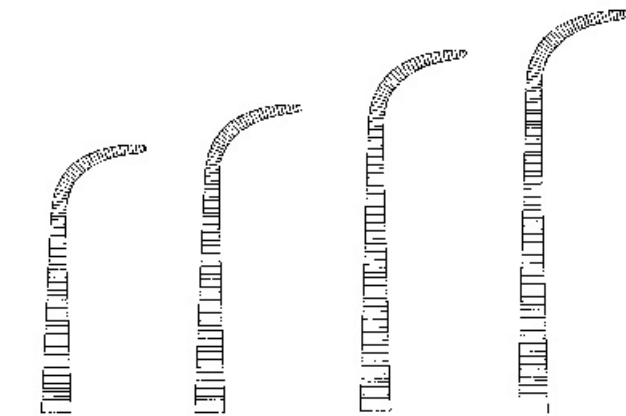

20,0 cm/8"	23,0 cm/9"	25,0 cm/10"	28,0 cm/11"
14-0672-20	14-0672-23	14-0672-25	14-0672-28

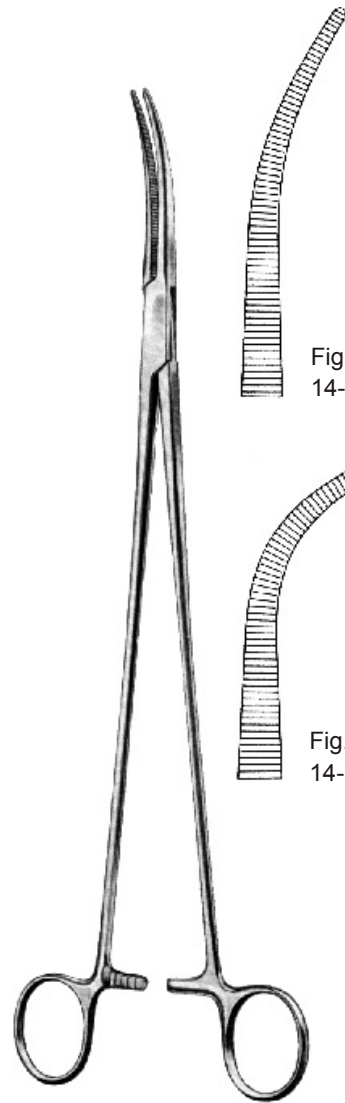

Zenker
 29,5 cm/11½"

Fig. 1
 14-0673-01

Fig. 2
 14-0673-02





Mixer-Baby

14-0675 14,0 cm/5½"
14-0675-18 18,0 cm/7"

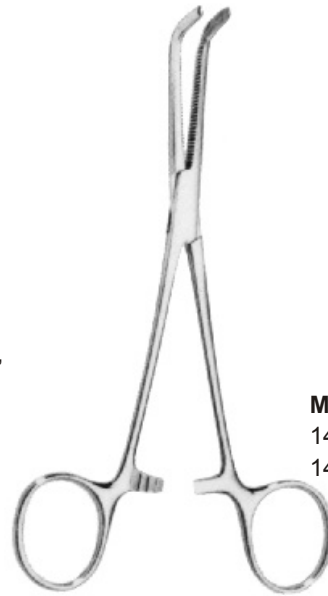

Mixer

14-0676 15,5 cm/6"
14-0677 19,0 cm/7½"

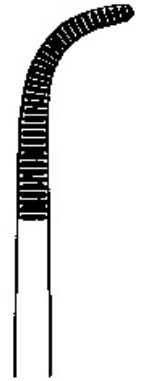
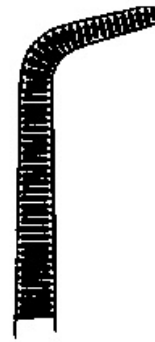

13-0678
22,0 cm/8¾"

14



Mixer-O'Shaugnessy

14-0679 15,5 cm/6"
14-0680 19,0 cm/7½"

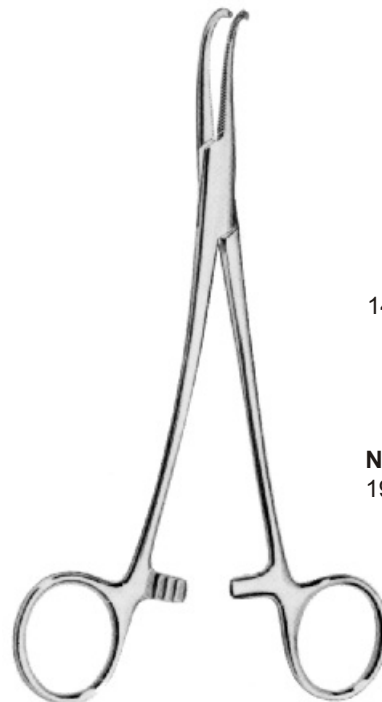
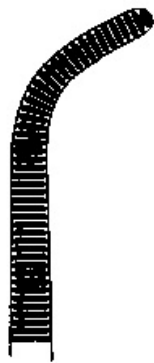

Negus

19,0 cm/7½"

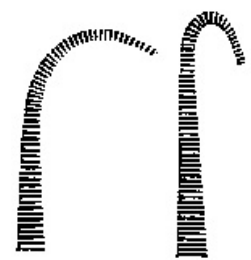

14-0681



14-0682

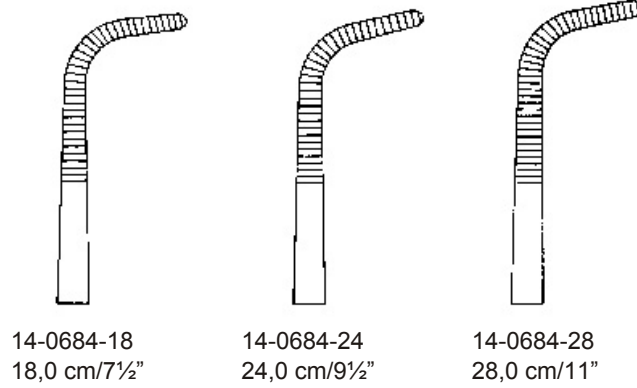

14-0684-18
18,0 cm/7½"

14-0684-24
24,0 cm/9½"

14-0684-28
28,0 cm/11"

Kantrowitz

Gallenkanalklemmen
Gall Duct Clamps
Pinces pour voies biliaires
Pinzas para conductos biliares

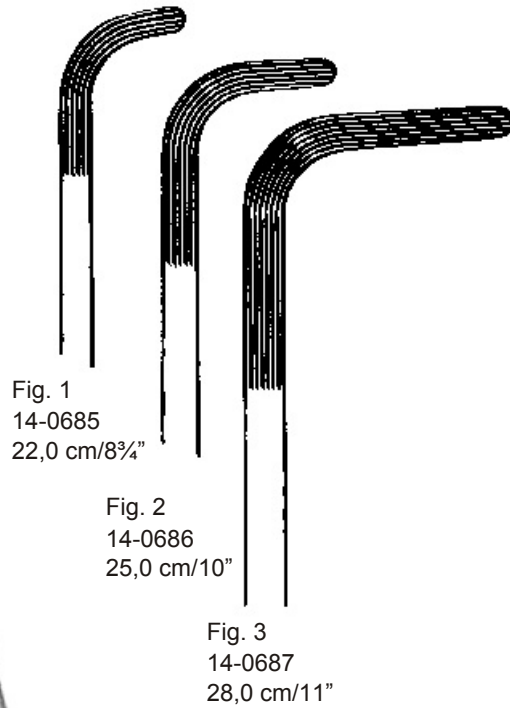
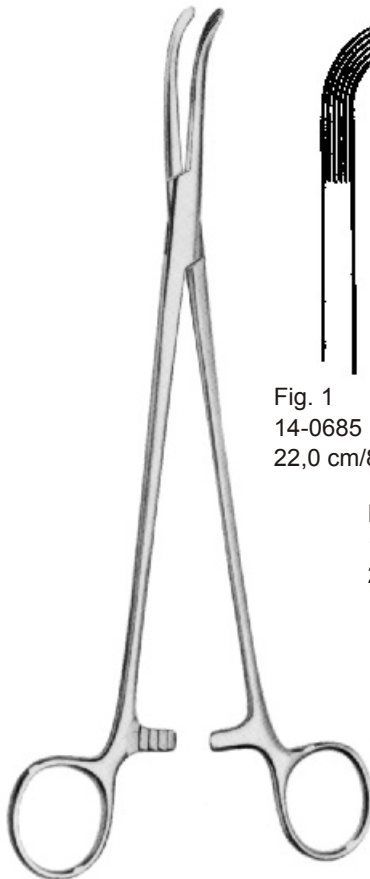
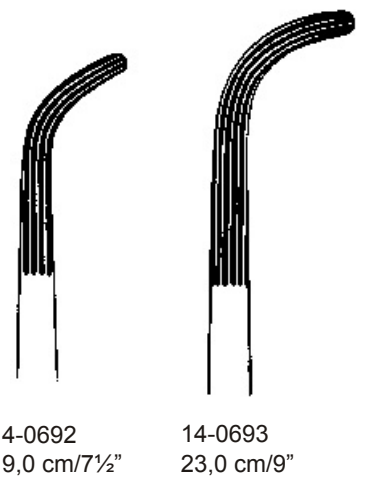
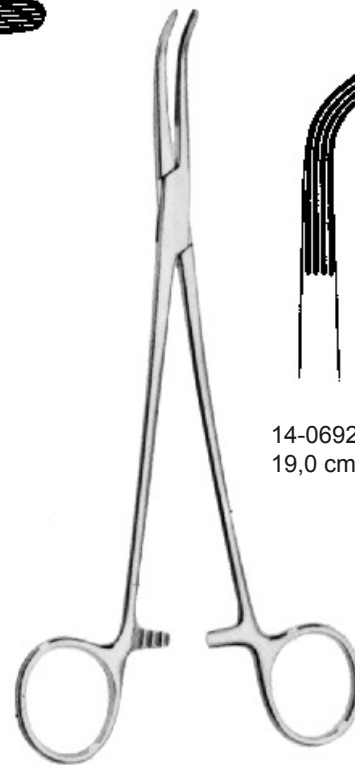

Fig. 1
14-0685
22,0 cm/8¾"

Fig. 2
14-0686
25,0 cm/10"

Fig. 3
14-0687
28,0 cm/11"

Mixer



14-0692
19,0 cm/7½"

14-0693
23,0 cm/9"

Lahey



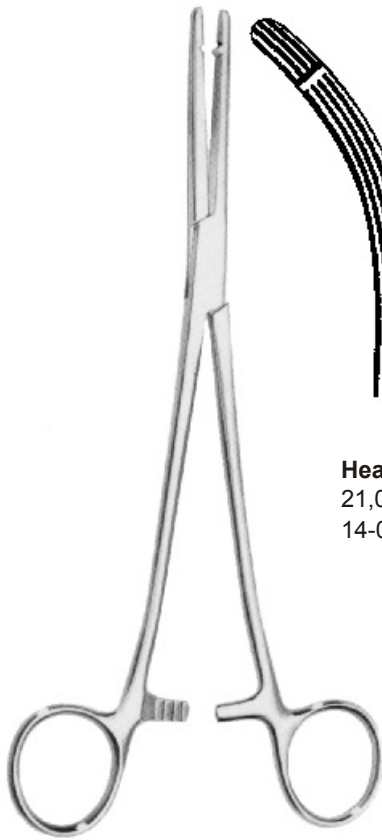

Heaney-Ballentine
21,0 cm/8¼"
14-0712 14-0713

Hysterektomieklemmen
Hysterectomy Forceps
Pinces à hystérectomie
Pinzas para histerectomia



Heaney
14-0716 21,0 cm/8¼"
14-0717 23,0 cm/9" 14-0722
14-0723

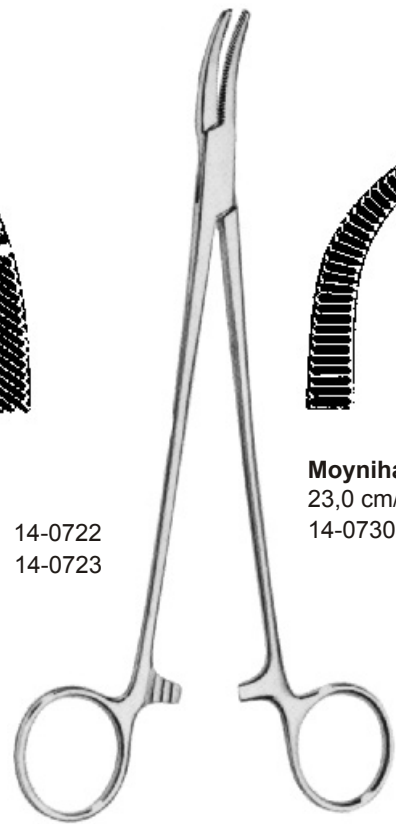

Moynihan
23,0 cm/9"
14-0730

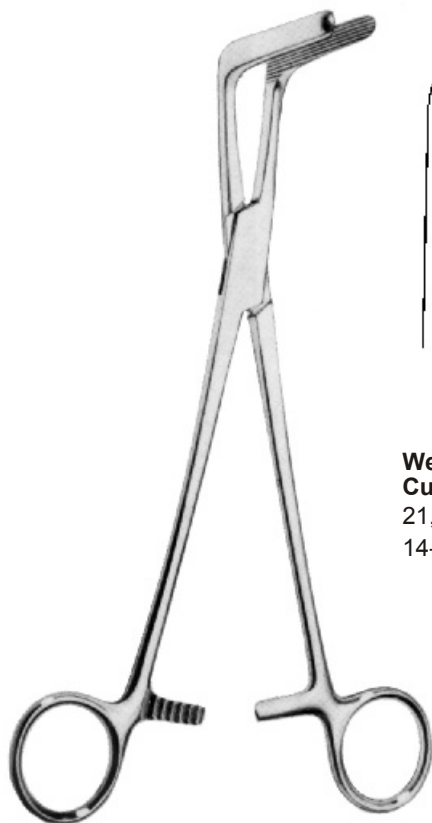
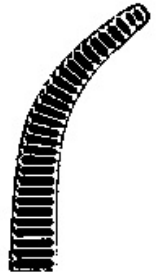

Werheim-Cullen
21,5 cm/8½"
14-0732



Werheim
25,0 cm/10"
14-0733

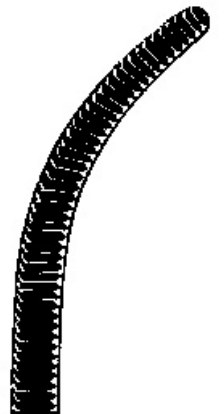

14

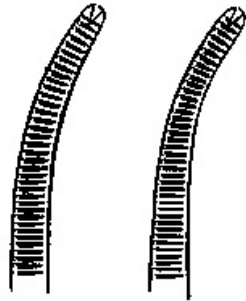

Klemmzangen
 Clamp Forceps
 Pincas clamps
 Pinzas-clamps

Wertheim
 22,0 cm/8³/₄" 23,0 cm/9"
 14-0734 14-0735

Peritoneumklemmen, Peritoneal Clamp Forceps, Pincas pour péritoine, Pinzas para peritoneo

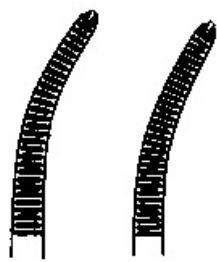

14-0737 14-0738

Mikulicz
 20,0 cm/8"

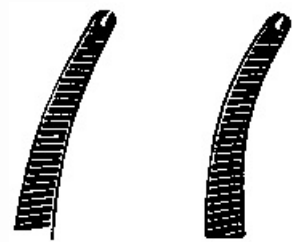

14-0739 14-0740

Faure
 20,0 cm/8"





Schädel
9,0 cm/3½"

14-0761
gebogen
curved
courbe
curva



Jones
14-0762 5,5 cm/2¼"
14-0763 9,0 cm/3½"



Doyen
18,0 cm/7"
14-0764



Peers
14,5 cm/5¾"
14-0770

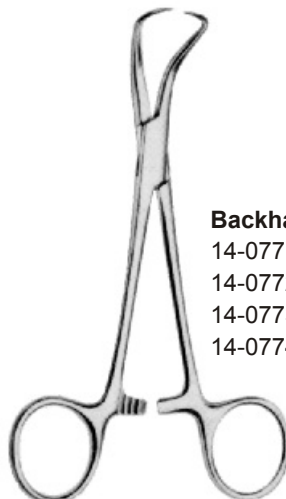

Backhaus
14-0771 9,0 cm/3½"
14-0772 11,0 cm/4½"
14-0773 13,0 cm/5"
14-0774 15,0 cm/6"

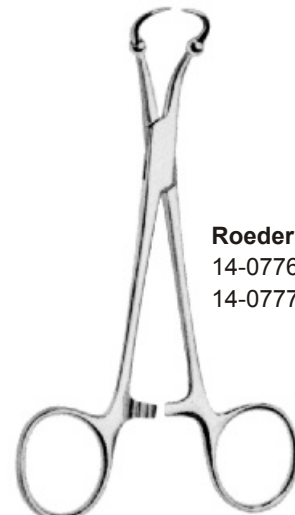

Roeder
14-0776 13,0 cm/5"
14-0777 15,0 cm/6"

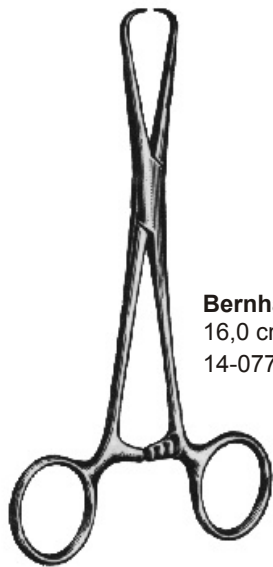

Bernhard
 16,0 cm/6¼"
 14-0778



Lane
 20,0 cm/8"
 14-0780



Lorna
 14-0781 10,0 cm/4"
 14-0782 13,0 cm/5"



Ombredanne
 13,5 cm/5½"
 14-0783

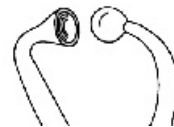

14-0785 11,0 cm/4½"
 14-0786 13,0 cm/5"
 Kugel/Pfanne
 Ball/Socket
 boule/poêle
 bola/paila



14-0787 11,0 cm/4½"
 14-0788 13,0 cm/5"
 Kugel/Kugel
 Ball/Ball
 boule/boule
 bola/bola



Tuchklemmen, Towel Forceps, Pincas à champs, Pinzas de campo

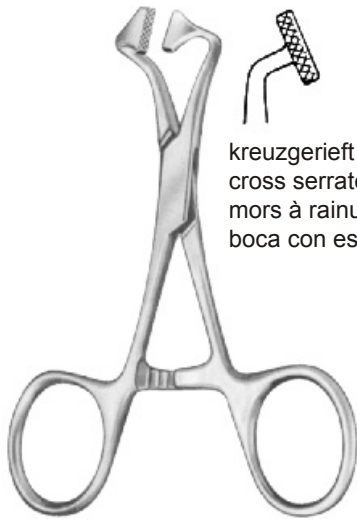

kreuzgerieft
cross serrated
mors à rainures croisées
boca con estrías cruzadas

Thomas

14-0788-10 10,0 cm/4"
14-0788-13 13,0 cm/5"

Schlauchklemmen, Tubing Clamps, Pincas presse-tube, Pinzas para tubos

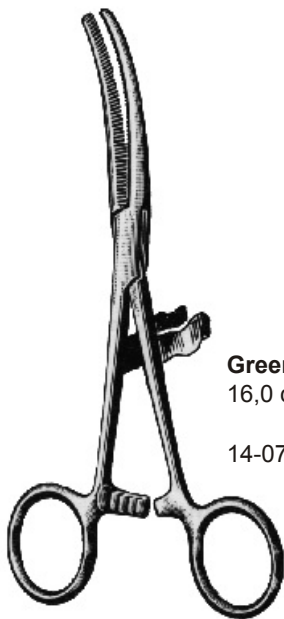

Green
16,0 cm/6¼"
14-0789



Presbyterian
16,0 cm/6½"
14-0790
glatt
smooth
mousse
lisse



14,0 cm/5½"
14-0791



18,0 cm/7"
14-0792



20,0 cm/8"
14-0793

ohne U
without guard
sans protection
sin protección



mit U
with guard
avec protection
con protección



14,0 cm/5½"
14-0796

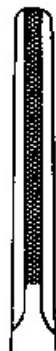

18,0 cm/7"
14-0797

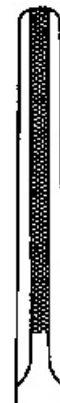

20,0 cm/8"
14-0798





Lister
Sinusklemmen
Sinus Forceps
Pincès à sinus
Pinzas para seno
14-0825 13,0 cm/5"
14-0826 16,0 cm/6¼"
14-0827 18,0 cm/7"

Korn-(Polypen-) zangen, Polypus and Dressing Forceps
Pincès à pansements et à polypes, Pinzas para pólipos y vendajes



14-0821
gerade, straight
droite, recta

Gross
20,0 cm/8"

14-0822
gebogen, curved
courbe, curva

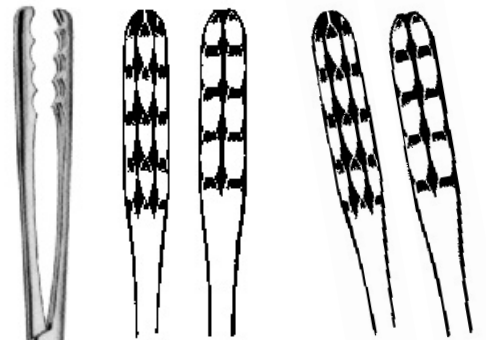

14-0851	22,0 cm/8¾"	14-0853
14-0852	25,0 cm/10"	14-0854
gerade		gebogen
straight		curved
droite		courbe
recta		curva

Tupferzangen
Cotton Swab Forceps
Pincès à tampons
Pinzas para tampones

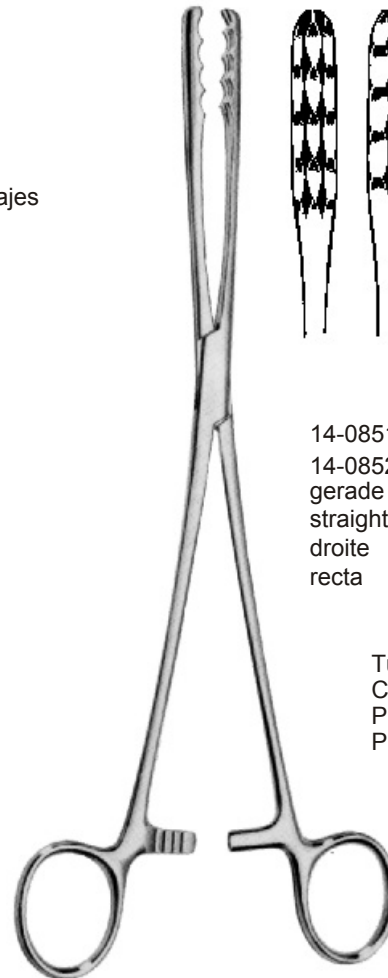

Ulrich





14-0855 22,0 cm/8³/₄" 14-0857
14-0856 25,0 cm/10" 14-0858

Korn-(Polypen-) zangen
Polypus and Dressing Forceps
Pincas à pansements et à polypes
Pinzas para pólipos y vendajes

Maier

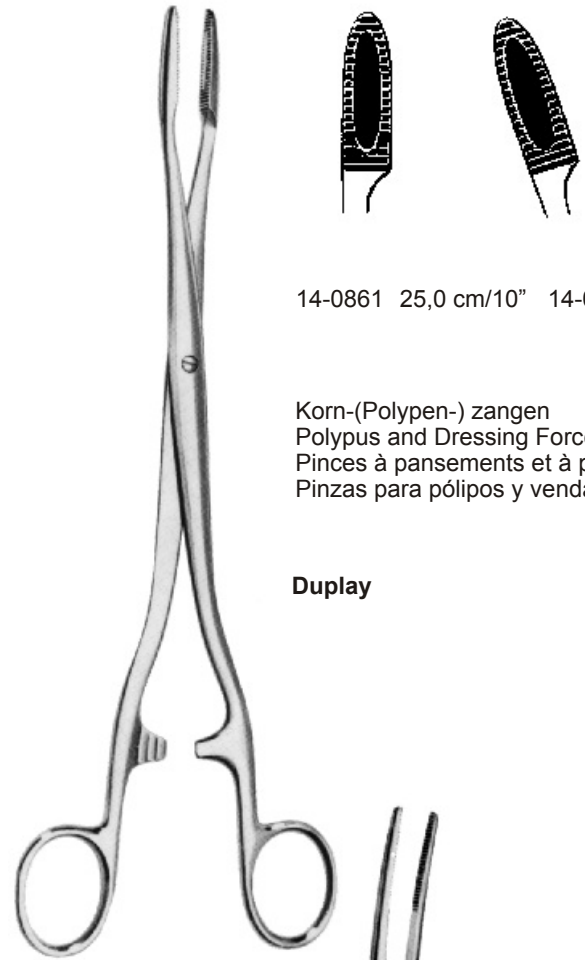

14-0861 25,0 cm/10" 14-0862

Korn-(Polypen-) zangen
Polypus and Dressing Forceps
Pincas à pansements et à polypes
Pinzas para pólipos y vendajes

Duplay

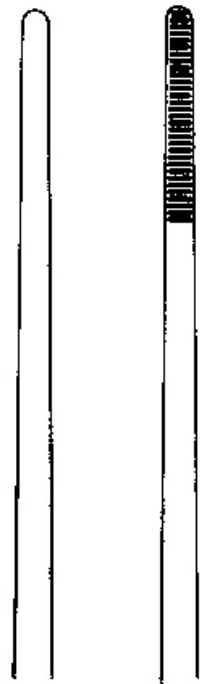

14-0865 14-0866

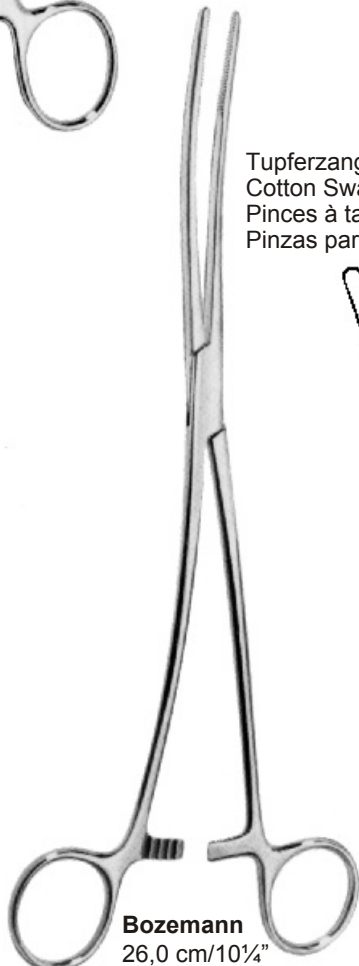

Tupferzangen
Cotton Swab Forceps
Pincas à tampons
Pinzas para tampones

Bozemann
26,0 cm/10¹/₄"

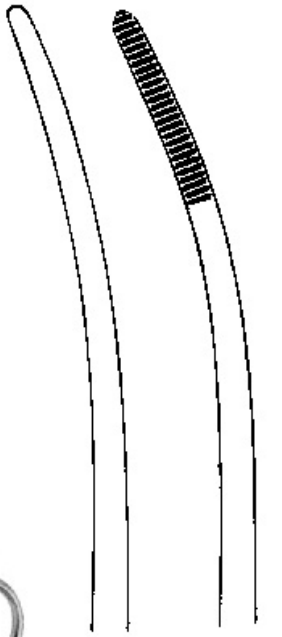

14-0867 14-0868

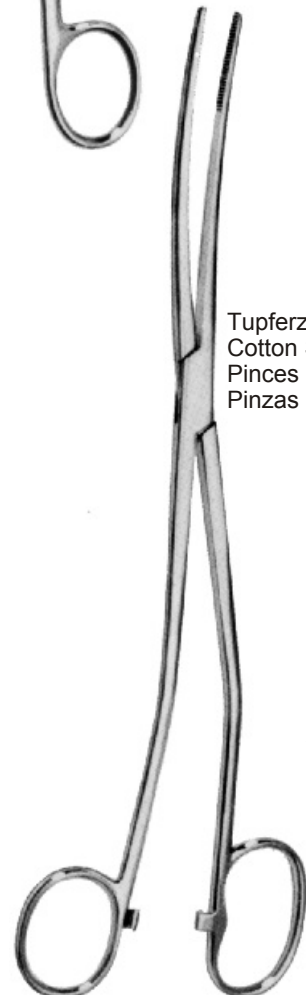

Tupferzangen
Cotton Swab Forceps
Pincas à tampons
Pinzas para tampones

Bozemann-Douglas
26,0 cm/10¹/₄"
14-0869



Tupferzangen
Cotton Swab Forceps
Pinces à tampons
Pinzas para tampones

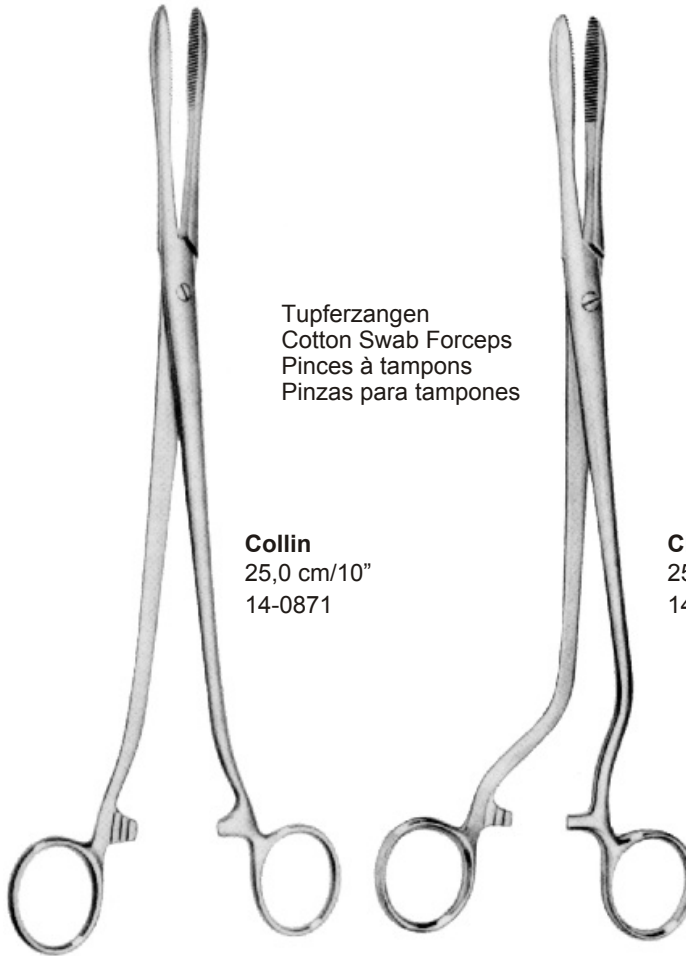

Collin
25,0 cm/10"
14-0871

Cheron
25,0 cm/10"
14-0873

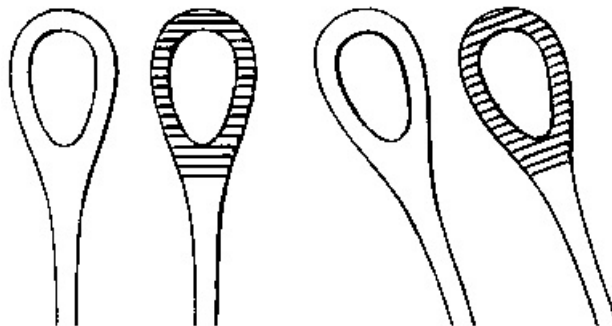

14-0881	14-0884	18,0 cm/7"	14-0887	14-0890
14-0882	14-0885	20,0 cm/8"	14-0888	14-0891
14-0883	14-0886	25,0 cm/10"	14-0889	14-0892

14-0883L 25,0 cm/10"
Isoliert für Laser- und Elektrochirurgie
Insulated for Laser- and Electrosurgery
Isolé pour les interventions au laser et électrochirurgical
Aislado para láser y electrocirugía

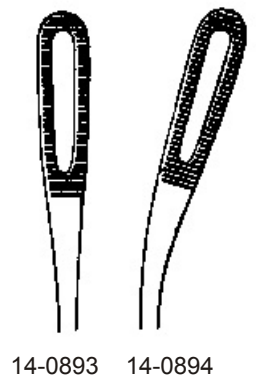

14-0893 14-0894

Foerster
25,0 cm/10"
schmal
narrow
étroite
estrecha

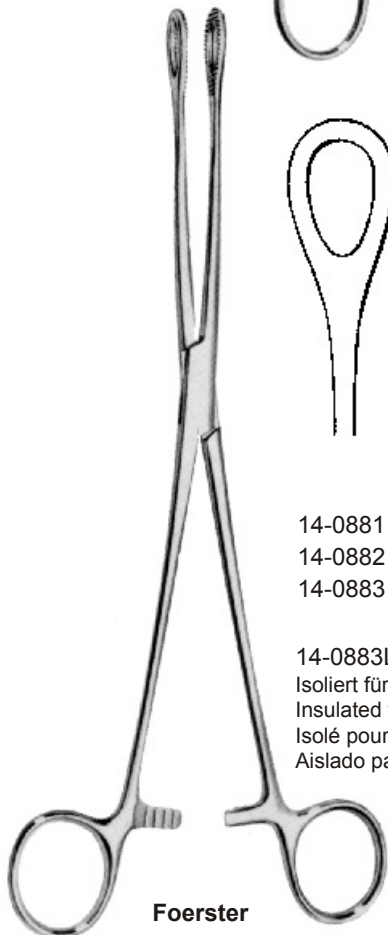
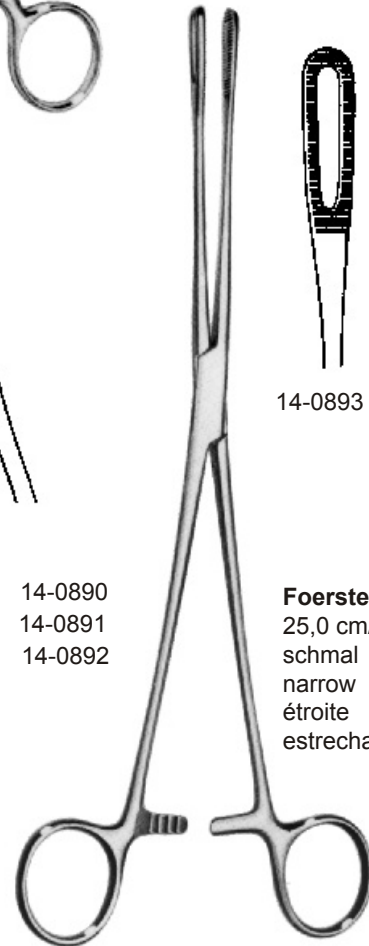

Foerster

14

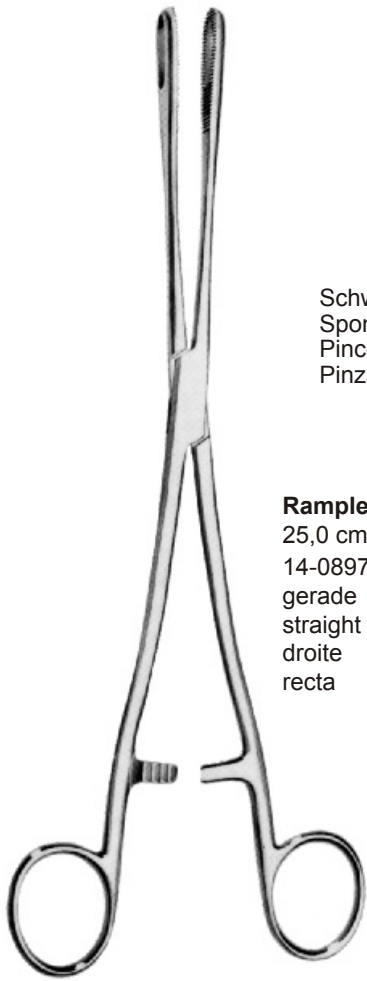

Schwammzange
Sponge Holding Forceps
Pinces à éponges
Pinzas porta-esponjas

Rampley
25,0 cm/10"
14-0897 14-0898
gerade gebogen
straight curved
droite courbe
recta curva



Sterilisierzange
Sterilizing Forceps
Pinces à stérilisation
Pinzas para esterilización

Davis
Sterilisierpinzette
Sterilizing Forceps
Pinces à stérilisation
Pinzas para esterilización
14-0901 16,0 cm/6¼"
14-0902 20,0 cm/8"
14-0903 24,0 cm/9½"

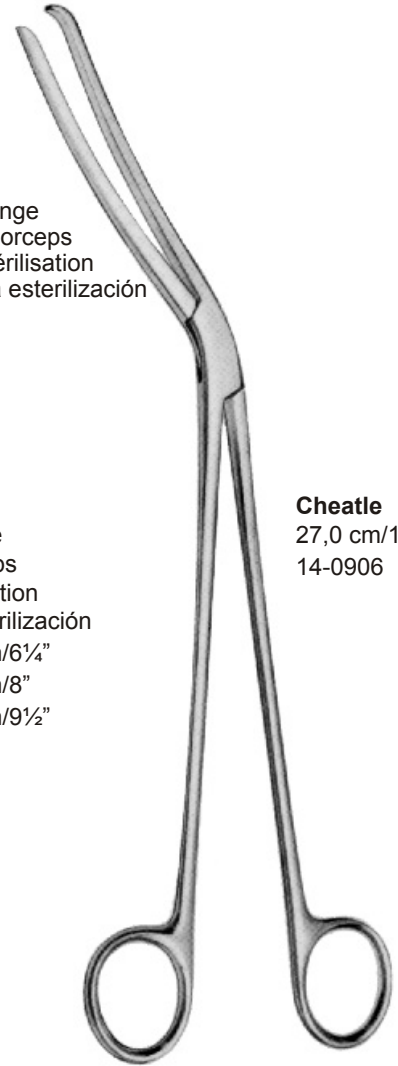

Cheatle
27,0 cm/10½"
14-0906

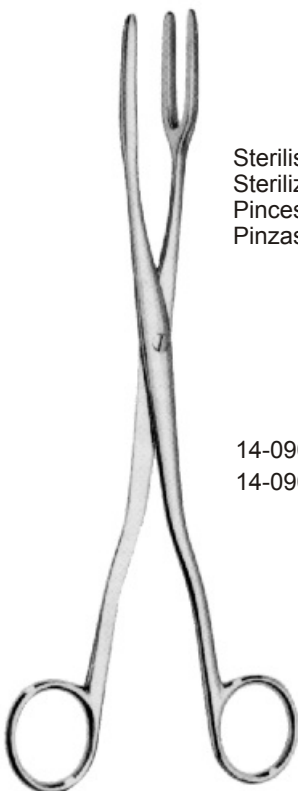

Sterilisierzange
Sterilizing Forceps
Pinces à stérilisation
Pinzas para esterilización

14-0907 20,0 cm/8"
14-0908 30,0 cm/12"

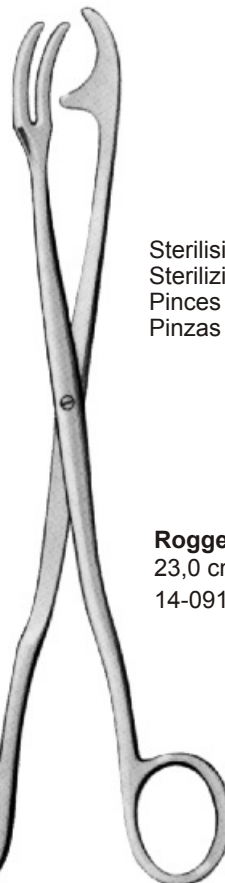

Sterilisierzange
Sterilizing Forceps
Pinces à stérilisation
Pinzas para esterilización

Rogge
23,0 cm/9"
14-0910





15

Keys

- 15-0922 (2 mm)
- 15-0923 (3 mm)
- 15-0924 (4 mm)
- 15-0925 (5 mm)
- 15-0926 (6 mm)
- 15-0927 (7 mm)
- 15-0928 (8 mm)

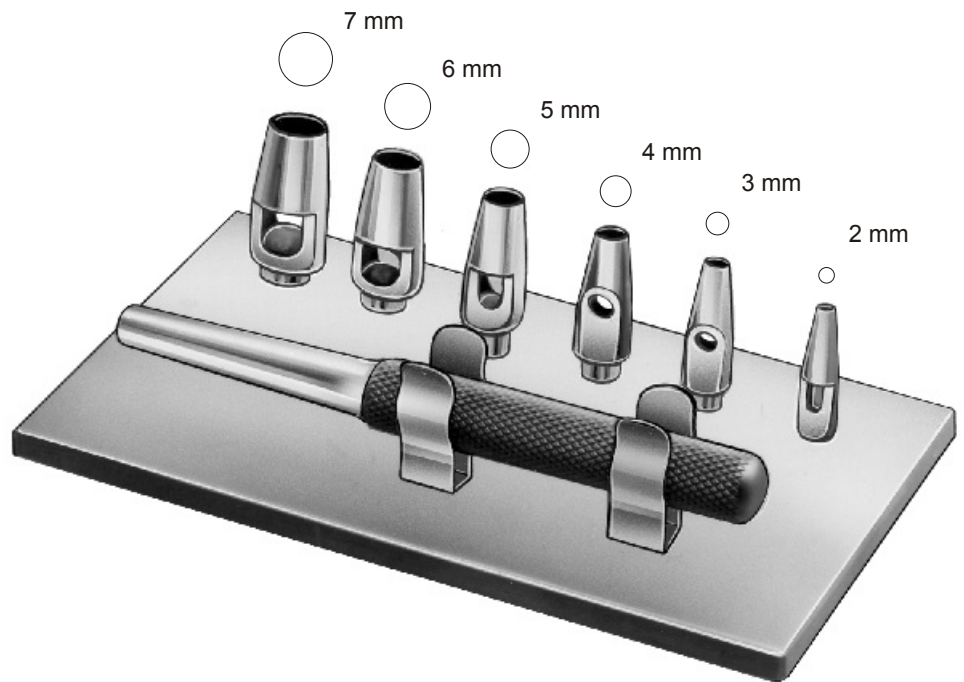

Keys Set

15-0930
Hautstanze komplett, mit 6 auswechselbaren Stanzköpfen
Dermal Punch complete, with 6 interchangeable tips
Trépan cutané complet, avec 6 embouts interchangeables
Trépanos cutáneos completos, con 6 puntas intercambiables

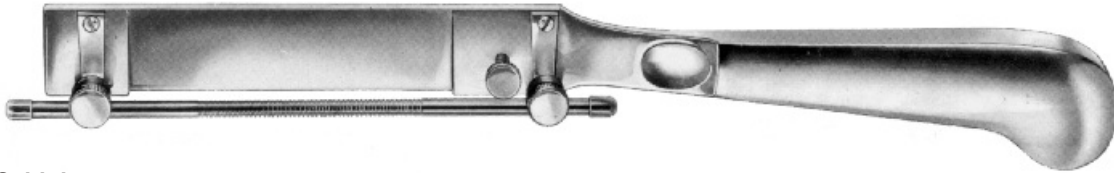

Schink

1/2

15-0950

30,0 cm/12"

Dermatom, einstellbar von 0,1 - 2,0 mm, komplett, mit 1 auswechselbarer Klinge und 2 Spannplatten

Dermatome, adjustable from 0,1 to 2,0 mm, complete, with 1 interchangeable blade and 2 skin straightening blades

Dermatome, réglable en épaisseur de 0,1 à 2,0 mm, complet, avec 1 lame interchangeable et 2 plaques pour tendre la peau

Dermátomo, graduable de 0,1 hasta 2,0 mms, completo, con 1 hoja intercambiable y 2 placas para extender la piel

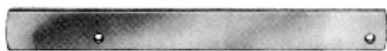

15-0951

1/2

Ersatzklinge, allein

Spare blade only

Lame de rechange, seule

Hoja de repuesto, suelta

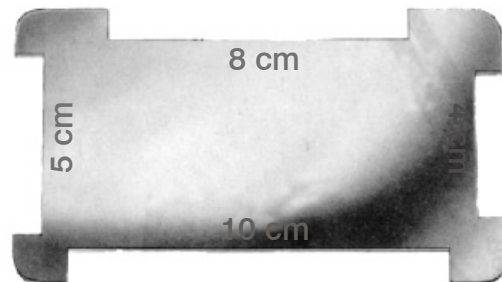

15-0952

1/2

Spannplatte, allein

Skin straightening plate only

Plaque pour tendre la peau, seule

Placa para extender la piel, suelta



Silver

1/2

15-0953

19,0 cm/7 1/2"

Dermatom

Dermatome

Dermátomo

Dermátomo



Lupusküretten
 Lupus curettes
 Curettes pour le lupus
 Curetas para lupus

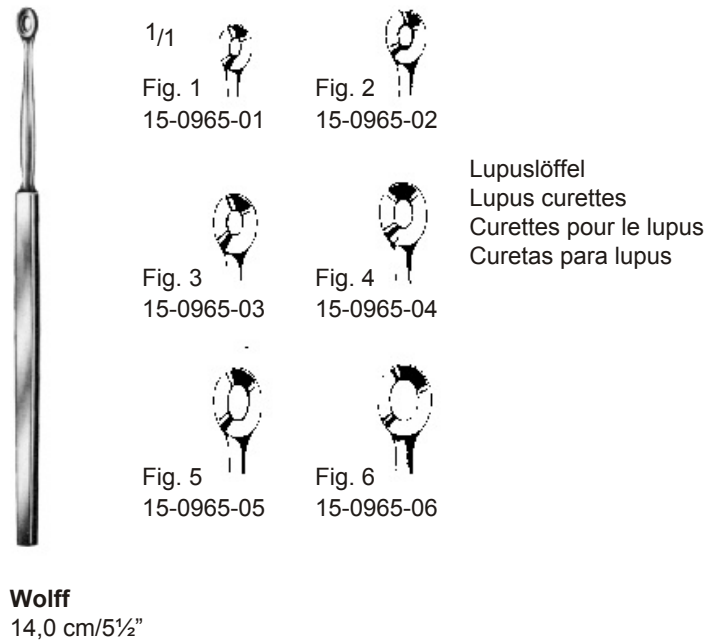
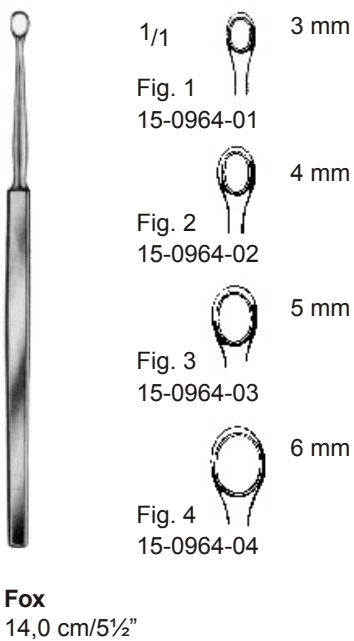



Unna
14,5 cm/5½"
oval, oval
ovale, oval
15-0966

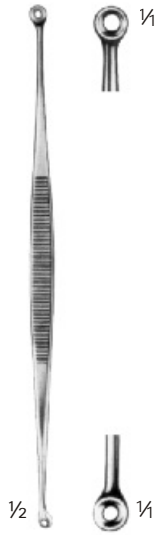

Unna
14,5 cm/5½"
rund, round
ronde, redondo
15-0967



Saalfeld
11,0 cm/4"
15-0968-11



Saalfeld
14,5 cm/6"
15-0968-14



Schamberg
9,5 cm/4"
15-0969

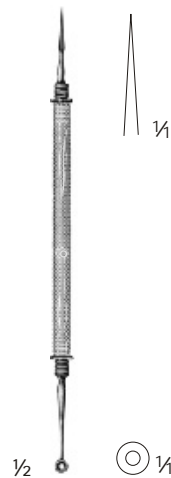

Unna-Vidal
11,5 cm/4½"
15-0970



Messer, Skalpele
Knives, Scalpels
Couteaux, Bistouris
Cuchillos, Bisturías





1/4

Fig. 1

16-1001

1/4

Fig. 2

16-1002

1/4

Fig. 3

16-1003

1/4

Fig. 4

16-1004

1/4

Fig. 5

16-1005

1/4

Fig. 6

16-1006

1/4

Fig. 7

16-1007

1/4

Fig. 8

16-1008

1/4

Fig. 9

16-1009

17,0 cm/6³/₄"
massiv
solid
massif
macizo



1/4

Fig. 10

16-1010

1/4

Fig. 11

16-1011

1/4

Fig. 12

16-1012

1/4

Fig. 13

16-1013

1/4

Fig. 14

16-1014

1/4

Fig. 15

16-1015

1/4

Fig. 16

16-1016

1/4

Fig. 17

16-1017

1/4

Fig. 18

16-1018



Fig. 26
16-1026



Fig. 27
16-1027



Fig. 32
16-1032



Fig. 36
16-1036



Fig. 37
16-1037



Fig. 38
16-1038



Fig. 40
16-1040



Fig. 46
16-1046



Fig. 60
16-1060



Fig. 61
16-1061



Fig. 62
16-1062



Fig. 63
16-1063



Collin
 15,0 cm/6"
 Fig. 1-6

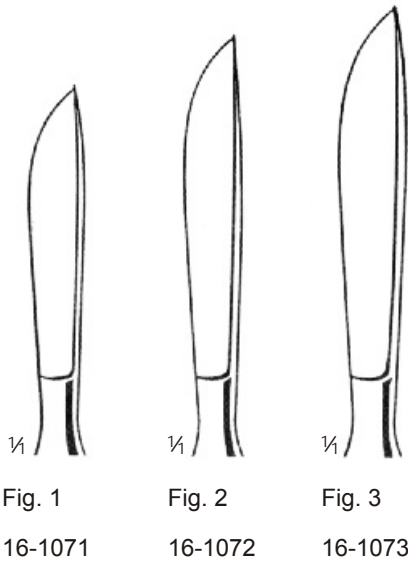

Fig. 1
16-1071

Fig. 2
16-1072

Fig. 3
16-1073

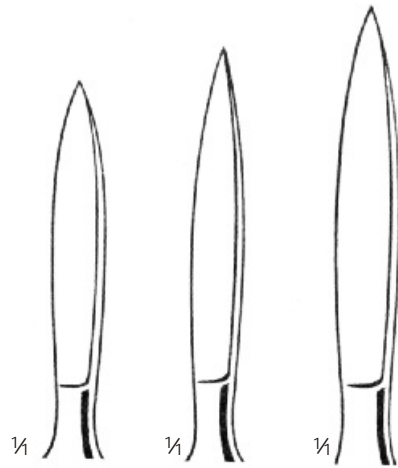

Fig. 4
16-1074

Fig. 5
16-1075

Fig. 6
16-1076



Dieffenbach
 17,0 cm/6³/₄"
 Fig. 1-9

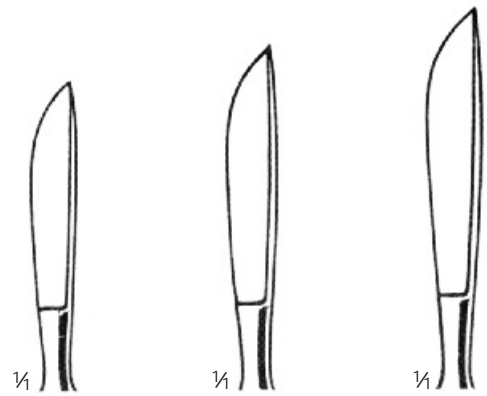

Fig. 1
16-1081

Fig. 2
16-1082

Fig. 3
16-1083

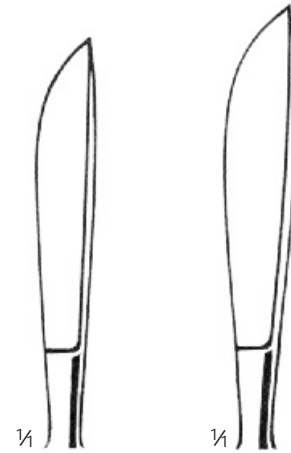

Fig. 4
16-1084

Fig. 5
16-1085

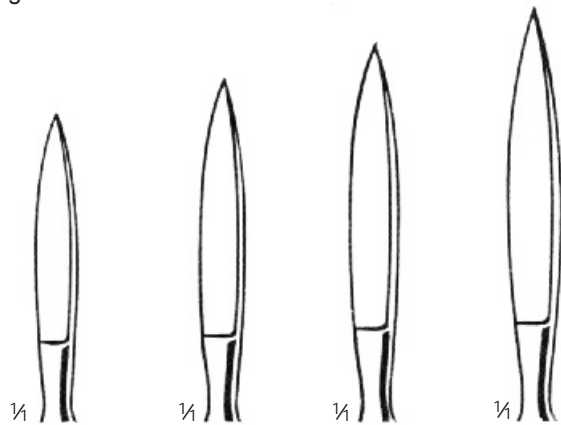

Fig. 6
16-1086

Fig. 7
16-1087

Fig. 8
16-1088

Fig. 9
16-1089



Standard
 16-1091
 No. 3
 massiv
 solid
 massif
 macizo



16-1092
 No. 3L
 massiv
 solid
 massif
 macizo



16-1092G
 No. 3L
 massiv, abgewinkelt
 solid, angular
 massif, coudé
 macizo, acodado



Standard
 16-1095
 No. 4
 massiv
 solid
 massif
 macizo



16-1096
 No. 4L
 massiv
 solid
 massif
 macizo

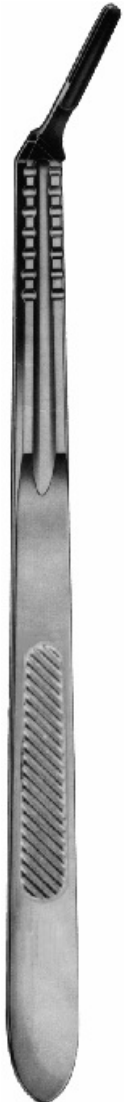

16-1096G
 No. 4L
 massiv, abgewinkelt
 solid, angular
 massif, coudé
 macizo, acodado



Standard
16-1097
No. 7
massiv
solid
massif
macizo



16-1097K
No. 7K
massiv
solid
massif
macizo

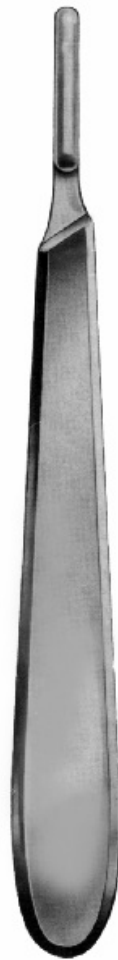

16-1098
No. 8
hohl
hollow
creux
hueco

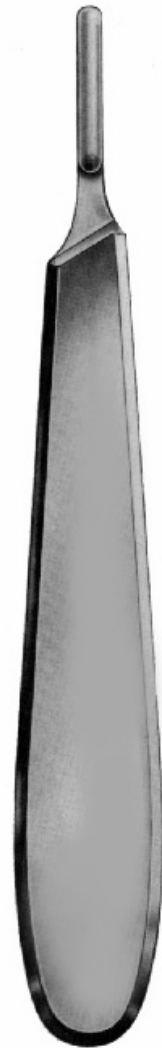

16-1099
No. 9
hohl
hollow
creux
hueco

106

steril
 sterile
 stériles
 estériles

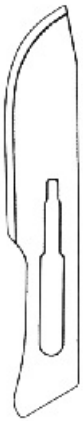

Fig. 10
Standard

16-1110

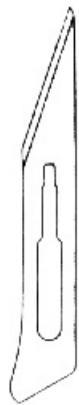

Fig. 11
Standard

16-1111



Fig. 12
Standard

16-1112



Fig. 13
Standard

16-1113

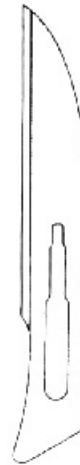

Fig. 14
Standard

16-1114

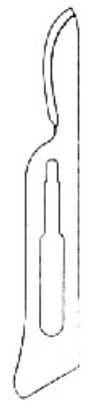

Fig. 15
Standard

16-1116

steril
 sterile
 stériles
 estériles

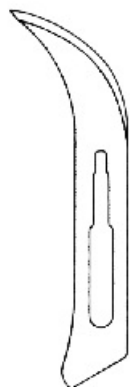

Fig. 16
Standard

16-1116



Fig. 17
Standard

16-1117

Verkaufseinheit: Pack à 100 Stück
 Sales unit: Package of 100 pieces
 Quantité de vente: Paquet de 100 pièces
 Unidad de venta: Paquet de 100 piezas



steril
 sterile
 stériles
 estériles



Fig. 18
Standard

16-1118



Fig. 19
Standard

16-1119



Fig. 20
Standard

16-1120

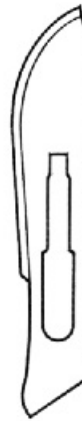

Fig. 21
Standard

16-1121



Fig. 22
Standard

16-1122



Fig. 23
Standard

16-1123



steril
 sterile
 stériles
 estériles



Fig. 24
Standard

16-1124



Fig. 25
Standard

16-1125



Fig. 34
Standard

16-1134



Fig. 36
Standard

16-1136

Verkaufseinheit: Pack à 100 Stück
 Sales unit: Package of 100 pieces
 Quantité de vente: Paquet de 100 pièces
 Unidad de venta: Paquet de 100 piezas



Lappenmesser
Flap knife
Couteau lobaire
Cuchilla para lóbulos

Phalangenmaesser
Phalangeal knife
Couteau à phalanges
Cuchilla para falanges

Zwischenknochen-
messer
Interosseous knife
Couteaux interosseux
Cuchillas interóseos

Catlin

Liston

Langenbeck

Schnittlänge
Length of blades
Longueur des lames
Largo de hojas
cm in.

9,5	3¾					16-1187	
11,0	4½						16-1188
12,0	4¾					16-1185	
13,0	5	16-1171				16-1186	
16,0	6¼	16-1172	16-1175				
17,0	6¾			16-1178			
19,0	7½	16-1173	16-1176				
20,0	8			16-1179			
22,0	8¾	16-1174	16-1177				



Langenbeck
geballt, bellied
convexe, convexo



Langenbeck
spitz, pointed
pointu, agudo



Seziermesser
Autopsy knife
Couteau à autopsie
Cuchillo para autopsia

mit Schaber
with dissector
avec rugine
con raspador

Schnittlänge
Length of blades
Longueur des lames
Largo de hojas

cm	in.		
5,5	2¼	16-1189	16-1190
6,5	2½		16-1191

16



Organmesser
 Post mortem knife
 Couteau à autopsie
 Cuchillo para órganos

Walb

Schnittlänge	16-1194-11	11,0 cm/4½"
Length of blades	16-1194-14	14,0 cm/5½"
Longueur des lames	16-1194-17	17,0 cm/6¾"



Hirnmesser
 Brain knife
 Couteau à cerveau
 Cuchillo para cerebro

Virchow

16-1195-16	16,0 cm/6¼"
16-1195-20	20,0 cm/8"
16-1195-24	24,0 cm/9½"



Schnittlänge
Length of blades
Longueur des lames
Largo de hojas

9,0 cm/3½"



Virchow

16-1196
Metallgriff
Metal handle
Manche en métal
Mango de metal

9,0 cm/3½"



Virchow

16-1197
Holzgriff
Wooden handle
Manche en bois
Mango de madera

12,0 cm/4¾"



16-1198
Holzgriff
Wooden handle
Manche en bois
Mango de madera

20,0 cm/8"



16-1199
Metaalgriff
Metal handle
Manche en métal
Mango de metal

106

**Rektum Instrumente
Rectal Instruments
Instruments Rectaux
Instrumentos Rectales**



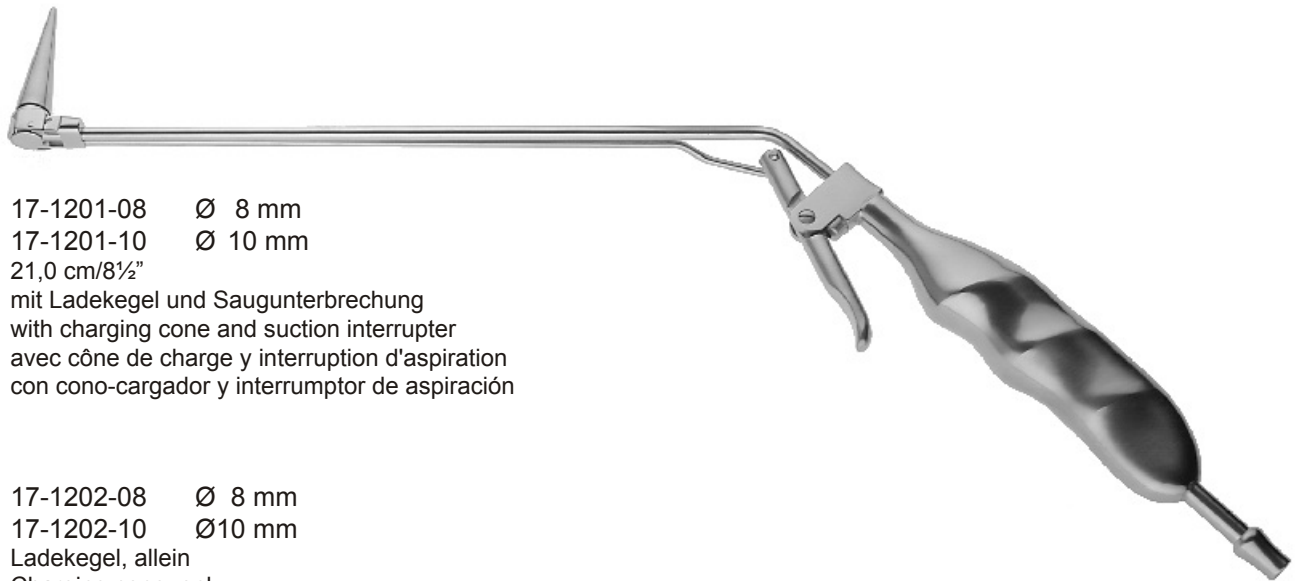

17-1201-08 Ø 8 mm
17-1201-10 Ø 10 mm
21,0 cm/8½"
mit Ladekegel und Saugunterbrechung
with charging cone and suction interrupter
avec cône de charge y interruption d'aspiration
con cono-cargador y interruptor de aspiración

17-1202-08 Ø 8 mm
17-1202-10 Ø 10 mm
Ladekegel, allein
Charging cone, only
Cône de charge, seul
Cono-cargador, suelto

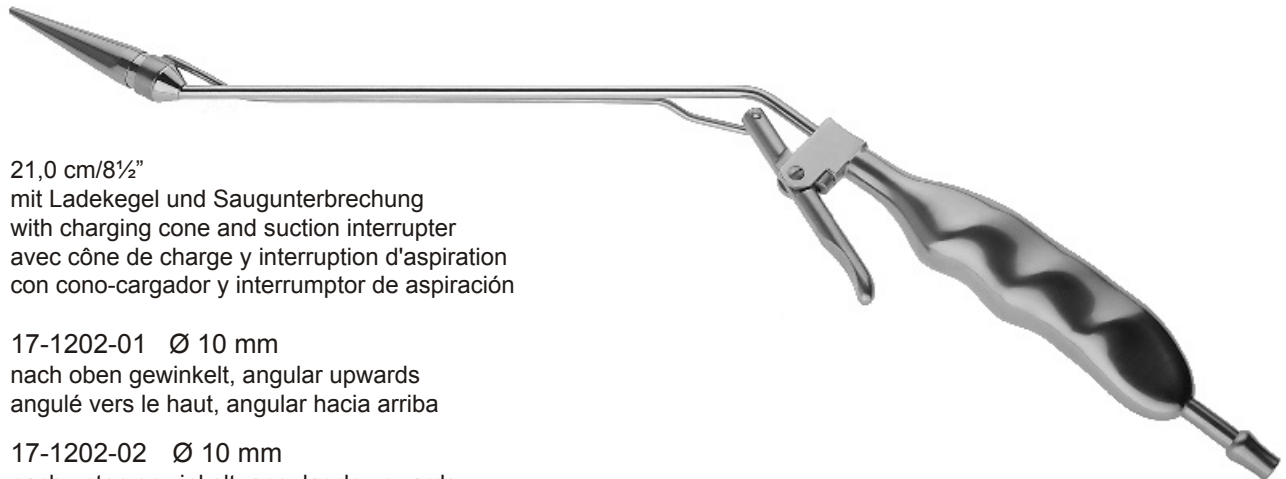

21,0 cm/8½"
mit Ladekegel und Saugunterbrechung
with charging cone and suction interrupter
avec cône de charge y interruption d'aspiration
con cono-cargador y interruptor de aspiración

17-1202-01 Ø 10 mm
nach oben gewinkelt, angular upwards
angulé vers le haut, angular hacia arriba

17-1202-02 Ø 10 mm
nach unten gewinkelt, angular downwards
angulé vers le bas, angular hacia abajo

17-1202-10
Ladekegel 10 mm
Charging cone 10 mm
Cône de charge 10 mm
Cono-cargador 10 mm

17-1203-05
Ligatur-Gummiringe, Packung à 100 Stück
Ligatur rubber rings in package of 100 pieces
Bagues de caoutchouc pour ligatures, paquet de 100 pièces
Arandelas de goma para ligadura en paquete de 100 unidades

Auf Anfrage auch mit Kaltlichtanschluß lieferbar. On request, also available with coldlight connection.
A demande aussi livrable avec connexion de lumière froide. A demanda se puede también suministrar con conexión de luz fría.



17-1203-01
mit Ladekegel 12 mm, leicht zerlegbar
with charging cone 12 mm, easily dismantable
avec cône de charge 12 mm, facilement
démontable
con cono-cargador 12 mm, facilmente
desmontable

17-1203-12
Ladekegel 12 mm
Charging cone 12 mm
Cône de charge 12 mm
Cono-cargador 12 mm

17-1203-05
Ligatur-Gummiringe, Packung à 100 Stück
Ligatur rubber rings in package of 100 pieces
Bagues de caoutchouc pour ligatures,
paquet de 100 pièces
Arandelas de goma para ligadura en paquete
de 100 unidades

Hämorrhoidal-Faßzangen, Hämorrhoidal Forceps, Pincés pour saisir les hémorroïdes, Pinzas hemorroidales



McGivney
17-1204-01
19,0 cm/7½"



McGivney
17-1204-02
19,0 cm/7½"

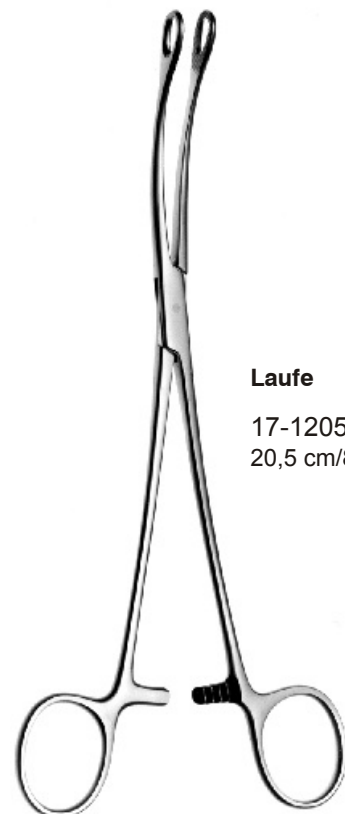

Laufe
17-1205-20
20,5 cm/8¼"



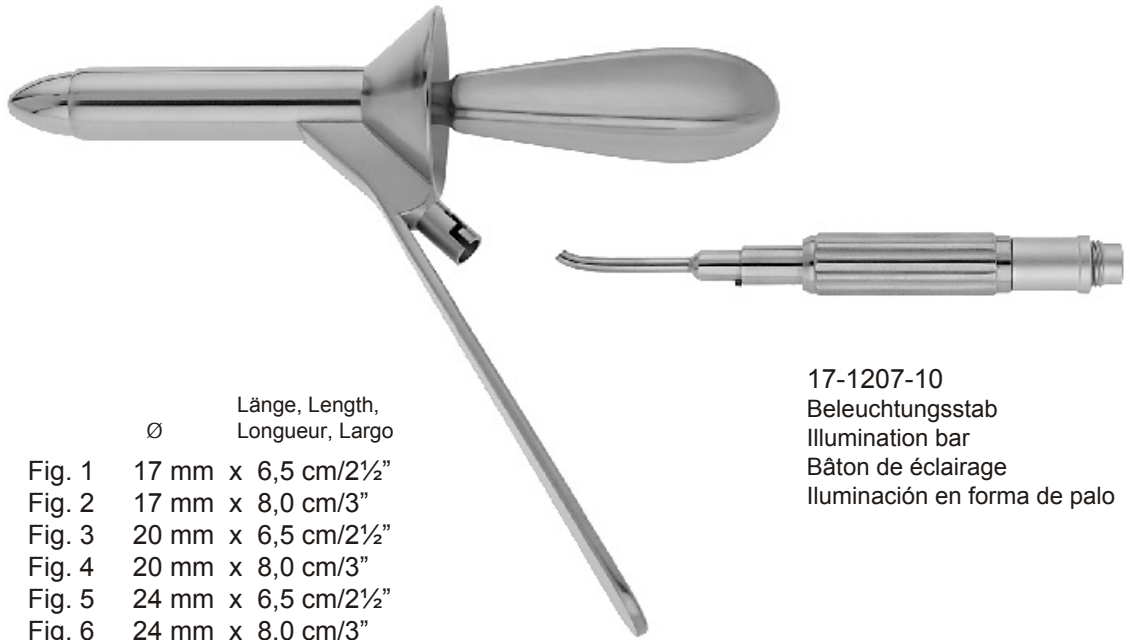

Morgan

		∅	Länge, Length, Longueur, Largo
17-1207-01	Fig. 1	17 mm	6,5 cm/2½"
17-1207-02	Fig. 2	17 mm	8,0 cm/3"
17-1207-03	Fig. 3	20 mm	6,5 cm/2½"
17-1207-04	Fig. 4	20 mm	8,0 cm/3"
17-1207-05	Fig. 5	24 mm	6,5 cm/2½"
17-1207-06	Fig. 6	24 mm	8,0 cm/3"

17-1207-10
Beleuchtungsstab
Illumination bar
Bâton de éclairage
Iluminación en forma de palo



Anuscope
Anusopes
Anusopes
Anuscopios



Hirschmann

		∅	Länge, Length, Longueur, Largo
17-1208-01	Fig. 1	16 mm	6,5 cm/2½"
17-1208-02	Fig. 2	19 mm	6,5 cm/2½"
17-1208-03	Fig. 3	22 mm	6,5 cm/2½"

Hirschmann

		∅	Länge, Length, Longueur, Largo
17-1208-04	Fig. 4	22 mm	13 cm/5"

17



Chelsea Eaton

		∅	Länge, Length, Longueur, Largo
17-1209-22	Fig. 1	22 mm	6,5 cm/2½"
17-1209-30	Fig. 2	30 mm	6,5 cm/2½"



Anoskop
 Anuscope
 Anuscope
 Anuscopio

Bensaude

		∅	Länge, Length, Longueur, Largo
17-1210-19	Fig. 1	19 mm	7,0 cm/2¾"
17-1210-22	Fig. 2	22 mm	7,0 cm/2¾"





Sphinkteroskope
Sphincteroscopes
Sphinctérosopes
Esfincteroscopios

Kelly		Ø	Länge, Length, Longueur, Largo
17-1211-21	Fig. 1	21 mm	x 5,0 cm/2"
17-1211-25	Fig. 2	25 mm	x 5,0 cm/2"

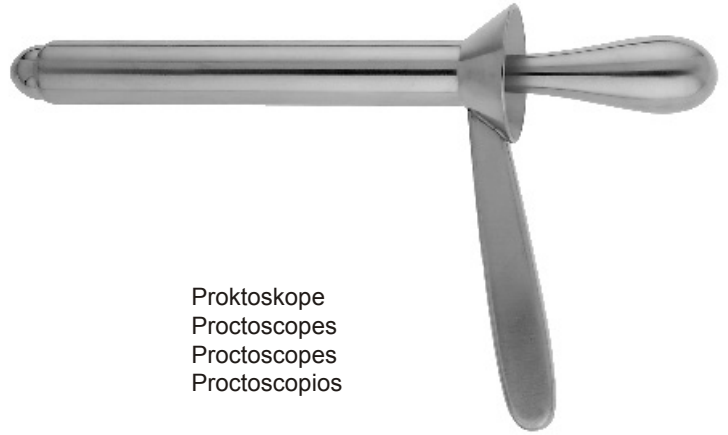

Proktoskope
Proctoscopes
Proctoscopes
Proctoscopios

Kelly		Ø	Länge, Length, Longueur, Largo
17-1212-01	Fig. 1	22 mm	x 5,0 cm/2"
17-1212-02	Fig. 2	22 mm	x 10,0 cm/4"
17-1212-03	Fig. 3	22 mm	x 14,5 cm/6"
17-1212-04	Fig. 4	22 mm	x 20,0 cm/8"

17



Anuskope
Anusopes
Anusopes
Anuscopios

Ives-Fansler		Ø	Länge, Length, Longueur, Largo
17-1213-22		22 mm	x 9,5 cm/4"

mit Kaltlichtanschluß
with cold light connection
avec connexion de lumière froide
con conexión de luz fría

Ives-Fansler		Ø	Länge, Length, Longueur, Largo
17-1214-22		22 mm	x 9,5 cm/4"



Analspreizer
17-1215-01
18,0 cm/7"
15/30 x 70 mm

17-1215-10
Kaltlichtaufsatz
Cold light attachment
Elément de lumière froide
Empalme de luz fría



Analspreizer
18,0 cm/7"
15/30 x 70 mm

17-1215-02
mit Kaltlichtaufsatz
with cold light attachment
avec élément de lumière
froide
con empalme de luz fría



70 x 22 mm

Mastdarm-Spekula
Rectal Specula
Spéculums rectaux
Espéculos rectales

Barr

17-1216-17
17,0 cm/6¾"

Analspreizer
Anal Retractors
Ecarteurs rectaux
Separadores rectales

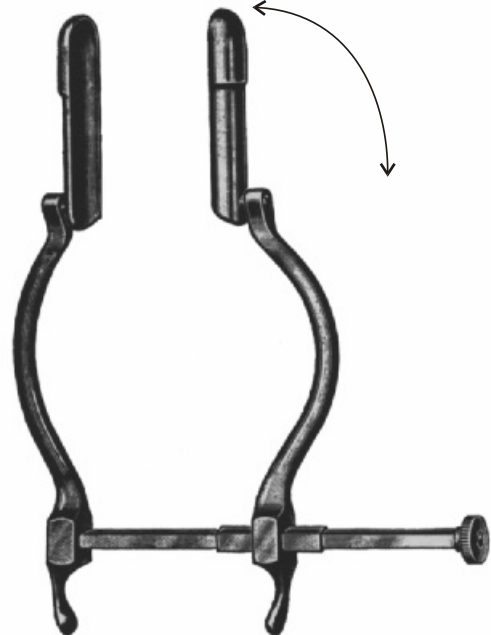

Smith-Buie

17-1218-15
15,0 cm/6"





Alan Parks

17-1220-00
13,5 cm/13¼"

bestehend aus:
consisting of:
composé de:
compuesto de:

17-1220-01
17-1220-02
17-1220-03 2x
17-1220-04 2x

17-1220-01
Sperrer, allein
Spreader, only
Ecarteur, seul
Separador, suelto

17-1220-02
Mittelblatt, allein
Center blade, only
Valve centrale, seule
Valva central, suelta
95 x 24 mm

17-1220-03
Blatt, allein
Blade, only
Valve, seule
Valva, suelta
75 x 24 mm

17-1220-04
Blatt, allein
Blade, only
Valve, seule
Valva, suelta
95 x 24 mm



Czerny

17-1223-22
22,0 cm/8³/₄"



**Sims
(Bodenhammer)**

17-1224-01
15,0 cm/6"

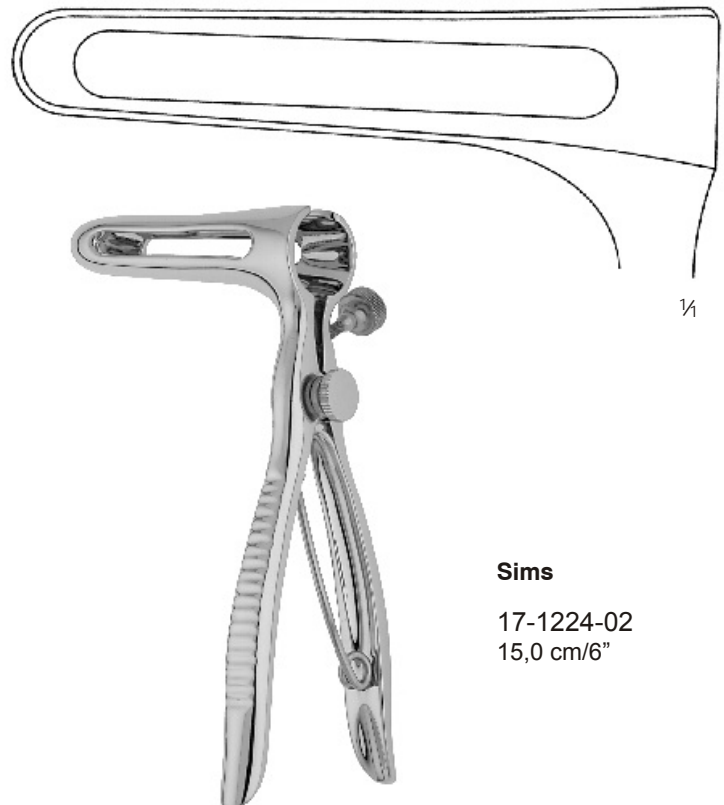

Sims

17-1224-02
15,0 cm/6"



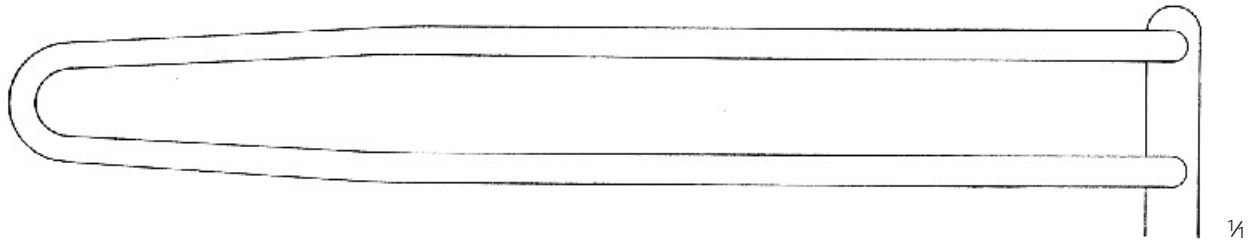

23 x 150 mm

17-1225-01

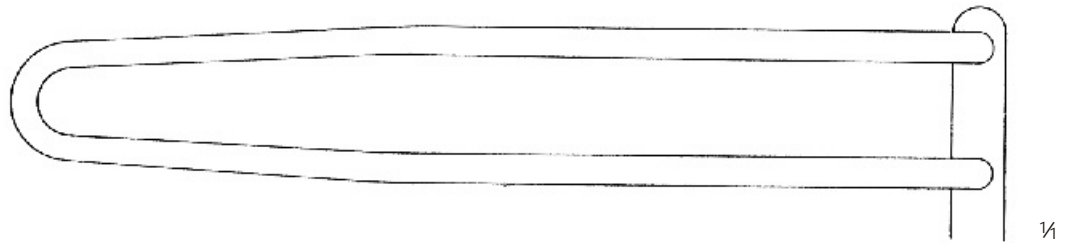

23 x 125 mm

17-1225-02



23 x 80 mm

17-1225-03

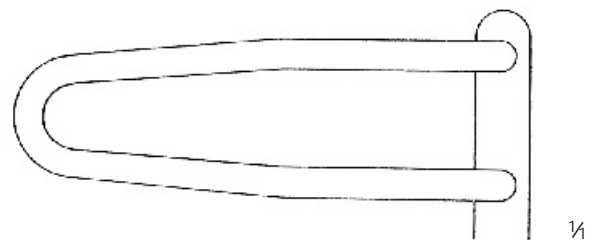

20 x 60 mm

17-1225-04



Sims

Gesamtlänge
Total length,
Longueur totale
Largo total

17-1225-01	24,0 cm/9½"
17-1225-02	24,0 cm/9½"
17-1225-03	24,0 cm/9½"
17-1225-04	17,0 cm/6¾"

Auf Anfrage auch mit Kaltlichtanschluß lieferbar. On request, also available with coldlight connection.
A demande aussi livrable avec connexion de lumière froide. A demanda se puede también suministrar con conexión de luz fría.

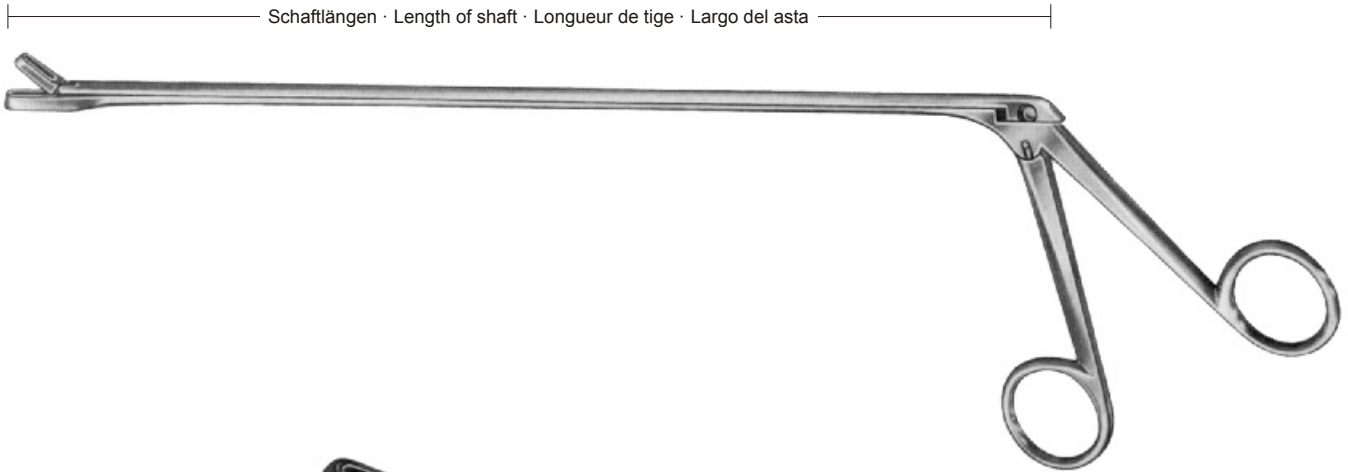
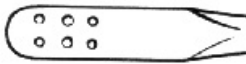
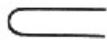

Fig. 1



3,5 x 14 mm

Yeoman

17-1230-28	28 cm/11"
17-1230-35	35 cm/13 ³ / ₄ "
17-1230-42	42 cm/16 ¹ / ₂ "

Fig. 2

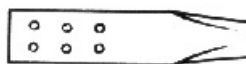
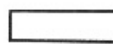

3,5 x 14 mm

Yeoman

17-1231-28	28 cm/11"
17-1231-35	35 cm/13 ³ / ₄ "
17-1231-42	42 cm/16 ¹ / ₂ "



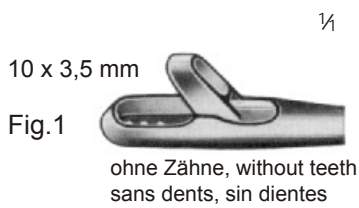
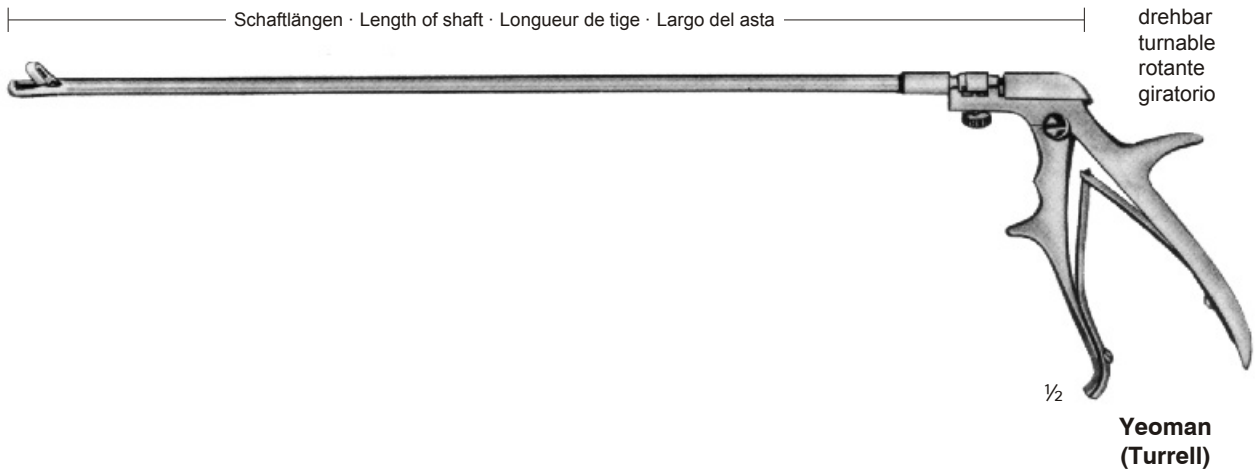

Zange komplett mit Griff Forceps complete with handle Pince complète avec manche Pinza completa con mango	Schaftlänge Length of shaft Longueur de tige Largo del asta	Aufsatz allein Attachment only Embout seul Punta suelta
17-1233-33	33 cm / 13"	17-1233-01
17-1233-40	40 cm / 16"	17-1233-02
17-1234-33	33 cm / 13"	17-1234-01
17-1234-40	40 cm / 16"	17-1234-02
17-1235-33	33 cm / 13"	17-1235-01
17-1235-40	40 cm / 16"	17-1235-02
17-1236-33	33 cm / 13"	17-1236-01
17-1236-40	40 cm / 16"	17-1236-02



Universal
17-1240-01



Yeoman
17-1240-02
Ringgriff
Ring Handle
Manche d'anneaux
Mango de anillo



Walton
17-1240-03



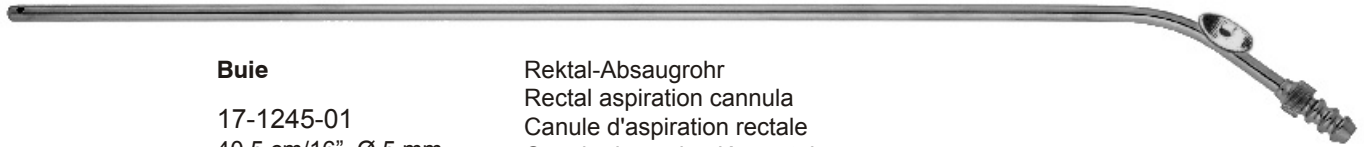

Buie
17-1245-01
40,5 cm/16", Ø 5 mm
Rektal-Absaugrohr
Rectal aspiration cannula
Canule d'aspiration rectale
Canula de aspiración rectal

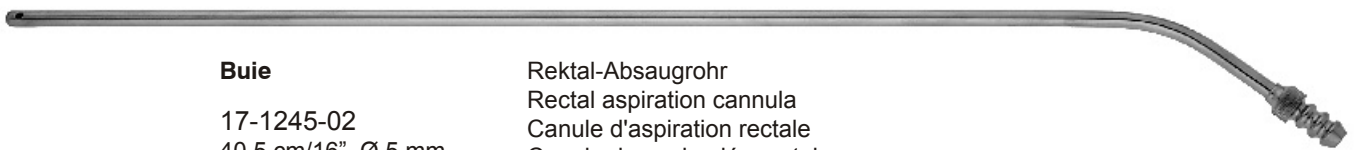

Buie
17-1245-02
40,5 cm/16", Ø 5 mm
Rektal-Absaugrohr
Rectal aspiration cannula
Canule d'aspiration rectale
Canula de aspiración rectal



Larry
17-1246-15
15,0 cm/6"
biegsam, malleable
malléable, maleable
Rektal-Sonde
Rectal director
Sonde rectale
Sonda rectal

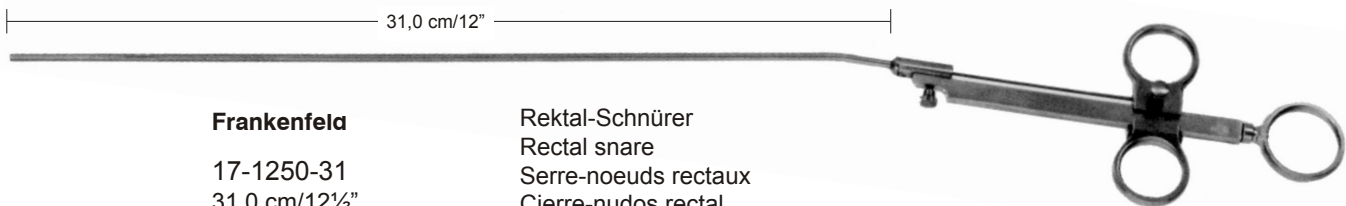

Frankenfeld
17-1250-31
31,0 cm/12½"
Rektal-Schnürer
Rectal snare
Serre-noeuds rectaux
Cierre-nudos rectal



17-1250-03 0,3 mmØ
Pack à 12 Stück
Pack of 12 pieces
Paquet à 12 pièces
Paquete con 12 piezas
Stahldraht für Rektalschnürer
Steel wire for rectal snares
Anses en fil d'acier pour serre- noeuds rectaux
Alambre de acero para cierre-nudos rectales



Frankfeldt

17-1251-36 36,0 cm/14½"

Dreiteiliges Maul
Jaw of three pieces
Mors à trois pièces
Boca de tres piezas



17-1252-28 28,0 cm/11¼"

17-1252-38 38,0 cm/15¼"

Zweiteiliges Maul
Jaw of two pieces
Mors à deux pièces
Boca de dos piezas



Eder

17-1253-28 28,0 cm/11¼"

17-1253-38 38,0 cm/15¼"

Dreiteiliges Maul
Jaw of three pieces
Mors à trois pièces
Boca de tres piezas



17-1260-00
Kaltlichtquelle
Coldlight source
Source de lumière froide
Fuente de luz fría
150 Watt/230 Volt



Kaltlichtkabel
Fibre optic cable
Cable de lumière froide
Cable de luz fría

Ø	Länge, Length Longueur, Largo	
	180 cm/72"	230 cm/92"
3,5 mm	17-1261-35	17-1262-35
4,5 mm	17-1261-45	17-1262-45
6,0 mm	17-1261-60	17-1262-60

Adapter für
Adapter for
Adapter pour
Adaptador para

Projektorseite, projector side, côte du projecteur, lado del proyector	
Volpi, Schölly, Loptec, RFQ	17-1265-01
Storz	17-1265-02
Henke Sass Wolf, Wolf, Richards	17-1265-03
Heine, ACM	17-1265-04
Winter, Ibe	17-1265-05
Olympus	17-1265-06
Schott, Zeiss	17-1265-07
Dyonics	17-1265-08

Instrumentenseite, instrument side, côte de l'instrument, lado del instrumento	
Storz, Winter, Ibe	17-1266-01
Henke Sass Wolf, Wolf, Richards	17-1266-02
ACM, Heine	17-1266-03
Stryker	17-1266-04
Schott, Zeiss	17-1266-05

Neurochirurgie und Laminektomie
Neurosurgery and Laminectomy
Neurochirurgie et Laminectomie
Neurocirugía y Laminectomía

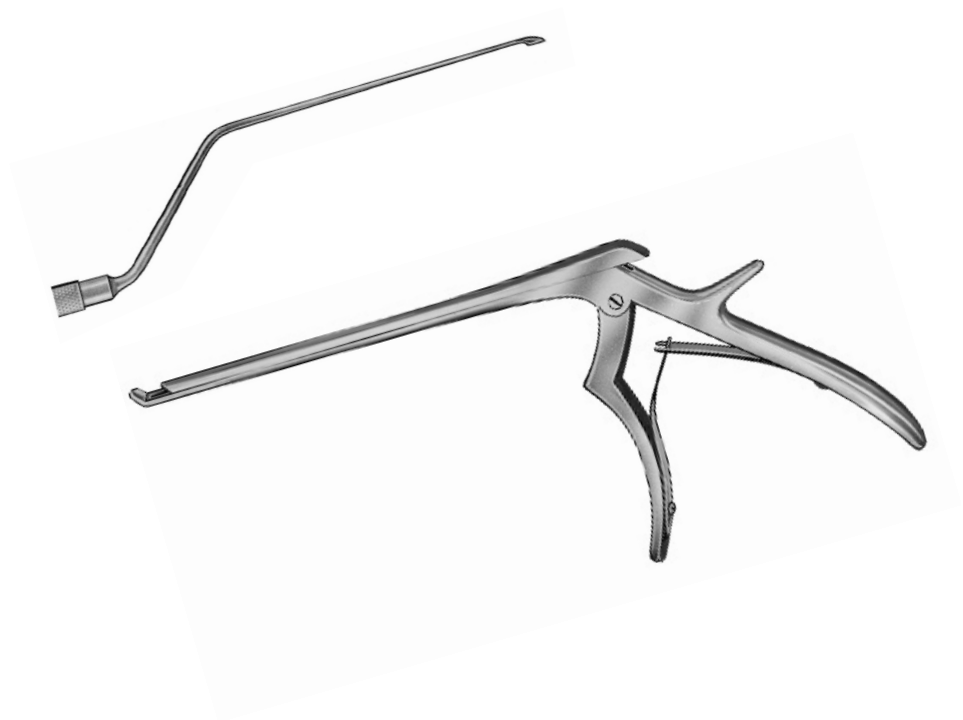

Drahtsäge
Wire Saw
Scie en fil
Sierra de hilo

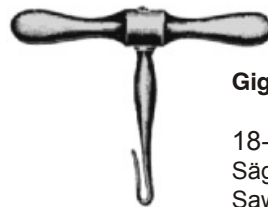
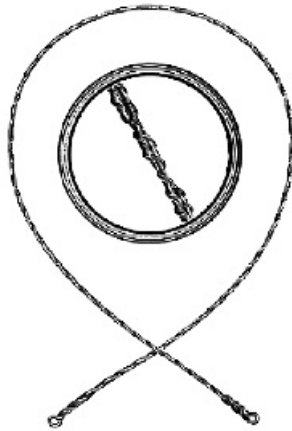

Gigli

18-1323-00
Sägegriff
Saw handle
Manche pour scies
Mango para sierras



Olivecrona

2-fach, two-fold, à deux pièces,
de dos piezas
1,2 mmØ

18-1320-30	Fig. 1	30 cm/12"
18-1320-40	Fig. 2	40 cm/16"
18-1320-50	Fig. 3	50 cm/20"
18-1320-60	Fig. 4	60 cm/24"
18-1320-70	Fig. 5	70 cm/28"

Gigli

3-fach, three-fold, à trois pièces,
de tres piezas
1,4 mmØ

18-1321-30	Fig. 1	30 cm/12"
18-1321-40	Fig. 2	40 cm/16"
18-1321-50	Fig. 3	50 cm/20"
1,8 mmØ		
18-1322-50	Fig. 1	50 cm/20"

Martel

Einführungsinstrument für Drahtsägen
Conductor for wire saws
Conducteur pour scies en fil
Conductores para sierras de hilo

18-1324-30	30,0 cm/12"
18-1324-33	33,0 cm/13¼"



Schädelzangen
Skull-Cutting Forceps
Pinces pour le crâne
Pinzas para el cráneo

Dahlgren

18-1328-20
20,0 cm/8"



De Vibiss

18-1329-21
21,0 cm/8¼"



18-1340-00

Schädelhalter für die Extension des Halswirbels, Dorne verstellbar, Vorbohren nicht erforderlich

Cervical Traction Tong, for extension of the neck vertebrae, pins adjustable hence no initial drilling

Pince de traction crânienne, pour l'extension des vertèbres cervicales, madrins réglables supprimant la perforation initiale

Pinca de tracción craneal para la extensión de las vertebras de cuello, puntas ajustables suprimiendo perforaciones iniciales

18-1340-01

Ersatzdorn, Spare pin only, Pointe de rechange seule, Punta de repuesto suelta



Crutchfield

Fig. 1

18-1341-01

Schädelhalter

Cervical Traction Tong

Pince de traction crânienne

Pinca de tracción craneal



Crutchfield

Fig. 2

18-1341-02

Schädelhalter

Cervical Traction Tong

Pince de traction crânienne

Pinca de tracción craneal

Ø 3,5 mm



Ø 5,0 mm



18-1341-04

3,5 mm

18-1341-05

5,0 mm

Vorbohrer für Crutchfield Schädelhalter

Drill Point for Crutchfield Cervical

Traction Tongs

Alésoir pour pinces de traction

crânienne de Crutchfield

Perforador inicial para pinzas de

tracción craneal de Crutchfield





Cloward
 18-1345-16
 16,0 cm/6½"

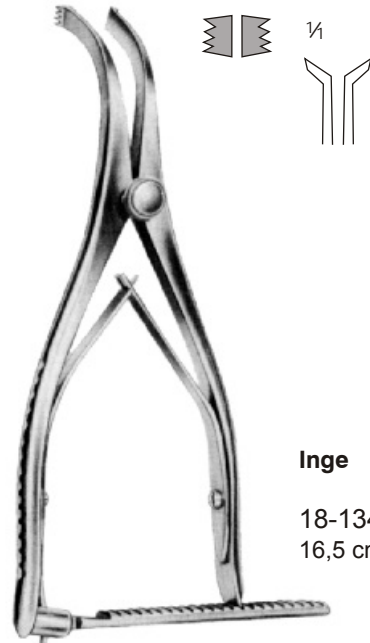

Inge
 18-1345-17
 16,5 cm/6½"

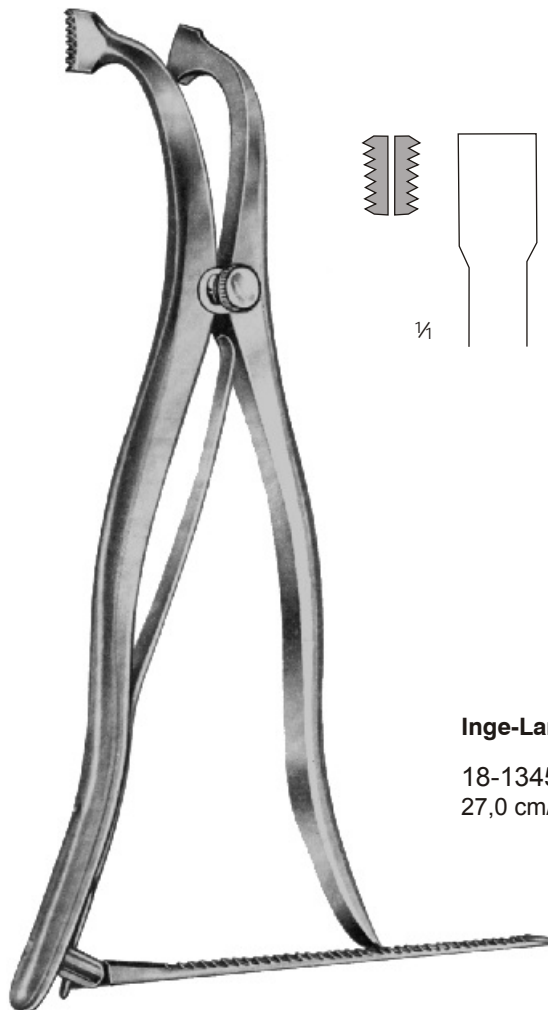

Inge-Lamina
 18-1345-27
 27,0 cm/10¾"

188

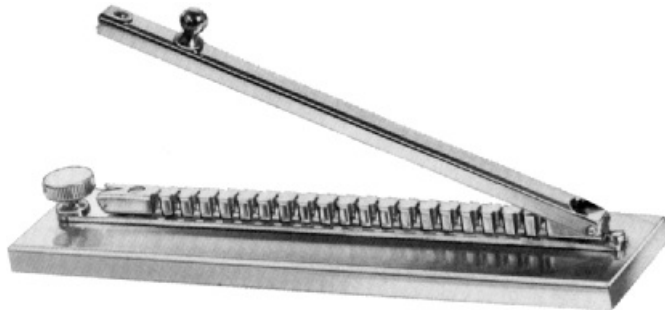

Mc Kenzie

18-1350-01
Klammernblock mit 1 Klammerbügel
Brain Clip Carrier, with 1 clip holding rack
Support porte-agrafes, avec 1 rangée d'agrafes
Porta-grapas, con 1 riel para grapas
148 x 40 x 6 mm / 5¾ x 1½ x ¼"



18-1351-00
100 Stück Silberklammern in Plastikbehälter
100 pieces Silver Brain Clips in plastic case
100 pièces agrafes en argent, dans une boîte de plastique
100 piezas grapas de plata en tubo de plástico

¼

18-1350-02
Klammernblock mit 2 Klammerbügeln und Schiebedeckeln
Brain Clip Carrier, with 2 clip holding rack and sliding covers
Support porte-agrafes, avec 2 rangée d'agrafes et couvercle à glissière
Porta-grapas, con 2 rieles para grapas y tapas corredizas
190 x 48 x 13 mm / 7½ x 2 x ½"



¼

Raney

18-1353-00
Kopfhautklammer
Scalp Hemostasis Clip
Clip hémostatique pour le cuir chevelu
Clip hemostática para el cuero cabelludo

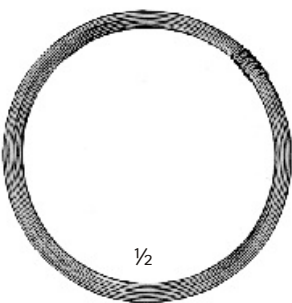

½

McKenzie

18-1352-00
Silberdraht in Ringen zu 2,5 Gramm
Silver Wire in coils of 2,5 g
Fil d'argent, par rouleaux de 2,5 g
Hilo de plata en rollos de 2,5 g



½

Raney

18-1354-00
16,0 cm/6½"
Anlege- und Abnehmezange für Kopfhaut-klammern
Applying and Removing Forceps for Scalp Hemostasis Clips
Pince pour appliquer et enlever les clips hémostatiques pour le cuir chevelu
Pinza para aplicar y quitar clips hemostáticas para el cuero cabelludo

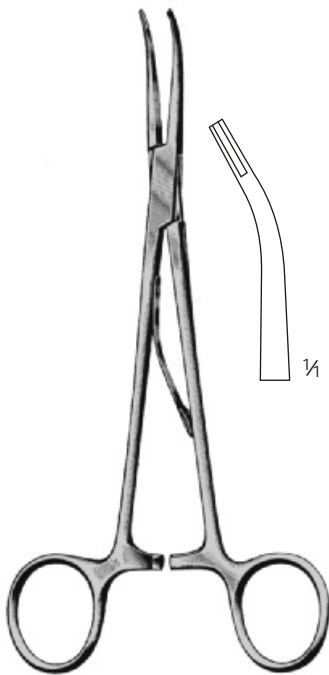

Klammer-Anlegezangen,
gebogen
Clip Applying Forceps,
curved
Pinces pour appliquer des
agrafes, courbes
Pinzas para poner grapas,
curvas

McKenzie

18-1360-15 15,0 cm/6"
 18-1360-19 19,0 cm/7½"

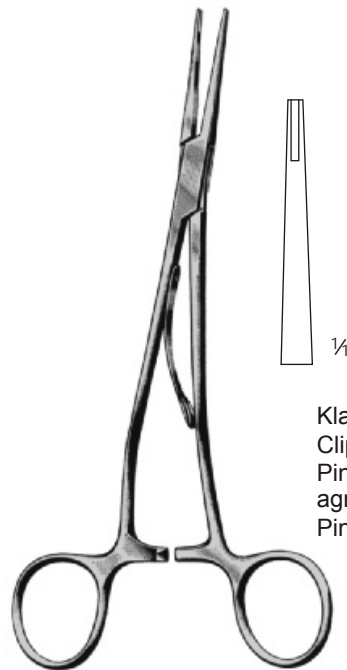

Klammer-Anlegezangen, gerade
Clip Applying Forceps, straight
Pinces pour appliquer des
agrafes, droits
Pinzas para poner grapas, rectas

McKenzie

18-1361-15 15,0 cm/6"
 18-1361-19 19,0 cm/7½"

— Schaftlänge · Length of shaft · Longueur de tige · Largo del asta —
 14,0 cm/5½"

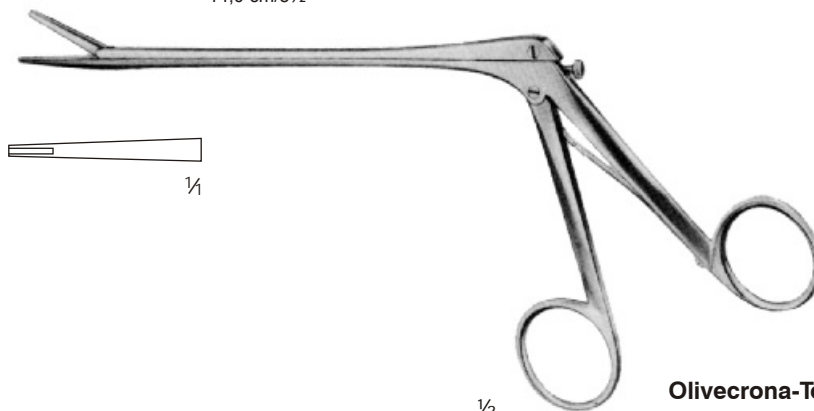

Olivecrona-Toennis

18-1362-14
 14,0 cm/5½"

Klammer-Anlegezange
 Clip Applying Forceps
 Pince pour appliquer des agrafes
 Pinza para poner grapa



Cushing
18,0 cm/7"

	mm
18-1364-01	7/ 9
18-1364-02	11/13
18-1364-03	15/18
18-1364-04	18/22



Heifetz
biegsam, malleable
malléable, maleable
20,0 cm/8"

	mm
18-1365-08	8
18-1365-11	11
18-1365-14	14
18-1365-17	17
18-1365-20	20

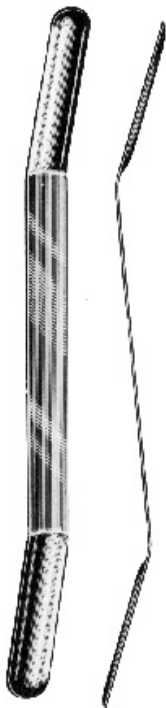

Olivecrona
18,0 cm/7"

Spatelbreite, mm
Width of spatulas, mm
Largeur de spatule, mm
Anchura de espátulas, mm

	oben upper end en haut arriba	unten lower end en bas abajo	
18-1366-01	7	9	18-1367-01
18-1366-02	11	13	18-1367-02
18-1366-03	15	18	18-1367-03
18-1366-04	18	22	18-1367-04

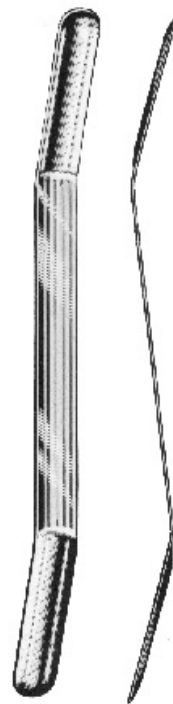



Fig. 1
18-1369-01



Fig. 2
18-1369-02



Fig. 3
18-1369-03



Fig. 4
18-1369-04

Caspar
24,5 cm/9¾"

geknöpft, isoliert
 probe-end, insulated
 boutonné, isolé
 abotonado, aislado

¼



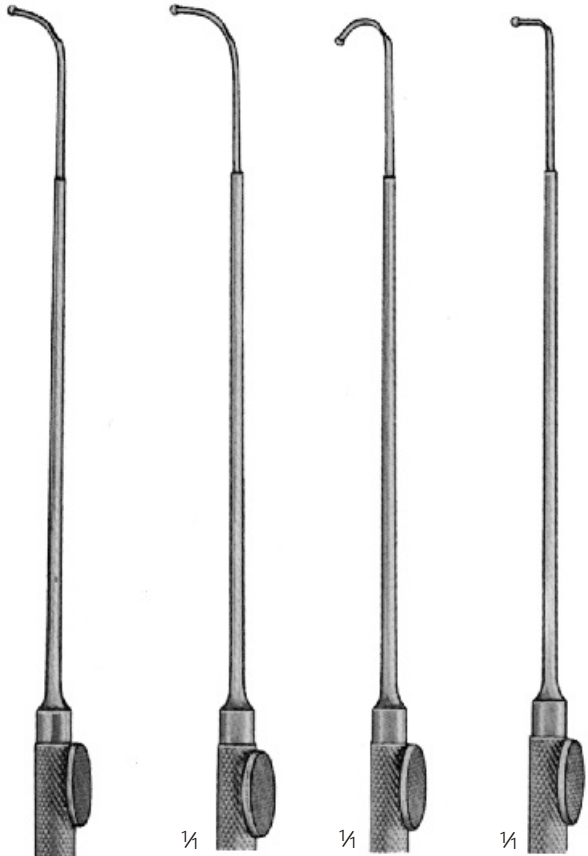

Fig. 2
18-1370-02

Fig. 3
18-1370-03

Fig. 4
18-1370-04

Yasargil

Fig. 1
18-1370-01
18,5 cm/7¼"
Fadenführer, geknöpft
Ligature Guide, probe pointed
Passe-fil, boutonné
Guía-ligadura, abotonado

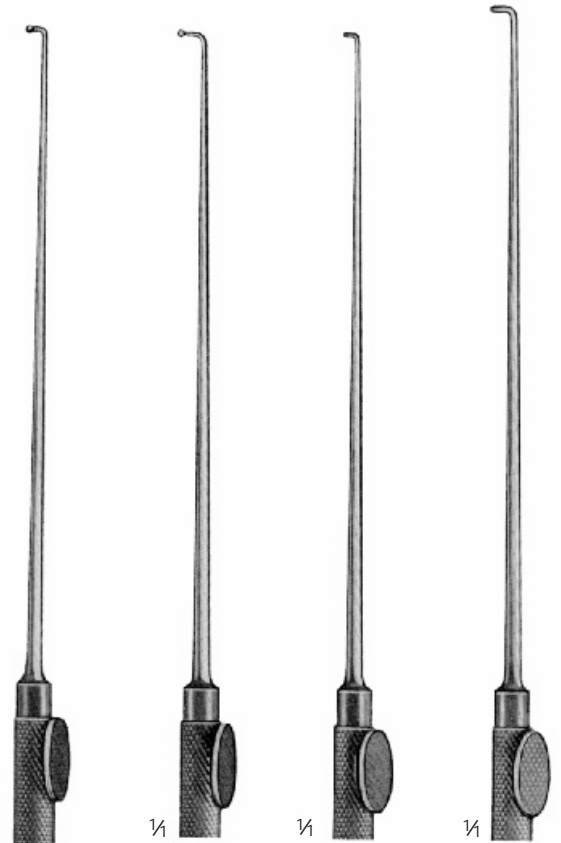

Fig. 2
18-1371-02

Fig. 3
18-1371-03

Fig. 4
18-1371-04

Krayenbühl

Fig. 1
18-1371-01
18,5 cm/7¼"
Nerv- und Gefäßhäkchen
Nerve- and Vessel Hooks
Crochets à nerfs et à vaisseaux
Ganchos para nervios y vasos





18-1372-19
18,5 cm/7¼"

Durahäkchen
Dura Hook
Crochet pour la dure-mère
Ganchito para dura-madre



Fisch

18-1373-19
18,5 cm/7¼"

Feines Häkchen
Delicate Hook
Crochet fin
Ganchito muy fino



Yasargil
18,5 cm/7¼"

Mikro-Raspator
Micro-raspatory
Micro-rugine
Micro-periostótomo



Fig. 1
18-1374-01

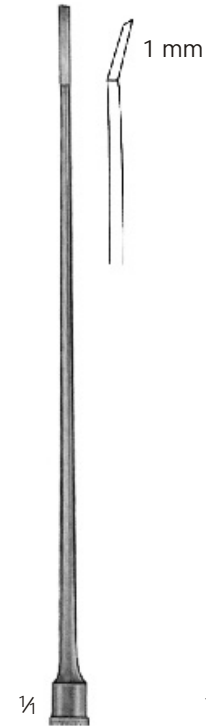

Fig. 2
18-1374-02

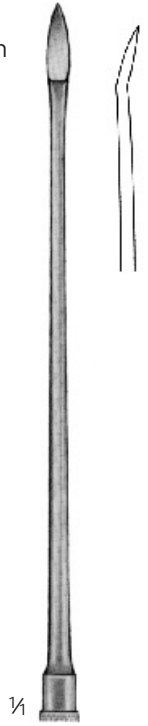

Fig. 3
18-1374-03

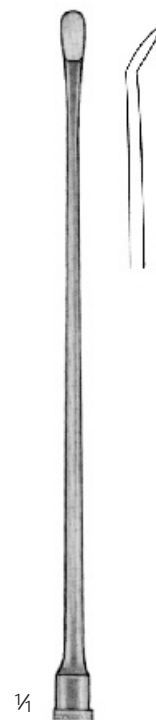

Fig. 4
18-1374-04

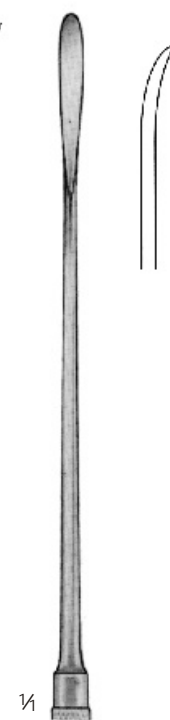

Fig. 5
18-1374-05

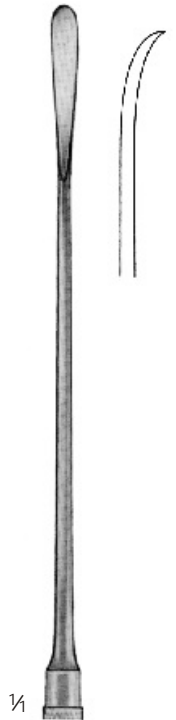
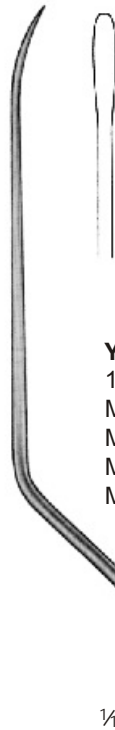

Fig. 6
18-1374-06



Yasargil
 18,5 cm/7¼"
 Fadengabel
 Suture pusher
 Fourche à fil
 Empujador de sutura

Fig. 1
 18-1375-01



Yasargil
 18,5 cm/7¼"
 Mikro-Raspatorien
 Micro-raspatories
 Micro-rugines
 Micro-periostótomos

Fig. 2
 18-1375-02

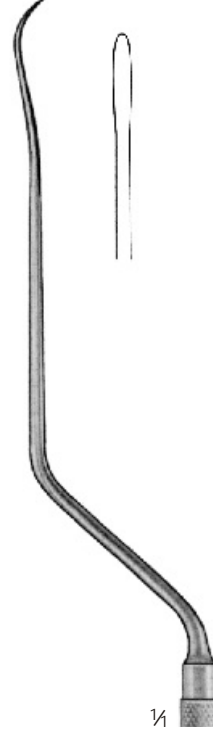

Fig. 3
 18-1375-03

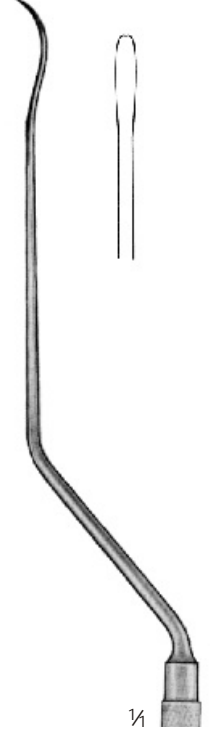

Fig. 4
 18-1375-04



Yasargil
 18,5 cm/7¼"
 Scharfer Löffel
 Scoop, bayonet-shaped
 Curette tranchante
 Cucharilla cortante

18-1376-19



Jakobson
 18,5 cm/7¼"
 Doppelsonde
 Twin Probe
 Sonde double
 Sonda doble

18-1377-19



Jacobson
 18,5 cm/7¼"
 Knopfsonde
 Buttoned Probe
 Sonde boutonée
 Sonda abotonada

18-1378-19





1/4

Jacobson
18-1379-19
18,5 cm/7 1/4"

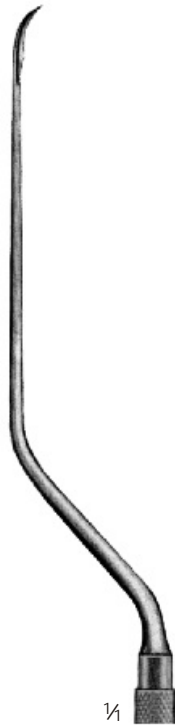

1/4

Koos
Fig. 1
18-1380-01
18,5 cm/7 1/4"



1/4

Koos
Fig. 2
18-1380-02
18,5 cm/7 1/4"



1/4

Koos
Fig. 3
18-1380-03
18,5 cm/7 1/4"

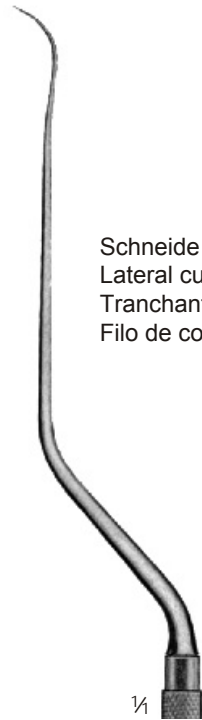

1/4

Kraus
18-1381-19
18,5 cm/7 1/4"

Schneide seitlich
Lateral cutting edge
Tranchant latéral
Filo de corte lateral

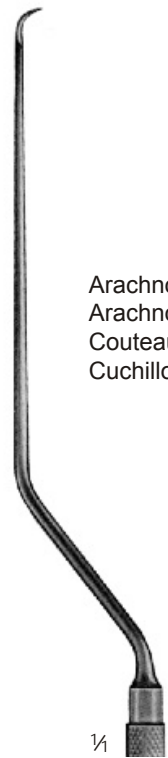

1/4

Yasargil
18-1382-19
18,5 cm/7 1/4"

Arachnoidea-Messer
Arachnoid Knife
Couteau à arachnoïdes
Cuchillo para arachnoide



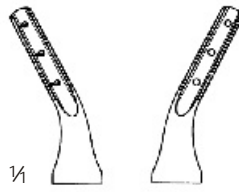

Ø 7 mm

Yasargil

18-1395-01
31,0 cm/12¼"



Ø 9 mm

Yasargil

18-1395-02
41,0 cm/16"



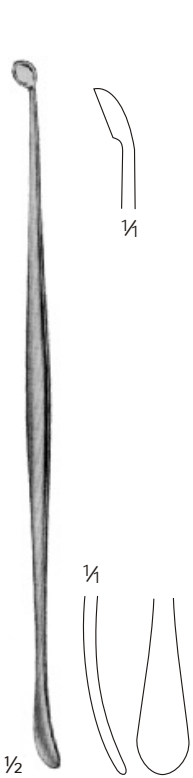

Penfield

Fig. 1
18-1401-01
18,0 cm/7"

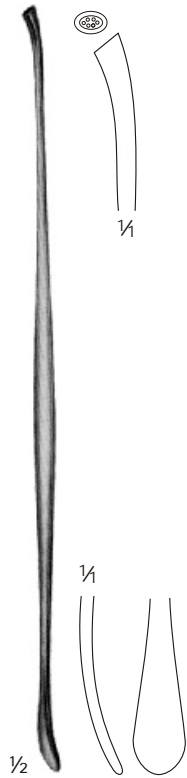

Penfield

Fig. 2
18-1401-02
20,0 cm/8"

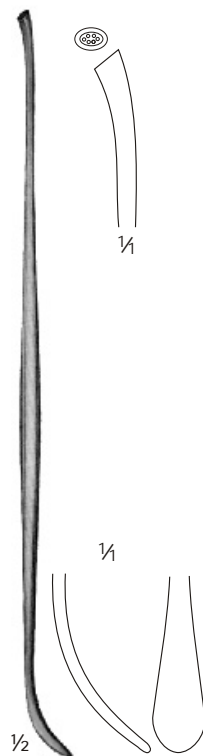

Penfield

Fig. 3
18-1401-03
20,0 cm/8"



Penfield

Fig. 4
18-1401-04
21,5 cm/8½"



Penfield

Fig. 5
18-1401-05
29,0 cm/11½"

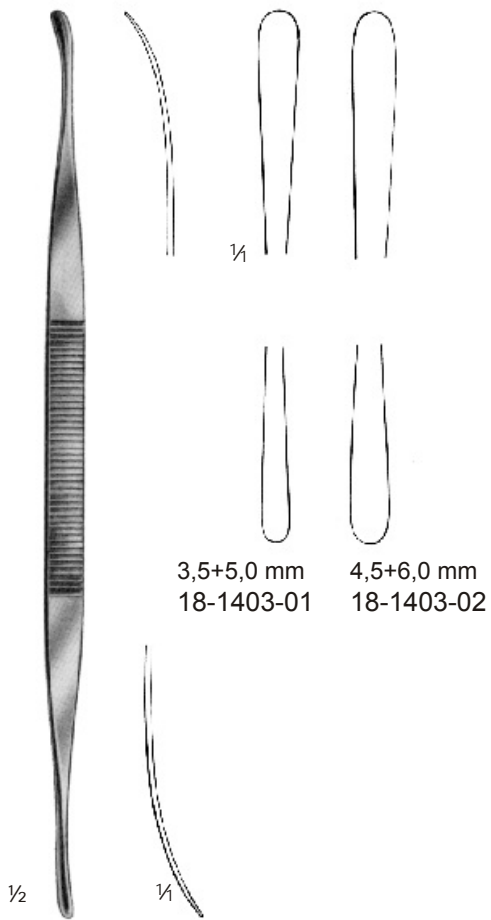

Toennis
 24,0 cm/9½"

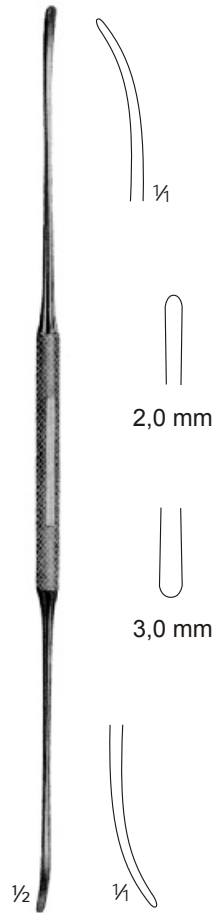

Olivecrona
 2 + 3 mm
 18-1404-01 18,0 cm/7"
 18-1404-02 24,0 cm/9½"

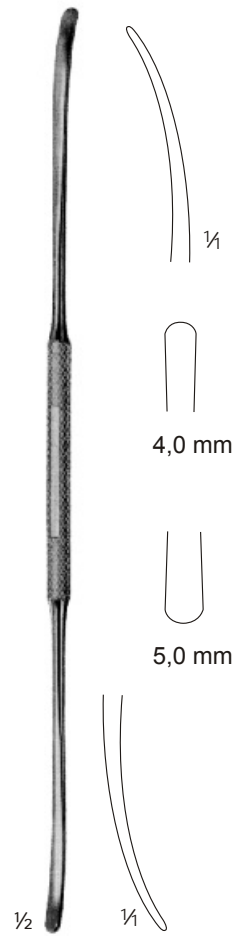

Olivecrona
 4 + 5 mm
 18-1404-03 18,0 cm/7"
 18-1404-04 24,0 cm/9½"



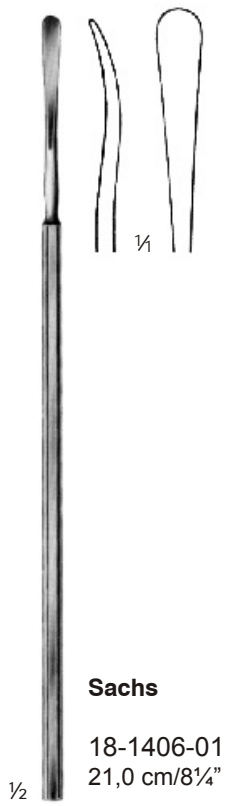

Sachs

18-1406-01
21,0 cm/8 1/4"



Sachs

18-1406-02
21,0 cm/8 1/4"

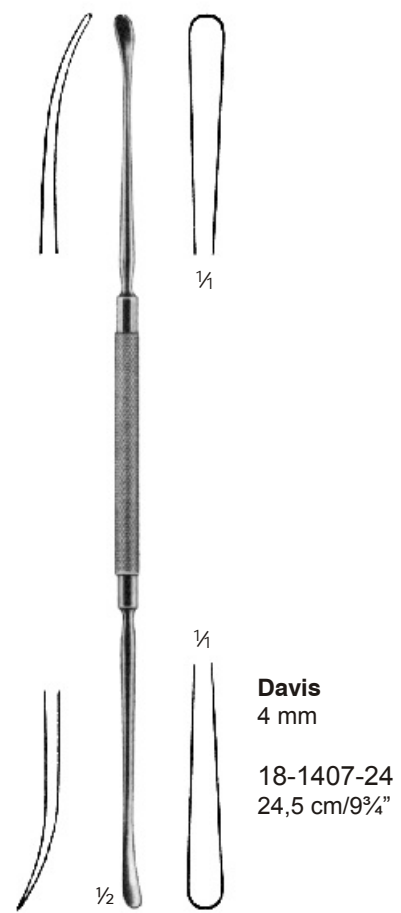

Davis
4 mm

18-1407-24
24,5 cm/9 3/4"

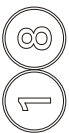

Frazier

18-1410-01
15,0 cm/6"



Hoen

18-1410-02
15,0 cm/6"

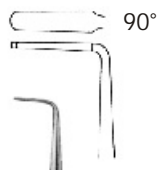

Hoen

18-1410-03
15,0 cm/6"

Dura-Separatoren
Dura Dissectors
Dissecteurs pour la dure-mère
Descoladores de dura-madre

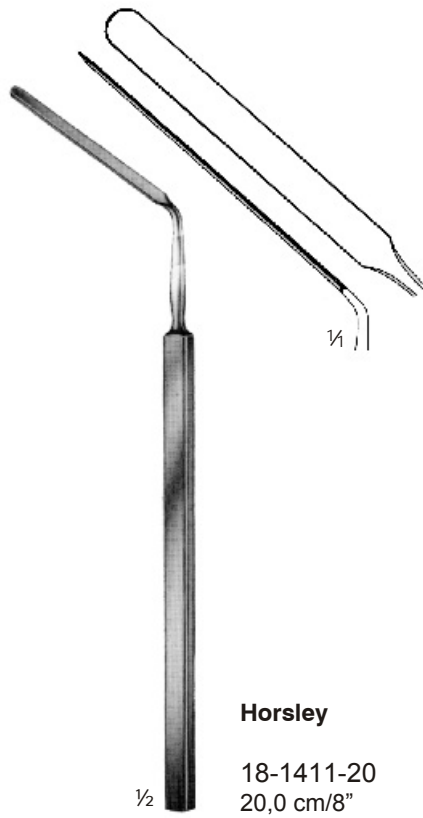

Dura Separator
 Dura Dissector
 Dissecteur pour la dure-mère
 Descolador de dura-madre

Horsley

18-1411-20
 20,0 cm/8"

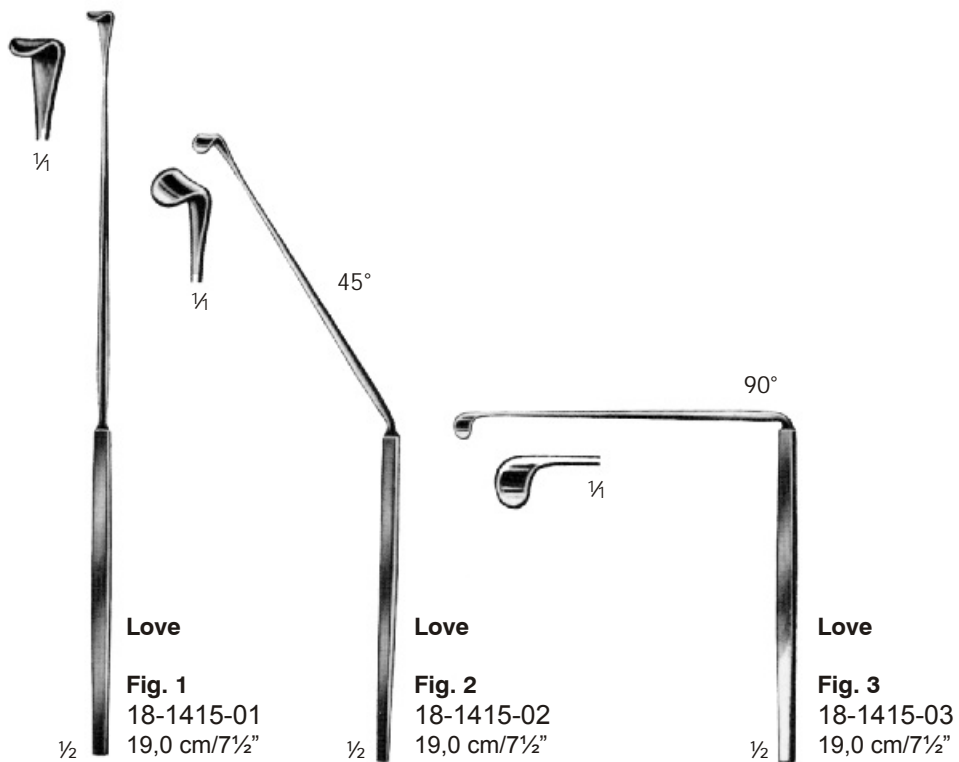

Love

Fig. 1
 18-1415-01
 19,0 cm/7½"

Love

Fig. 2
 18-1415-02
 19,0 cm/7½"

Love

Fig. 3
 18-1415-03
 19,0 cm/7½"



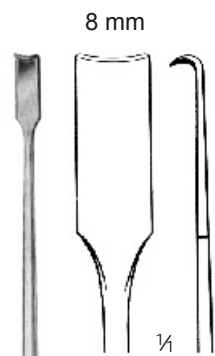

1/2

Scoville

18-1416-01
 23,0 cm/9"
 gerade, straight
 droit, recto

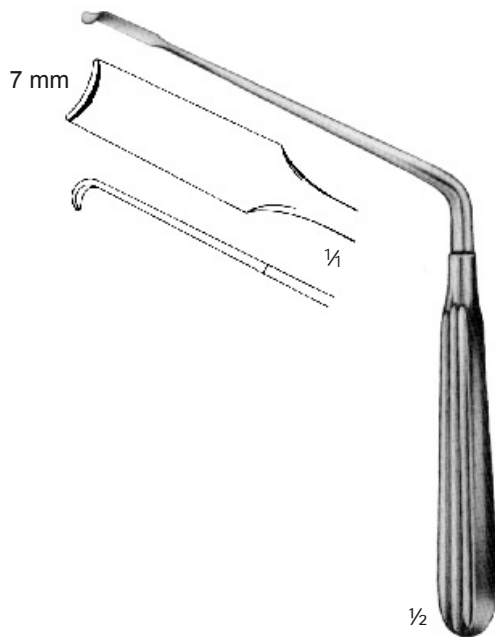

1/2

Scoville

18-1416-02
 20,0 cm/8"
 abgewinkelt, angular
 coudé, angular

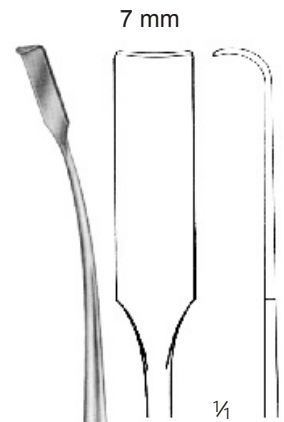

1/2

Holsher

18-1417-24
 24,0 cm/9 1/2"

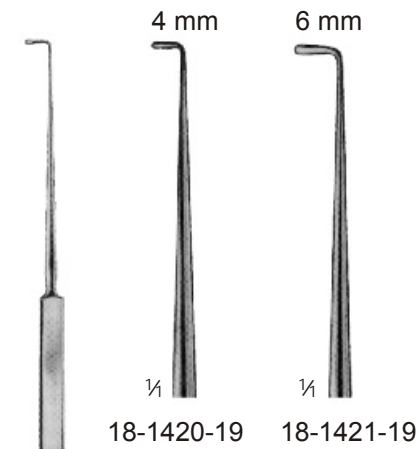

Cushing

18-1420-19 19,0 cm/7½"
 18-1421-19 19,0 cm/7½"

½

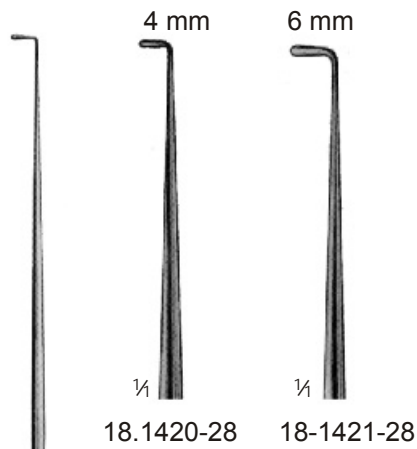

Cushing

18-1420-28 28,0 cm/11"
 18-1421-28 28,0 cm/11"

½



Dandy

18-1422-20
 20,0 cm/8"

½

Crile

18-1424-20
 20,0 cm/8"

½

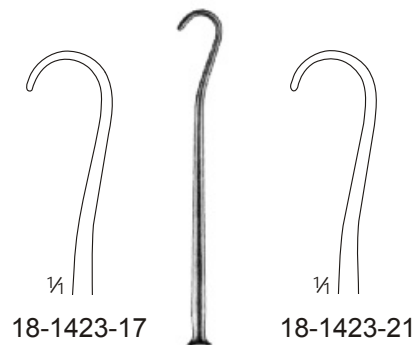

Smithwick

18-1423-17 17,0 cm/6½"
 18-1423-21 21,0 cm/8¼"

½





Adson
spitz, sharp
pointu, agudo

18-1425-01
20,0 cm/8"



Adson
stumpf, blunt
mousse, romo

18-1425-02
20,0 cm/8"



Frazier
spitz, sharp
pointu, agudo

18-1426-13 13,0 cm/5"
18-1426-18 18,0 cm/7"

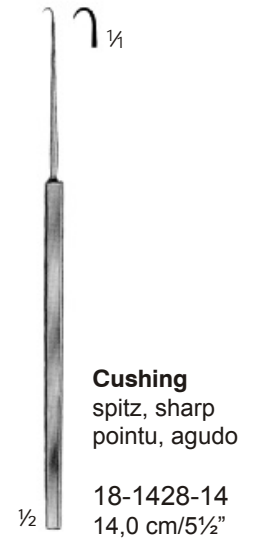

Cushing
spitz, sharp
pointu, agudo

18-1428-14
14,0 cm/5½"

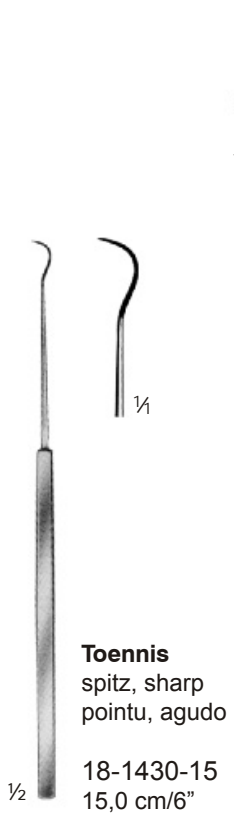

Toennis
spitz, sharp
pointu, agudo

18-1430-15
15,0 cm/6"

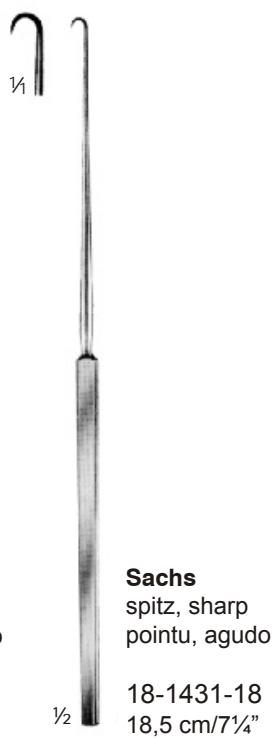

Sachs
spitz, sharp
pointu, agudo

18-1431-18
18,5 cm/7¼"



Graham
stumpf, blunt
mousse, romo

18-1432-16
16,5 cm/6½"

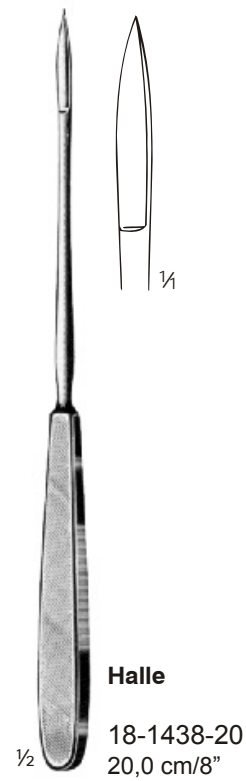

Halle

18-1438-20
20,0 cm/8"

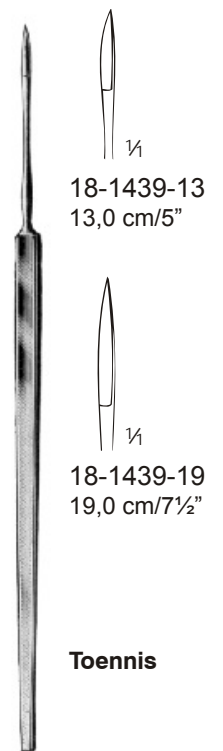

Toennis

18-1439-13
13,0 cm/5"

18-1439-19
19,0 cm/7½"

15,0 cm/6"



gerade, straight,
droite, recta

¼

18-1440-01 6 x 10 mm



nach oben abgewinkelt, angular upwards
angulée vers le haut, angular hacia arriba

¼

18-1440-02 6 x 10 mm



nach unten abgewinkelt, angular downwards
angulée vers le bas, angular hacia abajo

¼

18-1440-03 6 x 10 mm

Cloward

15,0 cm/6"



18-1441-02 2 x 10 mm



18-1441-03 3 x 10 mm



18-1441-04 4 x 10 mm

¼

Schlesinger



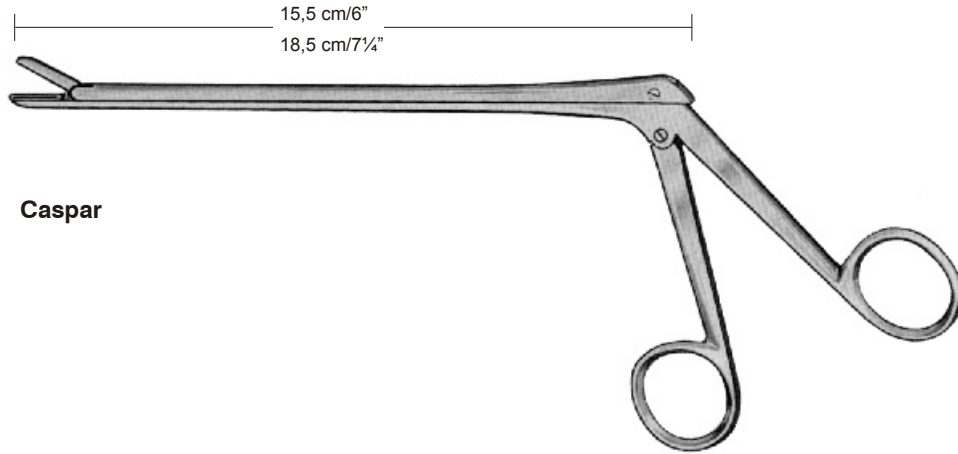

Caspar

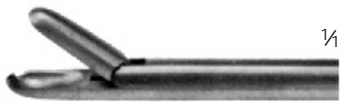

	2 x 12 mm	3 x 12 mm	4 x 14 mm
15,5 cm/6"	18-1442-02	18-1442-03	18-1442-04
18,5 cm/7¼"	18-1443-02	18-1443-03	18-1443-04



	2 x 12 mm	3 x 12 mm	4 x 14 mm
15,5 cm/6"	18-1444-02	18-1444-03	18-1444-04
18,5 cm/7¼"	18-1445-02	18-1445-03	18-1445-04



	2 x 12 mm	3 x 12 mm	4 x 14 mm
15,5 cm/6"	18-1446-02	18-1446-03	18-1446-04
18,5 cm/7¼"	18-1447-02	18-1447-03	18-1447-04

20,0 cm/8"

5,5 mm

Laminektomie-Zange
Laminectomy Rongeur
Pince emporte-pièce à laminectomie
Pinza cortante para laminectomia

Wagner

18-1447-20
27,0 cm/11"

18,0 cm/7"

Ø 7 mm

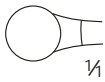

Oldberg

18-1448-18
25,0 cm/10"

18,5 cm/7 1/4"

Ø 3,5 mm



Yasargil

18-1449-18
25,5 cm/10 1/4"

Scharfe Hypophysenzange
Pituitary Rongeur, cutting
Pince pour hypophyse, tranchante
Pinza para hipófisis, cortante



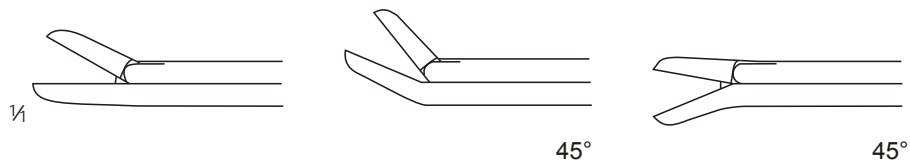
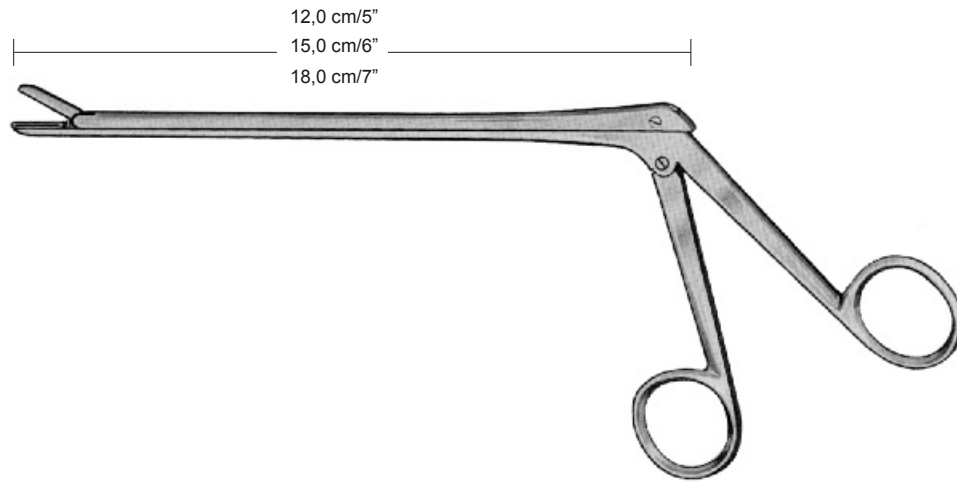

Cushing
2 x 10mm

12,0 cm/5"	18-1450-12	18-1451-12	18-1452-12
15,0 cm/6"	18-1450-15	18-1451-15	18-1452-15
18,0 cm/7"	18-1450-18	18-1451-18	18-1452-18

Love-Gruenwald
3 x 10mm

12,0 cm/5"	18-1460-12	18-1461-12	18-1462-12
15,0 cm/6"	18-1460-15	18-1461-15	18-1462-15
18,0 cm/7"	18-1460-18	18-1461-18	18-1462-18

Spurling
4 x 10mm

12,0 cm/5"	18-1470-12	18-1471-12	18-1472-12
15,0 cm/6"	18-1470-15	18-1471-15	18-1472-15
18,0 cm/7"	18-1470-18	18-1471-18	18-1472-18



Ferris-Smith-Kerrison

reguläres Modell
regular pattern
modèle regulier
modelo regular

zerlegbares Model
dismantable pattern
modèle démontable
modelo desmontable

		Bißbreite Width of bite Grandeur de coupe Ancho de la boca	Schaftlänge , Length of shaft Longueur de tige, Largo del asta		Schaftlänge , Length of shaft Longueur de tige, Largo del asta	
			18,0 cm/7"	20,0 cm/8"	18,0 cm/7"	20,0 cm/8"
90° nach oben schneidend 90° upwards cutting coupante vers le haut 90° cortante hacia arriba 90°	$\frac{1}{4}$ □	1 mm	18-1480-01	18-1481-01	18-1486-01	18-1487-01
	□	2 mm	18-1480-02	18-1481-02	18-1486-02	18-1487-02
	◐	3 mm	18-1480-03	18-1481-03	18-1486-03	18-1487-03
	◑	4 mm	18-1480-04	18-1481-04	18-1486-04	18-1487-04
	◒	5 mm	18-1480-05	18-1481-05	18-1486-05	18-1487-05
	◓	6 mm	18-1480-06	18-1481-06	18-1486-06	18-1487-06

		Bißbreite Width of bite Grandeur de coupe Ancho de la boca	Schaftlänge , Length of shaft Longueur de tige, Largo del asta		Schaftlänge , Length of shaft Longueur de tige, Largo del asta	
			18,0 cm/7"	20,0 cm/8"	18,0 cm/7"	20,0 cm/8"
40° nach oben schneidend 40° upwards cutting coupante vers le haut 40° cortante hacia arriba 40°	$\frac{1}{4}$ □	1 mm	18-1482-0	18-1483-01	18-1488-01	18-1489-01
	□	2 mm	18-1482-02	18-1483-02	18-1488-02	18-1489-02
	◐	3 mm	18-1482-03	18-1483-03	18-1488-03	18-1489-03
	◑	4 mm	18-1482-04	18-1483-04	18-1488-04	18-1489-04
	◒	5 mm	18-1482-05	18-1483-05	18-1488-05	18-1489-05
	◓	6 mm	18-1482-06	18-1483-06	18-1488-06	18-1489-06



Ferris-Smith-Kerrison

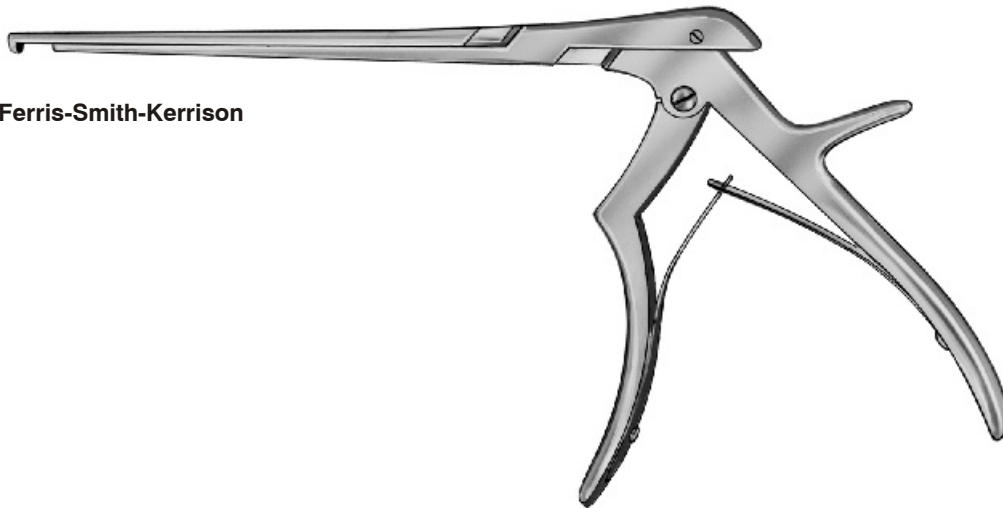

90° nach unten schneidend
90° downwards cutting
coupante vers le bas 90°
cortante hacia abajo 90°

Bißbreite
Width of bite
Grandeur de coupe
Ancho de la boca

Schaftlänge , Length of shaft
Longueur de tige, Largo del asta

		18,0 cm/7"		20,0 cm/8"	
1/4		1 mm	18-1484-01	18-1485-01	
		2 mm	18-1484-02	18-1485-02	
		3 mm	18-1484-03	18-1485-03	
		4 mm	18-1484-04	18-1485-04	
		5 mm	18-1484-05	18-1485-05	
		6 mm	18-1484-06	18-1485-06	

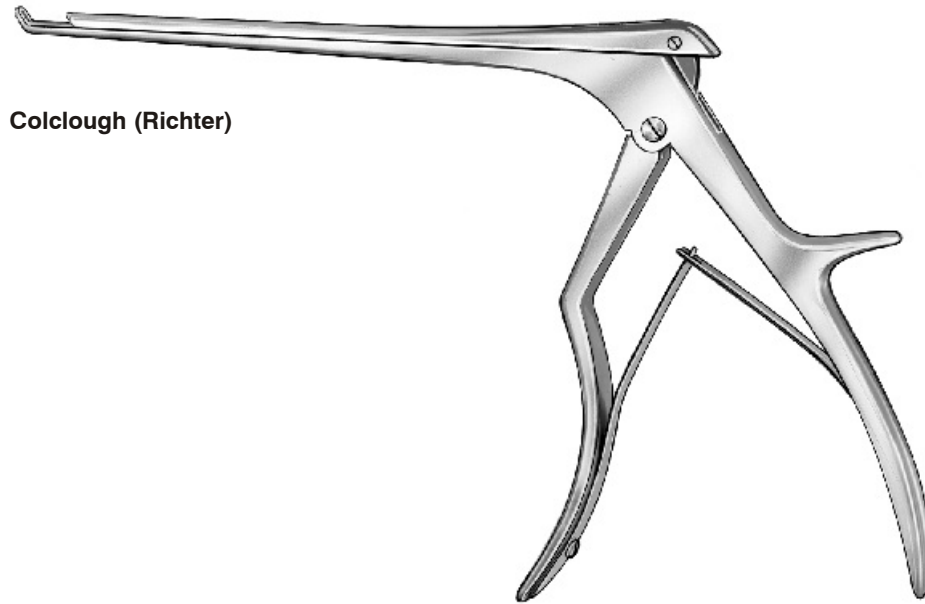





Colclough (Richter)

		Bißbreite Width of bite Grandeur de coupe Ancho de la boca	Schaftlänge , Length of shaft Longueur de tige, Largo del asta		
			15,0 cm/6"	18,0 cm/7"	20,0 cm/8"
90° nach oben schneidend 90° upwards cutting coupante ver le haut 90° cortante hacia arriba 90°					
$\frac{1}{4}$ □		2 mm	18-1502-15	18-1502-18	18-1502-20
□		3 mm	18-1503-15	18-1503-18	18-1503-20
□		4 mm	18-1504-15	18-1504-18	18-1504-20
□		5 mm	18-1505-15	18-1505-18	18-1505-20
□		6 mm	18-1506-15	18-1506-18	18-1506-20

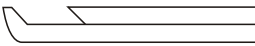
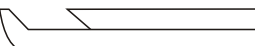
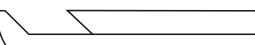

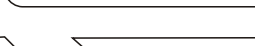
Colclough (Richter)

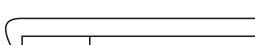
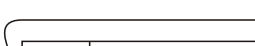
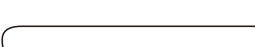
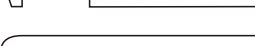
40° nach oben schneidend 40° upwards cutting coupante vers le haut 40° cortante hacia arriba 40°		Bißbreite Width of bite Grandeur de coupe Ancho de la boca	Schaftlänge , Length of shaft Longueur de tige, Largo del asta		
			15,0 cm/6"	18,0 cm/7"	20,0 cm/8"
¼ □		2 mm	18-1512-15	18-1512-18	18-1512-20
□		3 mm	18-1513-15	18-1513-18	18-1513-20
□		4 mm	18-1514-15	18-1514-18	18-1514-20
□		5 mm	18-1515-15	18-1515-18	18-1515-20
□		6 mm	18-1516-15	18-1516-18	18-1516-20

90° nach unten schneidend 90° downwards cutting coupante vers le bas 90° cortante hacia abajo 90°		Bißbreite Width of bite Grandeur de coupe Ancho de la boca	Schaftlänge , Length of shaft Longueur de tige, Largo del asta		
			15,0 cm/6"	18,0 cm/7"	20,0 cm 8"
¼ □		2 mm	18-1522-15	18-1522-18	18-1522-20
□		3 mm	18-1523-15	18-1523-18	18-1523-20
□		4 mm	18-1524-15	18-1524-18	18-1524-20
□		5 mm	18-1525-15	18-1525-18	18-1525-20
□		6 mm	18-1526-15	18-1526-18	18-1526-20

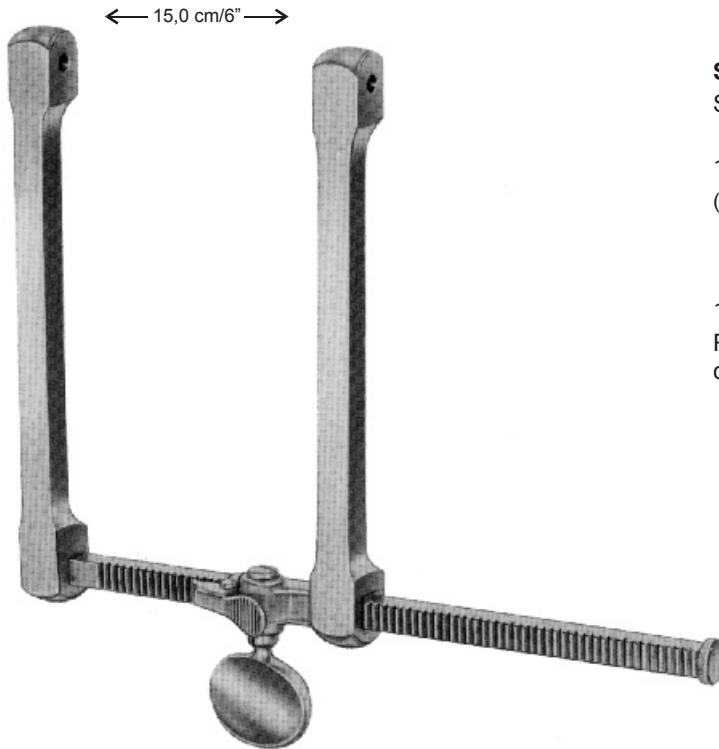

Scoville

Set, set, série, juego

18-1540-00

(1 x 18-1540-01, 1 x 18-1543-50, 1 x 18-1545-01)

18-1540-01

Rahmen allein, frame only,
cadre seul, cuadro solo

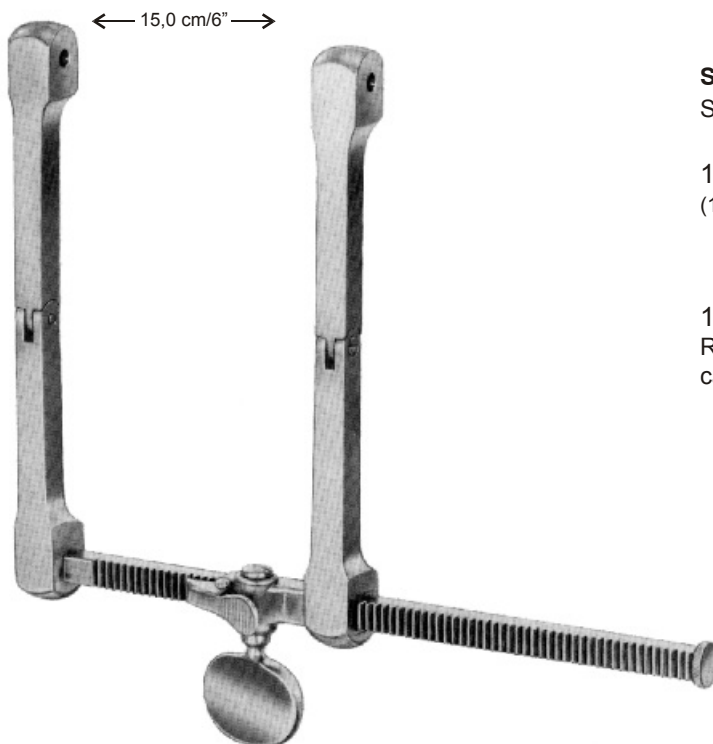

Scoville-Haverfield

Set, set, série, juego

18-1541-00

(1 x 18-1541-01, 1 x 18-1543-50, 1 x 18-1545-01)

18-1541-01

Rahmen allein, frame only,
cadre seul, cuadro solo



Haken, Hooks, Crochets, Separadores



Scoville
stumpf, blunt
mousse, romo

18-1543-50 50 mm/2"
18-1543-70 70 mm/2¾"
18-1543-75 75 mm/3"



Scoville
spitz, sharp
pointu, agudo

18-1544-50 50 mm/2"
18-1544-70 70 mm/2¾"
18-1544-75 75 mm/3"

Valven, Blades, Valves, Valvas



Scoville

18-1545-01 64 x 25 mm
18-1545-02 64 x 29 mm
18-1545-03 64 x 50 mm
18-1545-04 88 x 25 mm



Taylor

18-1546-01 38 x 44 mm



Taylor

18-1547-01 48 x 50 mm
18-1547-02 64 x 50 mm
18-1547-03 64 x 64 mm
18-1547-04 80 x 57 mm



Scoville

18-1548-01 41 x 38 mm
18-1548-02 67 x 44 mm



Taylor

18-1549-01 32 x 75 mm
18-1549-02 42 x 100 mm



Meyering-Scoville

18-1550-01 50 x 25 mm
18-1550-02 70 x 25 mm
18-1550-03 83 x 25 mm

gezahnt
saw edge
dentelée
dentada



Cloward

18-1560-01 25,0 cm/9½"
Sperrer allein, spreader only
ecarteur seule, separador solo

18-1560-00
Set mit 5 gezahnten Valven 18-1561-40 - 18-1561-60
Set with 5 toothed blades 18-1561-40 - 18-1561-60
Jeu avec 5 valves dentelées 18-1561-40 - 18-1561-60
Juego con 5 valvas dentadas 18-1561-40 - 18-1561-60



Valve, gezahnt
Blade, saw edge
Valve, dentelée
Valva, dentada

18-1561-40 40 mm
18-1561-45 45 mm
18-1561-50 50 mm
18-1561-55 55 mm
18-1561-60 60 mm



Cloward

18-1562-01 17,0 cm/6¾"
Sperrer allein, spreader only
ecarteur seule, separador solo

18-1562-00
Set mit 5 stumpfen Valven 18-1562-40 - 18-1562-60
Set with 5 blunt blades 18-1562-40 - 18-1562-60
Jeu avec 5 valves mouses 18-1562-40 - 18-1562-60
Juego con 5 valvas romas 18-1562-40 - 18-1562-60



Valve, stumpf
Blade, blunt
Valve, mousse
Valva, roma

18-1562-40 40 mm
18-1562-45 45 mm
18-1562-50 50 mm
18-1562-55 55 mm
18-1562-60 60 mm



Verschiedene Nagelinstrumente
Miscellaneous Nail Instruments
Instrumentes divers pour les ongles
Instrumentos diversos para las uñas



19



Nagelfeile
Nail File
Lime à ongles
Lima para uñas

19-1620 10,0 cm/4"
19-1621 12,0 cm/4¾"



Nagelfeile
Nail File
Lime à ongles
Lima para uñas

19-1622 11,0 cm/4½"



19-1625
Schwestern Set
Set for nurses
Jeu pour une infirmière
Juego para una enfermera



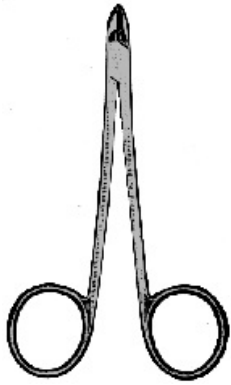

19-1628
 10,0 cm/4"
 Hautzange
 Cuticle Nippers
 Pince à envies
 Pinza para cuticulares

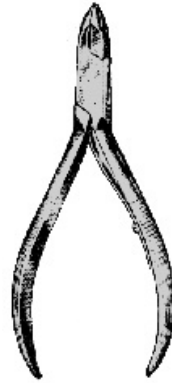

19-1629
 10,5 cm/4¼"
 Hautzange
 Cuticle Nippers
 Pince à envies
 Pinza para cuticulares



19-1630
 14,5 cm/5¾"
 Pedicure-Zange
 Nail Nippers
 Pincés à ongles
 Alicates corta-uñas

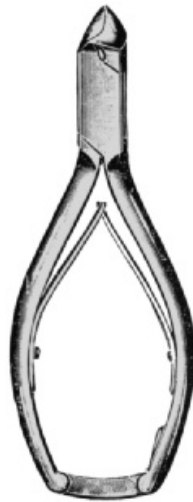

19-1631
 14,5 cm/5¾"
 Kopfschneider
 Nail Nippers
 Pincés à ongles
 Alicates corta-uñas

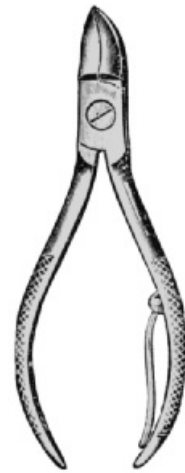

19-1632
 13,0 cm/5"
 Nagelzange
 Nail Nippers
 Pincés à ongles
 Alicates corta-uñas

109



19-1633
12,0 cm/4¾"
Nagelzange
Nail Nippers
Pincès à ongles
Alicates corta-uñas



19-1634 12,0 cm/4¾"
19-1635 13,5 cm/5¼"
Nagelzange
Nail Nippers
Pincès à ongles
Alicates corta-uñas



19-1636
13,0 cm/5"
Nagelzange
Nail Nippers
Pincès à ongles
Alicates corta-uñas

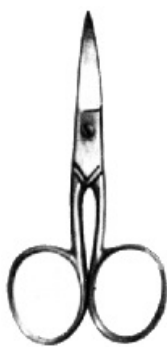

Nagelschere
Nail Scissors
Ciseaux à ongles
Tijeras para uñas

19-1638 9,0 cm/3½"
19-1639 10,5 cm/4½"
gebogen
curved
courbes
curvas



Nagelschere
Nail Scissors
Ciseaux à ongles
Tijeras para uñas

19-1640 9,0 cm/3½"
gebogen
curved
courbes
curvas



Instrumentos para uñas



19-1641
 17,0 cm/6³/₄"
 Fingerring-Säge
 Finger Ring Saw
 Scie pour bagues
 Sierra para abrir anillos



19-1642
 16,0 cm/6¹/₄"
 Fingerring-Säge, verchromt
 Finger Ring Saw, chrome plated
 Scie pour bagues, chromée
 Sierra para abrir anillos, cromada

19-1643
 Sägeblatt
 Saw blade
 Lame de scie
 Hoja de sierra

19-1644
 Sägeblatt
 Saw blade
 Lame de scie
 Hoja de sierra



19-1651
 Bohrer, Satz
 Drill, set
 Perforateurs, jeu
 Perforadores, juego



19-1650
 Fingernagel-Bohrer, Satz
 Finger nail drill, set
 Perforateurs pour les ongles, jeu
 Perforadores para uñas, juego



19-1652
 14,0 cm/5¹/₂"
 Nagelausreißzange
 Forceps for tearing out toe and finger nails
 Pincers pour l'extraction des ongles
 Pinzas para arrancar uñas



Feldmann
 19-1653
 10,0 cm/4"
 Finger- und Zehenkompressorium
 Tourniquet for fingers and toes
 Appareil à compression pour les
 doigts et les orteils
 Compresor para los dedos de
 la mano y del pie

**Scheren, Supercut-Scheren
Scissors, Supercut Scissors
Ciseaux, Ciseaux Supercut
Tijeras, Tijeras Supercut**





Standard

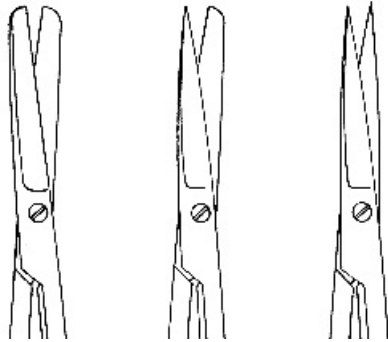

Fig. 1	Fig. 2	Fig. 3
20-1701	20-1711	20-1721
20-1702	20-1712	20-1722
20-1703	20-1713	20-1723
20-1704	20-1714	20-1724
20-1705	20-1715	20-1725
20-1706	20-1716	20-1726
20-1707	20-1717	20-1727
20-1708	20-1718	20-1728
20-1709	20-1719	20-1729



Standard

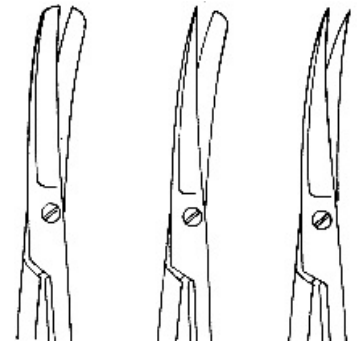

Fig. 1	Fig. 2	Fig. 3
10,5 cm/4¼"	20-1731	20-1741
11,5 cm/4½"	20-1732	20-1742
13,0 cm/5"	20-1733	20-1743
14,5 cm/5½"	20-1734	20-1744
15,5 cm/6"	20-1735	20-1745
16,5 cm/6½"	20-1736	20-1746
17,5 cm/7"	20-1737	20-1747
18,5 cm/7¼"	20-1738	20-1748
20,0 cm/8"	20-1739	20-1749

20



Graziil

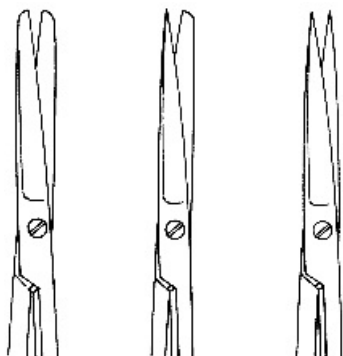

Fig.1	Fig. 2	Fig. 3
20-1761	20-1763	20-1765
20-1762	20-1764	20-1766



Graziil

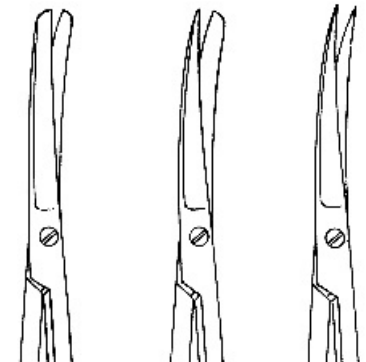
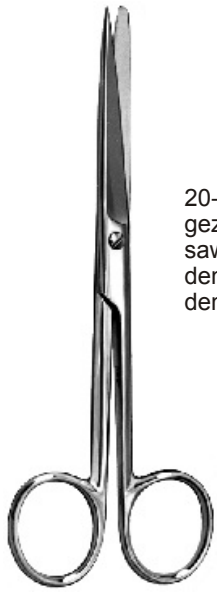

Fig. 1	Fig. 2	Fig. 3
13,0 cm/5"	20-1767	20-1771
14,5 cm/5½"	20-1768	20-1772



20-1773

20-1775
gezahnt
saw edge
dentelés
dentadas

Deaver
14,5 cm/5½"

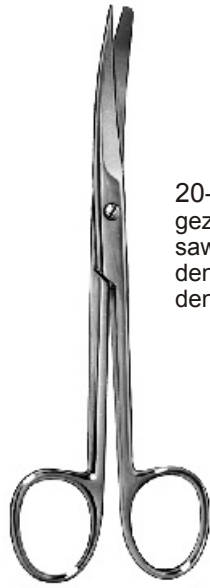

20-1774

20-1776
gezahnt
saw edge
dentelés
dentadas



Goldmann-Fox
13,0 cm/5"



20-1777-01 20-1777-02

Inzisionsschere
Incision Scissors
Ciseaux à incision
Tijeras para incisión



20-1780 13,0 cm/5"
20-1781 14,5 cm/5½"



Richter
20-1783 14,5 cm/5½"



20-1785

20-1787
gezahnt
saw edge
dentelés
dentadas

Mixter
15,5 cm/6"



20-1786

20-1788
gezahnt
saw edge
dentelés
dentadas



20- 1791
20- 1792
20- 1793
20- 1794

Mayo
14,5 cm/5½"
15,0 cm/6"
17,0 cm/6¾"
23,0 cm/9"



20- 1796
20- 1797
20- 1798
20-1799



20-1801
20-1802
20-1802-21

Mayo-Stillé
15,0 cm/6"
17,0 cm/6¾"
21,0 cm/8¼"



20-1803
20-1804
20-1804-21



20-1806

Mayo-Noble
17,0 cm/6¾"



20-1808



20-1810

Mayo-Harrington
23,0 cm/9"

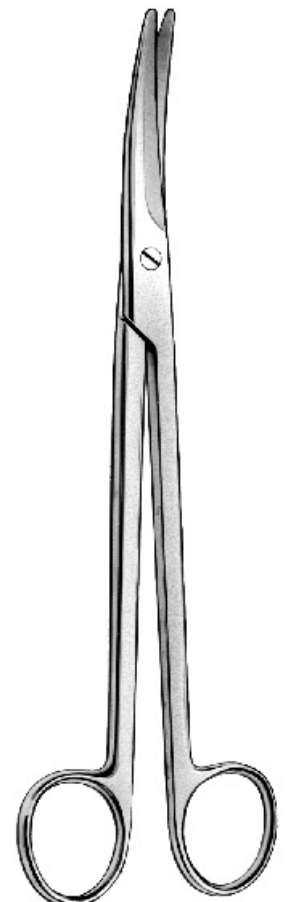

20-1811

20



Bauchdecken-Scheren
Abdominal Scissors
Ciseaux abdominaux
Tijeras abdominales



20-1812
20-1814

Doyen
16,0 cm/6¼"
17,5 cm/7"

20-1813
20-1815



20-1817

Mayo-Lexer
16,0 cm/6¼"



20-1818



20-1819

Baby-Lexer
10,0 cm/4"



20-1820



Metzenbaum
14,5 cm/5½"



Fig. 1
20-1821



Fig. 2
20-1831

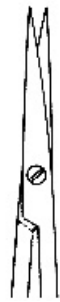

Fig. 3
20-1841



Metzenbaum
14,5 cm/5½"



Fig. 1
20-1851



Fig. 2
20-1861



Fig. 3
20-1871

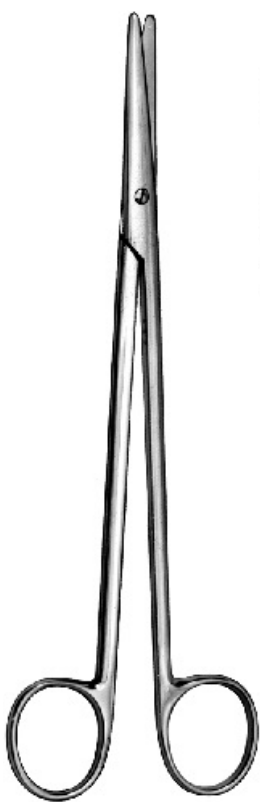

Metzenbaum



Fig. 1
20-1822
20-1823
20-1824
20-1825
20-1826
20-1827



Fig. 2
20-1832
20-1833
20-1834
20-1835
20-1836
20-1837

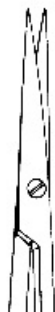
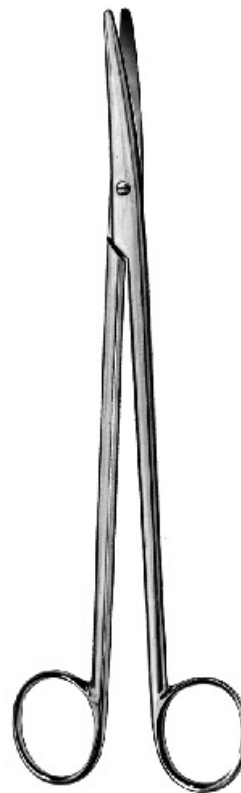

Fig. 3
20-1842
20-1843
20-1844
20-1845
20-1846
20-1847



Metzenbaum



Fig. 1
20-1852
20-1853
20-1854
20-1855
20-1856
20-1857



Fig. 2
20-1862
20-1863
20-1864
20-1865
20-1866
20-1867



Fig. 3
20-1872
20-1873
20-1874
20-1875
20-1876
20-1877

18,0 cm/7"
20,0 cm/8"
23,0 cm/9"
25,0 cm/10"
28,0 cm/11"
30,0 cm/12"

20

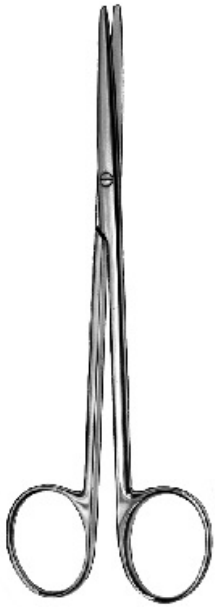

20-1880
20-1881
20-1882

Metzenbaum, Fino

14,5 cm/5½"
15,0 cm/6"
18,0 cm/7"



20-1884
20-1885
20-1886



20-1887-01

Metzenbaum-Lahey

14,0 cm/4¾"



20-1887-02

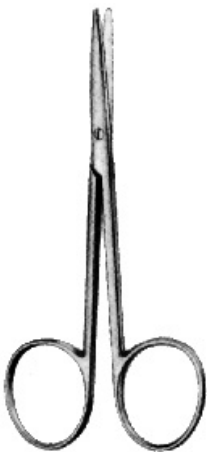

**Metzenbaum
(Strabismus)**
11,5 cm/4½"



20-1888

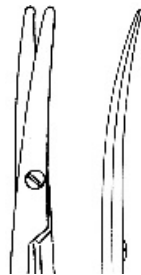

20-1889



Chirurgische und gynäkologische Schere
Operating and gynecological Scissors
Ciseaux à chirurgie et à gynécologie
Tijeras para cirugía y ginecología

Wertheim

20-1890 14,5 cm/5½"
20-1891 19,5 cm/7¾"
20-1892 22,5 cm/9"



Sims

Fig. 1
20-1893 20,0 cm/8"
20-1895 23,0 cm/9"

Fig. 2
20-1896 20,0 cm/8"
20-1898 23,0 cm/9"

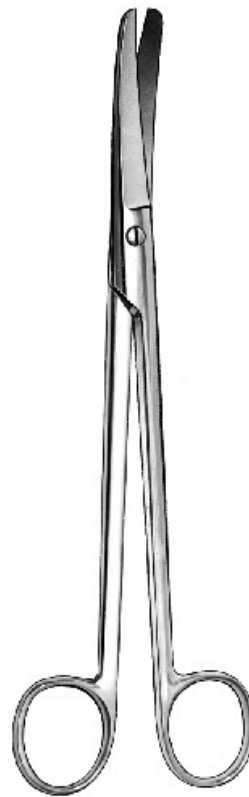

Sims

Fig. 1
20-1899 20,0 cm/8"
20-1901 23,0 cm/9"

Fig. 2
20-1902 20,0 cm/8"
20-1904 23,0 cm/9"



20-1905-16
20-1905-18

Feine Scheren
Delicate Scissors
Ciseaux fins
Tijeras finas

Kelly
16,0 cm/6¼"
18,0 cm/7"



20-1906-16
20-1906-18

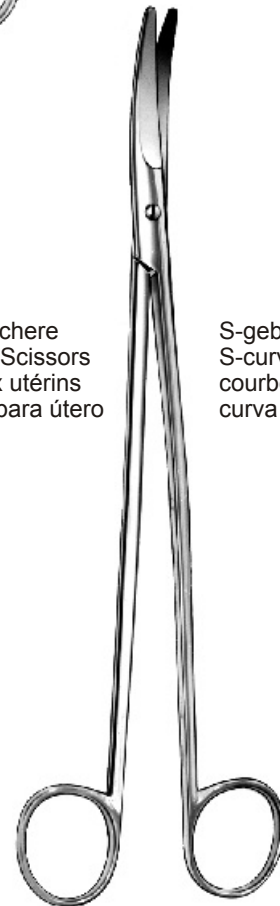

Siebold
20-1907 24,0 cm/9½"

Uterusschere
Uterine Scissors
Ciseaux utérins
Tijeras para útero

S-gebogen
S-curved
courbes forme S
curva forma S



20-1908

Kephalotomie-Scheren
Cephalotomy Scissors
Ciseaux à céphalotomie
Tijeras para cefalotomia

Dubois
27 cm/10½"

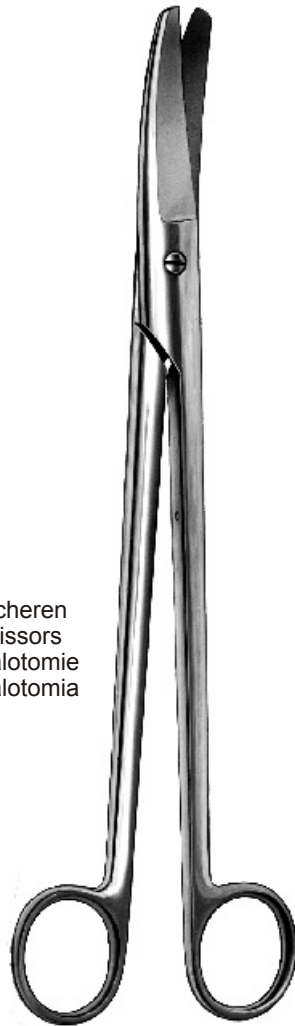

20-1909



20-1910
14,5 cm/5½"

Dammscheren
Perineum Scissors
Ciseaux à périnée
Tijeras para perineo

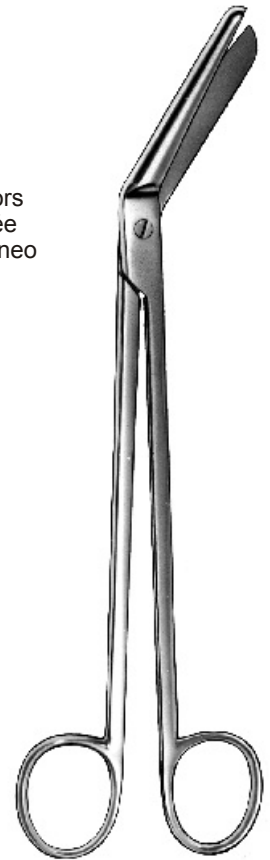

**Braun-
Stadler**

20-1911
22 cm/8¾"



Dammschere
Perineum Scissors
Ciseaux à périnée
Tijeras para perineo

Waldmann
18,0 cm/7¼"

20-1910-18



Nabelschnurscheren
Umbilical Scissors
Ciseaux pour le cordon ombilical
Tijeras umbilicales

Schumacher
15,5 cm/6¼"

20-1912



Nabelschnurscheren
Umbilical Scissors
Ciseaux pour le cordon ombilical
Tijeras umbilicales

Busch

20-1913 13,0 cm/5"
20-1914 16,0 cm/6¼"



Mod. USA
10,5 cm/4¼"

20-1915



Feine Chirurgische Scheren
Delicate Operating Scissors
Ciseaux chirurgicaux fins
Tijeras finas para cirugía

20-1916

Joseph
14,5 cm/5½"



20-1917

Präparierscheren
Dissecting Scissors
Ciseaux à dissection
Tijeras para preparaciones



Kilner

20-1918 13,0 cm/5"
20-1919 15,0 cm/6"

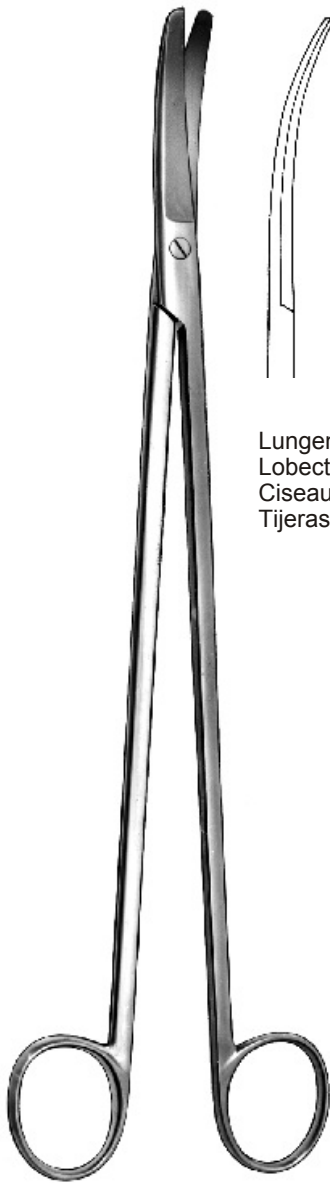

Lungenlappenschere
Lobectomy Scissors
Ciseaux à lobectomie
Tijeras para lobectomia

Crafoord
30,0 cm/12"
20-1920

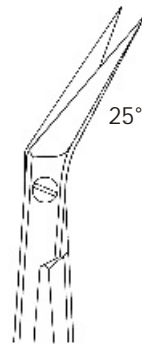

20-1922-01

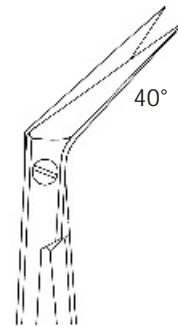

20-1922-02

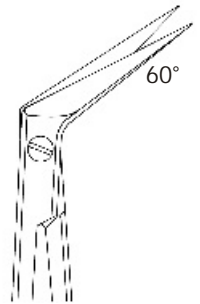

20-1922-03

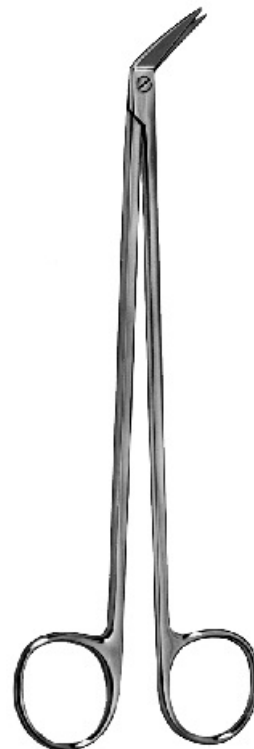

Potts-Smith
19,0 cm/7½"

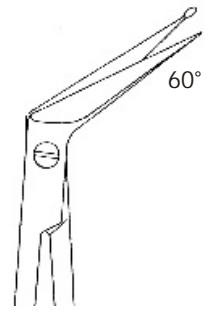

20-1922-04

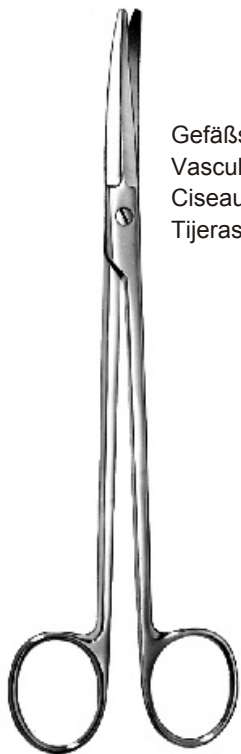

Gefäßschere
Vascular Scissors
Ciseaux vasculaires
Tijeras vasculares

Potts-Smith

20-1923 19,0 cm/7½"



Präparierschere
Dissecting Scissors
Ciseaux à dissection
Tijeras para preparaciones

Reynolds

20-1924 16,0 cm/6¼"



Gefäßschere
Vascular Scissors
Ciseaux vasculaires
Tijeras vasculares

Satinsky

20-1925 24,5 cm/10"



Knorpelschere
Cartilage Scissors
Ciseaux pour le cartilage
Tijeras para cartílago

Mc Indoe

20-1926 19,0 cm/7½"

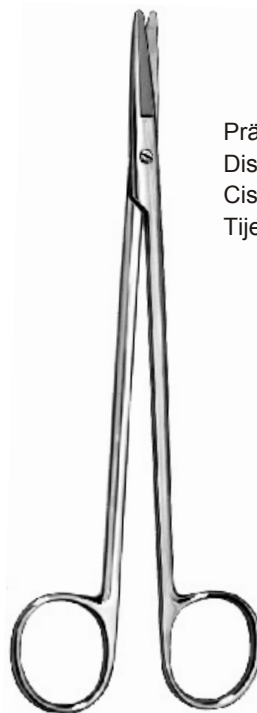

Präparierscheren
Dissecting Scissors
Ciseaux à dissection
Tijeras para preparaciones

20-1927



Tönis
18,0 cm/7"

20-1928

20
20



Präparierschere
Dissecting Scissors
Ciseaux à dissection
Tijeras para preparaciones

Adson-Tönnis

20-1929 17,5 cm/7"



Dandy

20-1930 17,0 cm/6¾"



Gefäßschere
Vascular Scissors
Ciseaux vasculaires
Tijeras vasculares

Strully

20-1931 22,0 cm/8½"

Gefäß- und Coronarschere
Vascular and Coronary Scissors
Ciseaux vasculaires et coronaires
Tijeras para vasculares y coronarias



20-1932 11,5 cm/4½"



Duraschere
Dura Scissors
Ciseaux pour la dure-mère
Tijeras para dura-madre

Schmieden

20-1933 17,0 cm/6¾"

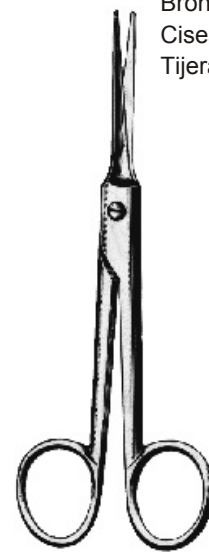

Bronchialschere
Bronchial Scissors
Ciseaux pour les bronches
Tijeras para bronquios

20-1934 14,5 cm/6"



Heymann

20-1935 18,0 cm/7"

Nasenscheren
Nasal Scissors
Ciseaux nasaux
Tijeras nasales



Seiler

20-1937 17,0 cm/6¾"

Tonsillenscheren, Tonsil Scissors, Ciseaux pour les amygdales, Tijeras para amigdalas



Böttcher

20-1940 18,0 cm/7"



Prince

20-1941 17,5 cm/7"

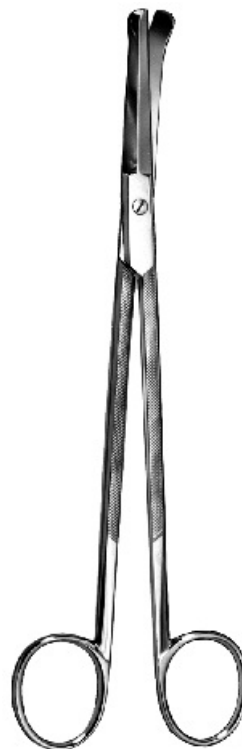

Good

20-1942 19,0 cm/7½"



Dean

20-1943 17,0 cm/6¾"



20-1945

Ligaturschere
11,5 cm/4½"



20-1946



Littauer

20-1947 14,0 cm/5½"

gebogen, curved
courbes, curvas

20-1948G 9,0 cm/3½"
20-1950G 12,0 cm/4¾"



Spencer

20-1948 9,0 cm/3½"
20-1949 10,5 cm/4"
20-1950 12,0 cm/4¾"

Drahtschere
Wire Cutting Scissors
Coupe-fils alambre
Cizallas para cortar alambre



Heath

20-1951 15,0 cm/6"



Universal

20-1952 12,0 cm/4¾"

Nagelspalt-Scheren, Nail Splitting Scissors
Ciseaux à fendre les ongles, Tijeras para hender las uñas



20-1954

Sistrunk
13,0 cm/5"



20-1955



20-1956-15 15,0 cm/6"

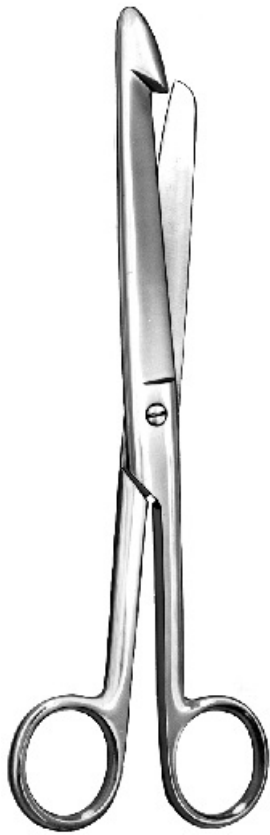

Darmschere

20-1961 21,0 cm/8¼"

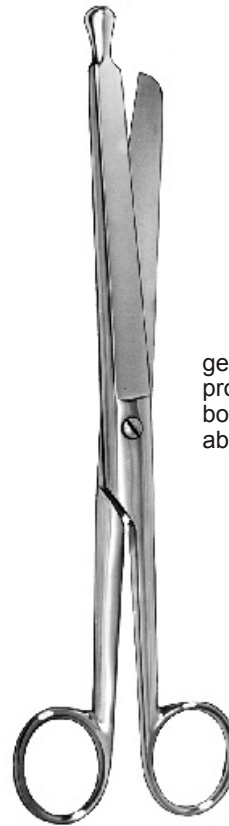

geknoepft
probe-pointed
boutonnés
abotonadas

Darmschere

20-1963 21,0 cm/8¼"



Anatomie-Scheren
Dissecting Scissors
Ciseaux à dissection
Tijeras para disección



20-1965	11,5 cm/4½"	20-1968
20-1966	13,0 cm/5"	20-1969
20-1967	14,5 cm/5½"	20-1970



20-1791-SC
20-1793-SC

Mayo

14,5 cm/5½"
17,0 cm/6¾"



20-1796-SC
20-1798-SC



20-1801-SC
20-1802-SC

Mayo-Stille

15,0 cm/6"
17,0 cm/6¾"



20-1803-SC
20-1804-SC



20-1817-SC

Mayo-Lexer
16,0 cm/6¼"



20-1818-SC



20-1821-SC

Metzenbaum
14,5 cm/5½"



20-1851-SC

Metzenbaum
14,5 cm/5½"

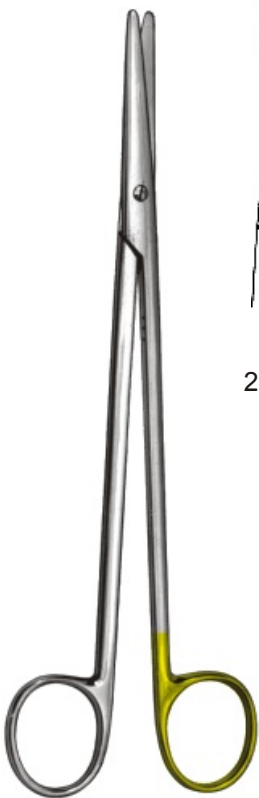

20-1822-SC

Metzenbaum
18,0 cm/7"

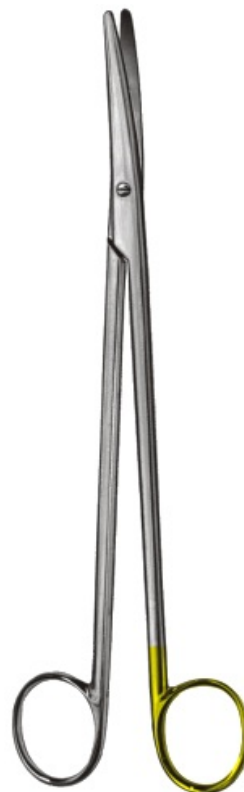

20-1852-SC

Metzenbaum
18,0 cm/7"



20



20-1880-SC

Metzenbaum, Fino
14,5 cm/5½"



20-1884-SC



Metzenbaum (Strabismus)
11,5 cm/4½"

20-1888-SC

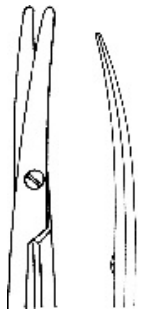

20-1889-SC



Lister

20-1979-SC 14,0 cm/5½"
20-1980-SC 18,0 cm/7"
20-1981-SC 20,0 cm/8"



Irischere
11,5 cm/4¾"

20-7458-SC

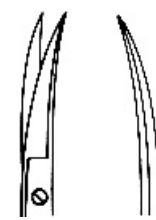

20-7459-SC



Stevens
11,0 cm/4½"
stumpf
blunt
mousses
romas

20-7496-SC

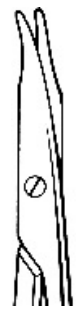

20-7497-SC

**Instrumente für Verband und Gips
Bandage and Plaster Instruments
Instruments pour pansements et plâtre
Instrumentos para vendajes y yeso**



201



Smith

21-1971 16,0 cm/6¼"
21-1972 18,0 cm/7"
21-1973 20,0 cm/8"
21-1974 23,0 cm/9"

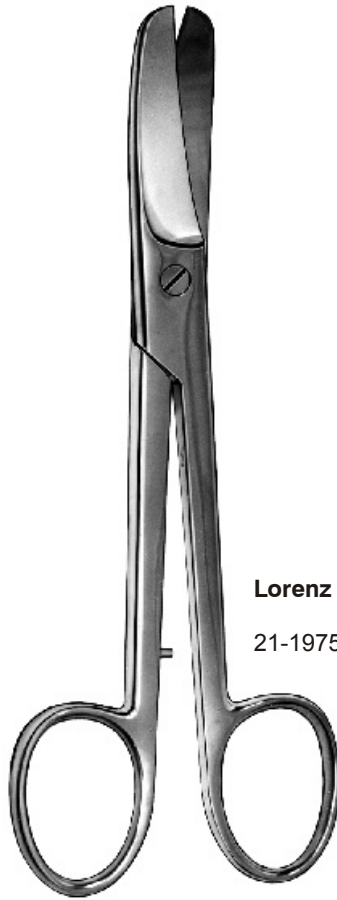

Lorenz

21-1975 23,0 cm/9"



Knowles
14,5 cm/5½"

21-1976 21-1976G

gerade, straight gebogen, curved
droits, rectas courbes, curvas



Lister

21-1977 9,0 cm/3½"
21-1978 11,0 cm/4½"
21-1979 14,0 cm/5½"
21-1980 18,0 cm/7"
21-1981 20,0 cm/8"

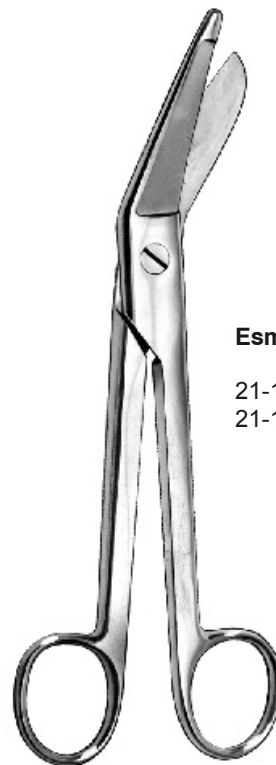

Esmarch

21-1982 20,0 cm/8"
21-1983 23,0 cm/9"



Bruns
24,0 cm/9½"

21-1984

glatt, smooth
lisses, lisas

21-1985

gezahnt, saw edge
dentelés, dentadas



Lister

21-1986S
18,0 cm/7"

schwarz
black
noir
negro

21-1987S
15,0 cm/6"

schwarz
black
noir
negro

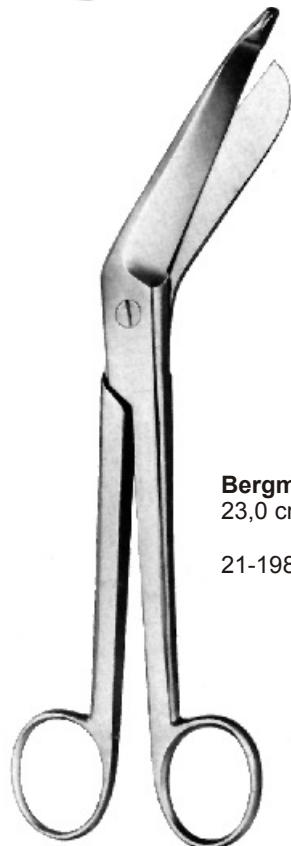

Bergmann
23,0 cm/9"

21-1988



Lister-Excentric
16,0 cm/6¼"

21-1989

21

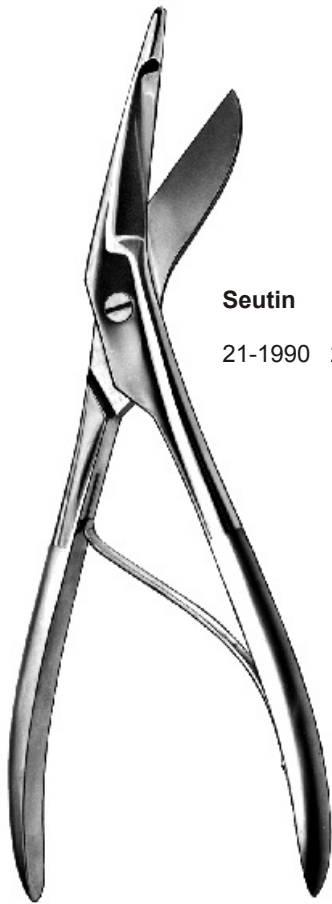

Seutin
21-1990 23,0 cm/9"

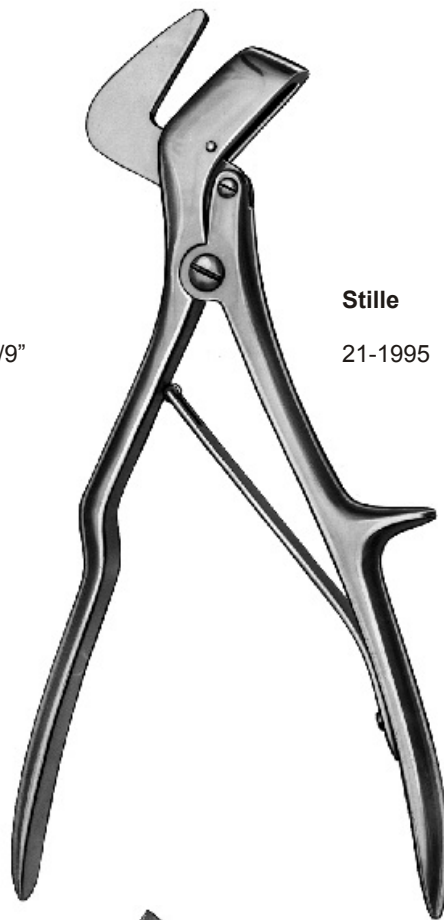

Stille
21-1995 24,0 cm/9½"



Esmarch
18,0 cm/7"
21-2021



Reiner
18,0 cm/7"
21-2022



Hopkins
20,0 cm/8"
21-2024

verstärkter Rücken
reinforced back
à dos renforcé
lomo reforzado

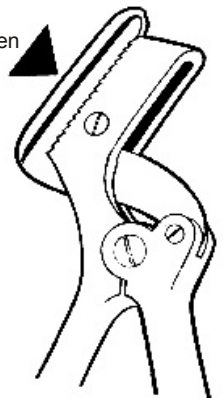

21-1999
26,0 cm/10½"

21-2000
37,0 cm/14½"



Stille
21-1996 23,0 cm/9"
21-1997 26,0 cm/10½"
21-1998 37,0 cm/14½"



Engel

21-2028



Wolff

21-2032 18,0 cm/7"
21-2033 24,0 cm/9½"



Henning

21-2034 28,0 cm/11"

201



Haglund-Stille

21-2036 28,0 cm/11"

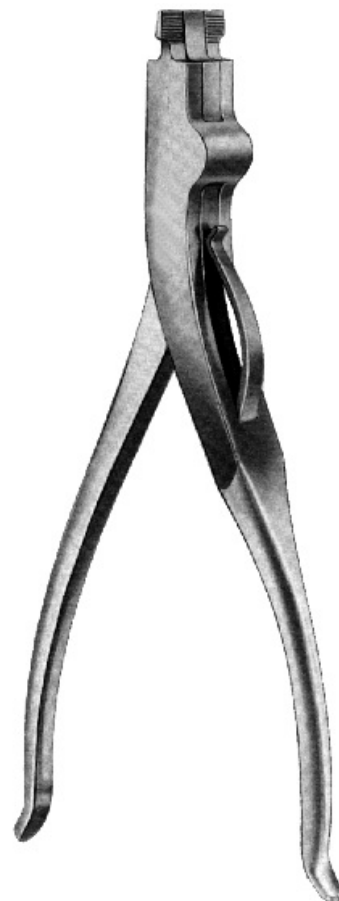

USA-Modell

21-2037 23,0 cm/9"

Instrumente mit Hartmetalleinlagen
Instruments with Tungsten Carbide Inserts
Instrumentos avec mors en carbure de tungstène
Instrumentos con placas de carburo tungsteno



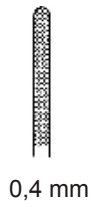

1,8 mm



22-2001
13,0 cm/5"

2,0 mm



22-2002
14,5 cm/5½"

2,0 mm



22-2003
16,0 cm/6"

2,0 mm



22-2004
18,0 cm/7"

2,2 mm



22-2005
20,0 cm/8"

2,8 mm



22-2006
25,0 cm/10"

2,8 mm



22-2007
30,0 cm/12"



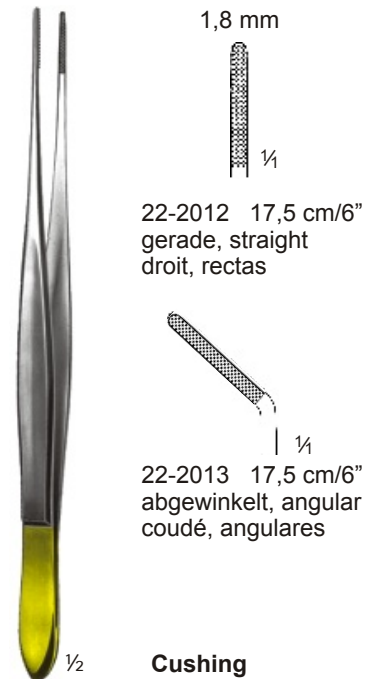
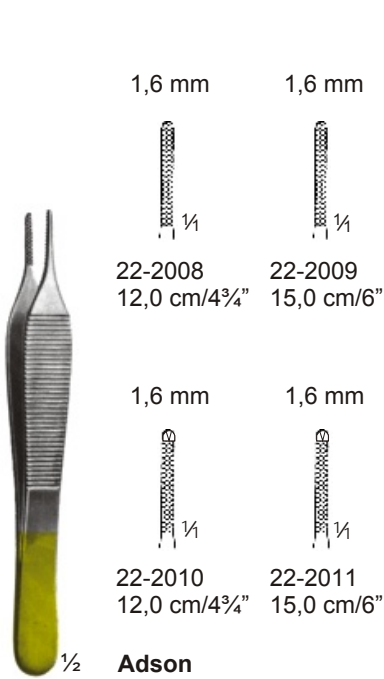

22

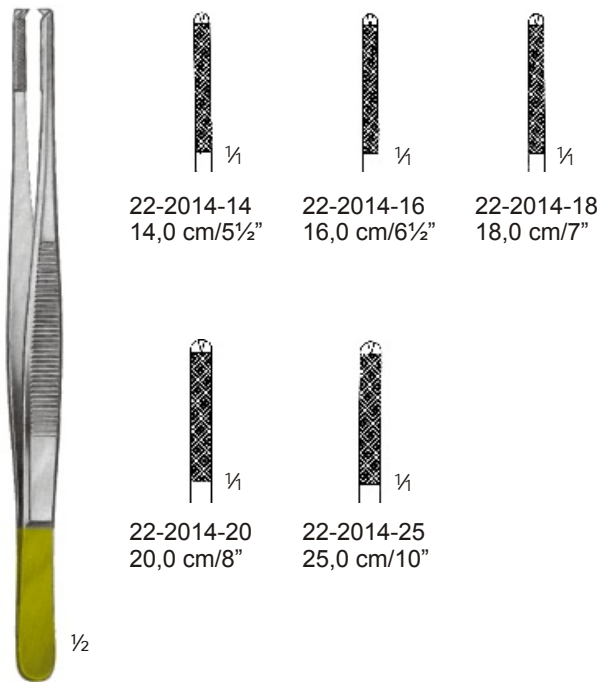

Chir. Pinzette



Potts-Smith

- 22-2015 18,0 cm/7"
- 22-2016 21,0 cm/8¼"
- 22-2017 25,0 cm/10"



Wangensteen

- 22-2018 15,0 cm/6"
- 22-2019 23,0 cm/9"

**ohne Sperre, without ratchet
sans crémaillère, sin cremallera**



22-2095-14 14,0 cm/5½"
gerade
straight
droite
recta



22-2096-14
gebogen
curved
courbe
curva



22-2097-14 14,0 cm/5½"
gerade
straight
droite
recta



22-2098-14
gebogen
curved
courbe
curva



Castroviejo

**mit Sperre, with ratchet
avec crémaillère, con cremallera**



22-2099-14 14,0 cm/5½"
22-2099-18 18,0 cm/7"
22-2099-21 21,0 cm/8¼"
gerade
straight
droite
recta



22-2100-14
22-2100-18
22-2100-21
gebogen
curved
courbe
curva



22-2101-14 14,0 cm/5½"
22-2101-18 18,0 cm/7"
22-2101-21 21,0 cm/8¼"
gerade
straight
droite
recta



22-2102-14
22-2102-18
22-2102-21
gebogen
curved
courbe
curva



Kalt
22-2104 14,0 cm/5½"



Arruga
16,0 cm/6¼"



22-2105
gerade
straight
droite
recta



22-2106
gebogen
curved
courbe
curva



Barraquer
13,5 cm/5¼"

22-2110
gerade
straight
droite
recta

22-2111
gebogen
curved
courbe
curva



13,0 cm = 1,2 mm
14,5 cm = 1,4 mm
16,0 cm = 1,5 mm
18,0 cm = 1,7 mm
20,0 cm = 2,0 mm
23,0 cm = 2,2 mm
26,0 cm = 2,4 mm

French

- 22-2113 13,0 cm/5"
- 22-2114 14,5 cm/5½"
- 22-2115 16,0 cm/6¼"
- 22-2116 18,0 cm/7"
- 22-2117 20,0 cm/8"
- 22-2118 23,0 cm/9"
- 22-2119 26,0 cm/10¼"



Derf

- 22-2192 12,5 cm/5"



Mayo-Hegar

- 22-2199 30,0 cm/12"

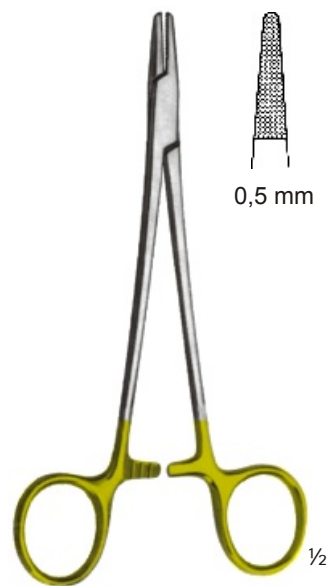

Mayo-Hegar

- 22-2200 14,0 cm/5½"
- 22-2201 16,0 cm/6¼"
- 22-2202 18,0 cm/7¼"
- 22-2203 20,0 cm/8"
- 22-2204 23,0 cm/9"
- 22-2205 26,0 cm/10¼"



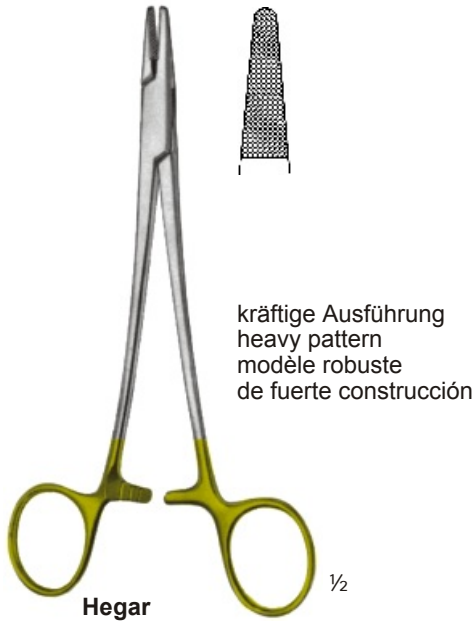

Hegar

22-2206 20,0 cm/8"
22-2207 24,0 cm/9½"



Olsen-Hegar

22-2208 14,0 cm/5½"



Olsen-Hegar

22-2209 17,0 cm/6¼"



Olsen-Hegar

22-2210 18,0 cm/7"



Wangenstein

22-2211 27,0 cm/10½"



Finochietto

22-2212 26,0 cm/10¼"
 22-2213 20,0 cm/8"



½

½

22



Baumgartner

22-2214 13,0 cm/5"

½



Crile-Wood

22-2215 15,0 cm/6"
 22-2216 18,0 cm/7"
 22-2217 20,0 cm/8"
 22-2218 23,0 cm/9"
 22-2228 26,0 cm/10¼"



½



De Bakey

22-2216D 18,0 cm/7"
 22-2217D 20,0 cm/8"
 22-2218D 23,0 cm/9"
 22-2228D 26,0 cm/10¼"



½



Heaney

22-2219 20,0 cm/8"
22-2220 26,0 cm/10¼"

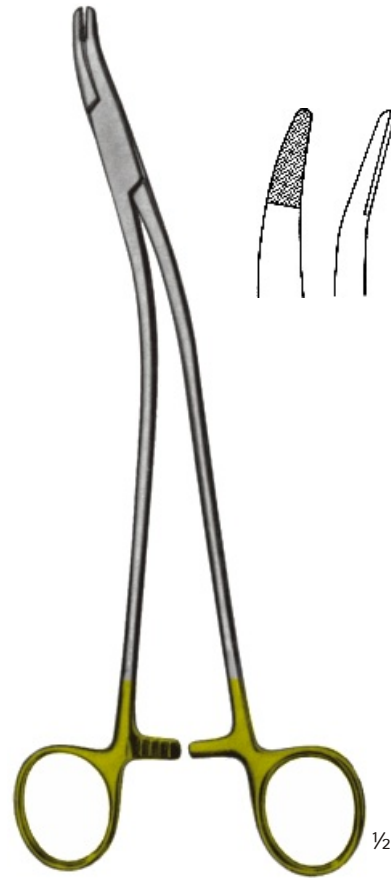

Stratte

22-2221 23,0 cm/9"



Mathieu

22-2222 14,0 cm/5½"
22-2223 17,0 cm/6½"
22-2224 20,0 cm/8"



Halsey

13,0 cm/5"

22-2225

22-2226

glatt
smooth
lisse
lisa

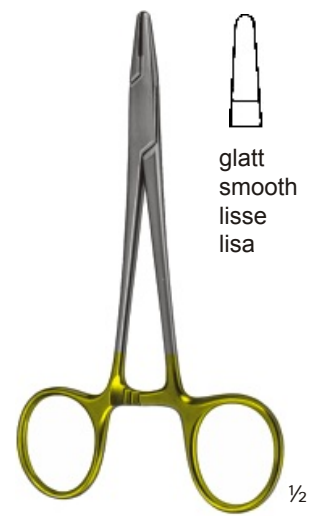

Webster

22-2227 13,0 cm/5"

glatt
smooth
lisse
lisa



Mathieu

22-2231 17,0 cm/6½"
22-2232 20,0 cm/8"



kräftige Ausführung
heavy pattern
modèle robuste
de fuerte construcción

für den Veterinär-Bereich
for the veterinary field
pour des vétérinaires
para los veterinarios

Mathieu

22-2233-17 17,0 cm/6½"
22-2233-20 20,0 cm/8"

22

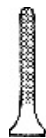

schmales Modell
delicate pattern
modèle étroit
modelo estrecho

French-Mathieu

22-2234 14,0 cm/5½"
22-2235 17,0 cm/6½"
22-2236 20,0 cm/8"

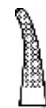

gebogenes Modell
curved pattern
modèle courbe
modelo curvo

Mathieu

22-2237 14,0 cm/5½"
22-2238 17,0 cm/6½"
22-2239 20,0 cm/8"



Sarot

22-2240 18,0 cm/7"
22-2241 20,0 cm/8"
22-2242 26,0 cm/10¼"



Masson

22-2244 27,0 cm/10½"



Olsen-Hegar

22-2245 14,0 cm/5½"

kräftige Ausführung
heavy pattern
modèle robuste
de fuerte construcción

für den Veterinär-Bereich
for the veterinary field
pour des vétérinaires
para los veterinarios



Olsen-Hegar

22-2246 17,0 cm/6¾"



für sehr feine Nadeln
for fine needles
pour des aiguilles très fines
para agujas finas

Baby-Olsen-Hegar
11,5 cm/4½"

22-2247	22-2248
gerieft	glatt
serrated	smooth
striée	lisse
estriada	lisa

22

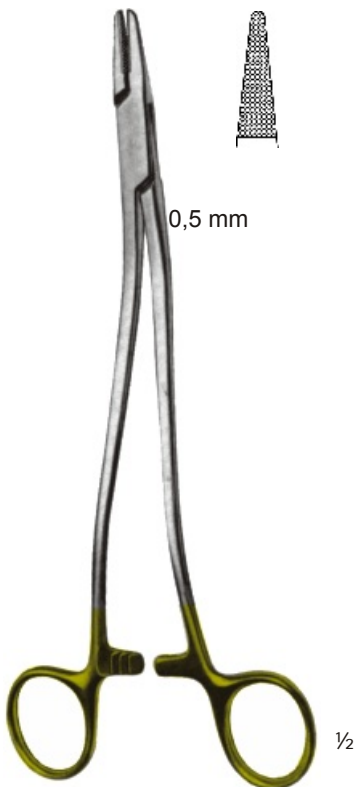

0,5 mm

Bozemann

22-2250 20,0 cm/8"
22-2251 24,0 cm/9½"
22-2252 26,0 cm/10¼"



Gillies-Baby

22-2253-11 11,0 cm/4"

Gillies

22-2253-16 16,0 cm/6¼"





Gewebefaßzange
Tissue Seizing Forceps
Pince à saisir les tissus
Pinza para coger tejidos

Duval

22-2254 20,0 cm/8"



Babcock

22-2255 16,0 cm/6¼"
22-2256 20,0 cm/8"



Allis

22-2257 16,0 cm/6¼"
22-2258 19,0 cm/7½"



Standard
14,5 cm/5½"

½



Standard
14,5 cm/5½"

gerade
straight
droits
rectas

gebogen
curved
courbes
curvas



Fig. 1
22-2260



Fig. 2
22-2261



Fig. 3
22-2262

22-2263

22-2264

22-2265

22



Parametrium

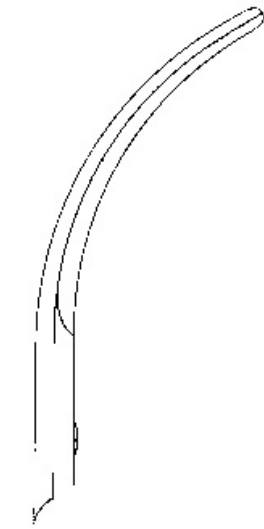

22-2268-22
22,5 cm/9"



22-2268-23
23,0 cm/9"

½



Lister

22-2269
18,0 cm/7"

½



Mayo

22-2270
22-2271

14,5 cm/5½"
17,0 cm/6¾"

Mayo

22-2272
22-2273



Mayo-Stille

22-2274
22-2275

15,0 cm/6"
17,0 cm/6¾"

Mayo-Stille

22-2276
22-2277

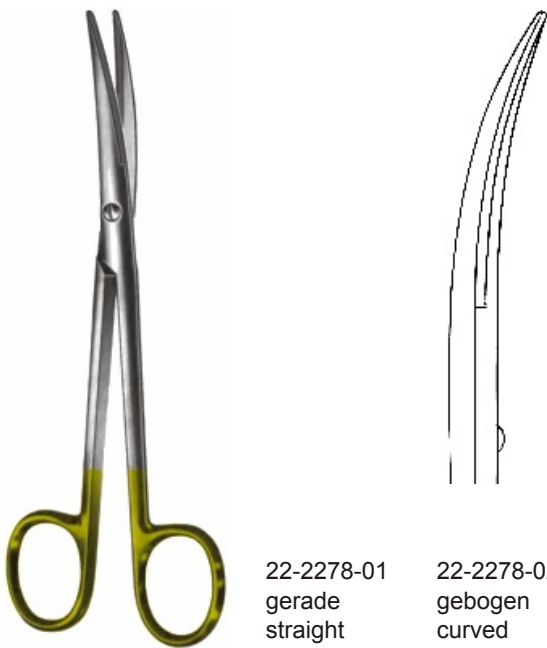

Mayo-Lexer
16,5 cm/6½"

22-2278-01
gerade
straight
droits
rectas

22-2278-02
gebogen
curved
courbes
curvas

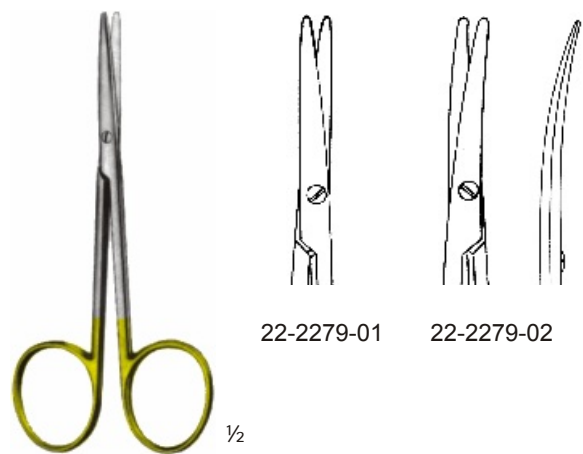

**Strabismus
(Metzenbaum)**
11,5 cm/4½"

22-2279-01

22-2279-02



Metzenbaum

22-2280	14,5 cm/5½"
22-2281	18,0 cm/7"
22-2282	20,0 cm/8"
22-2283	23,0 cm/9"

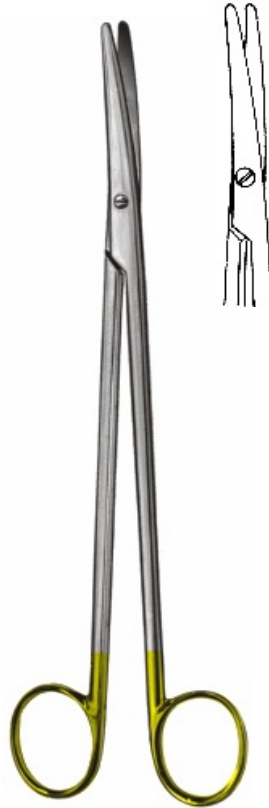

22-2284
22-2285
22-2286
22-2287



Metzenbaum, Fino

22-2280F	14,5 cm/5½"	22-2284F
22-2281F	18,0 cm/7"	22-2285F
22-2282F	20,0 cm/8"	22-2286F
22-2283F	23,0 cm/9"	22-2287F



22



Tönnis-Adson

22-2288 17,0 cm/7"



Irisschere
11,5 cm/4¾"



22-2289-01



22-2289-02



gezahnte Schneide
 saw edge
 lame de scie
 corte con dientes

Universal

22-2290 12,0 cm/5"



22-2291 12,5 cm/5"



22-2292 17,5 cm/7"

für Drähte bis 1,6 mm Ø
 for wires up to 1,6 mm Ø
 pour fils jusqu'a 1,6 mm Ø
 para hilos hasta 1,6 mm Ø



22-2293 22,0 cm/8¾"

für Drähte bis 2,5 mm Ø
 for wires up to 2,5 mm Ø
 pour fils jusqu'a 2,5 mm Ø
 para hilos hasta 2,5 mm Ø

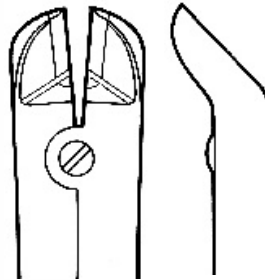

22-2294-16 16,0 cm/6½"

für Drähte bis 1,6 mm Ø
 for wires up to 1,6 mm Ø
 pour fils jusqu'a 1,6 mm Ø
 para hilos hasta 1,6 mm Ø



18,0 cm/7"



Fig. 1
22-2296-01



Fig. 2
22-2296-02



Fig. 3
22-2296-03

22



22-2297-18 18,0 cm/7"

für weiche Drähte bis 2,0 mm Ø
for soft wires up to 2,0 mm Ø
pour fils mous jusqu'à 2,0 mm Ø
para hilos blandos hasta 2,0 mm Ø

für harte Drähte bis 1,7 mm Ø
for hard wires up to 1,7 mm Ø
pour fils durs jusqu'à 1,7 mm Ø
para hilos duros hasta 1,7 mm Ø



Drahtziehzange
Wire Seizing Forceps
Pinces à saisir le fil
Pinzas para coger alambre

22-2298-16 16,0 cm/6½"
22-2298-18 18,5 cm/7"

Naht
Suture
Suture
Sutura



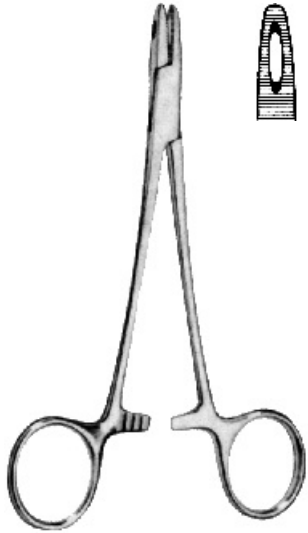

Collier

23-2301 12,5 cm/5"

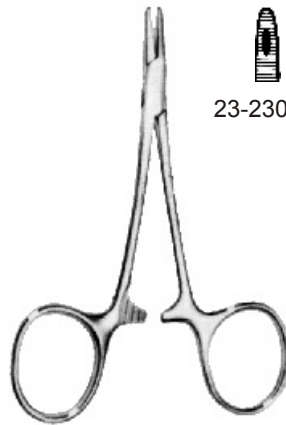

Derf

12,5 cm/5"

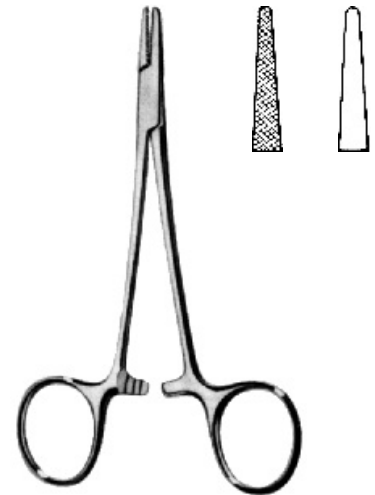

Halsey

23-2310 13,0 cm/5" 23-2311
gerieft glatt
serrated smooth
striée lisse
estriada lisa



Webster

23-2312 13,0 cm/5"
glatt
smooth
lisse
lisa

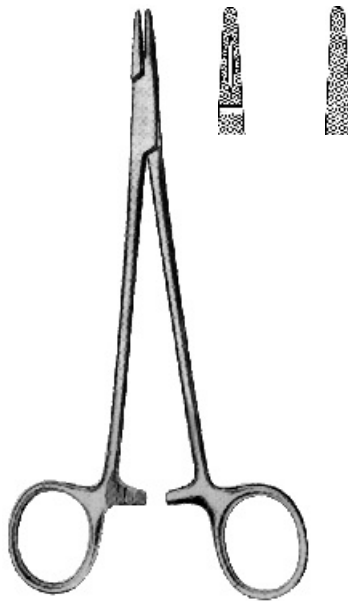

Crile-Wood

23-2314 15,0 cm/6"
mit Rille
with groove
avec cannelure
con ranura

Crile-Wood

23-2315
ohne Rille
without groove
sans cannelure
sin ranura



Brown

23-2318 13,0 cm/5"
23-2319 18,0 cm/7"

23



Sarot

23-2322 18,0 cm/7¼"
23-2324 26,0 cm/10¼"



M.G.H.

23-2329 17,0 cm/6¾"

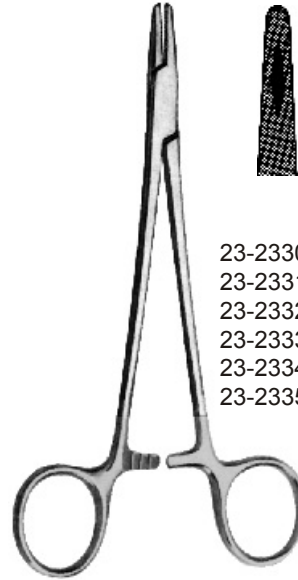

Mayo-Hegar

23-2330	14,0 cm/5½"	
23-2331	16,0 cm/6¼"	23-2341
23-2332	18,0 cm/7¼"	23-2342
23-2333	20,0 cm/8"	23-2343
23-2334	24,0 cm/9½"	23-2344
23-2335	26,0 cm/10¼"	23-2345

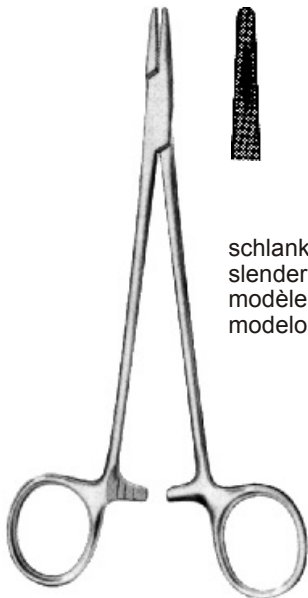

Mayo-Hegar

23-2351 16,0 cm/6¼"
23-2352 18,0 cm/7"
23-2353 20,0 cm/8"

schlankes Modell
slender pattern
modèle gracile
modelo delgado

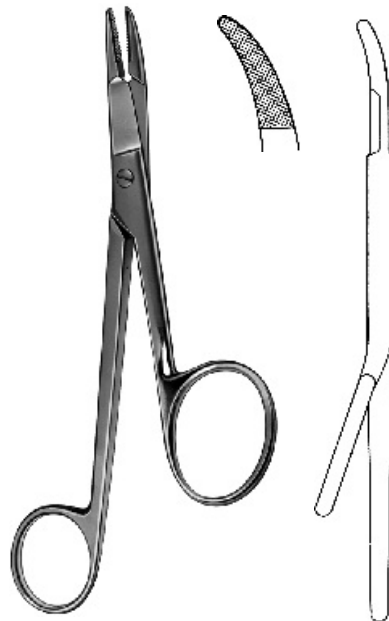

Gillies

23-2354 16,0 cm/6¼"



Hegar-Baumgartner

23-2355 14,0 cm/5½"



für sehr feine Nadeln
for fine needles
pour des aiguilles très fines
para agujas finas

Baby-Olsen-Hegar
11,5 cm/4½"

23-2356-01	23-2356-02
gerieft	glatt
serrated	smooth
striée	lisse
estriada	lisa



Olsen-Hegar

23-2357 14,0 cm/5½"

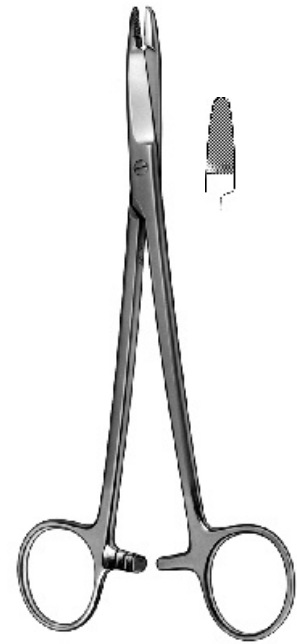

Olsen-Hegar

23-2358 16,0 cm/6¼"

2
3

kräftige Ausführung
heavy pattern
modèle robuste
de fuerte construcción



Olsen-Hegar

23-2357N 14,0 cm/5½"



Olsen-Hegar

23-2358N 17,0 cm/6¼"



Olsen-Hegar

23-2359 18,0 cm/7"

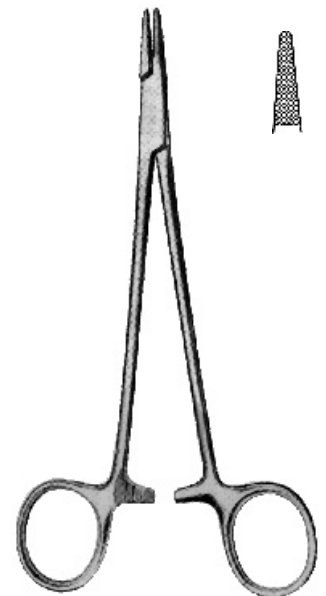

Crile-Wood

23-2360 15,0 cm/6"
23-2361 18,0 cm/7"
23-2362 20,0 cm/8"
23-2363 23,0 cm/9"

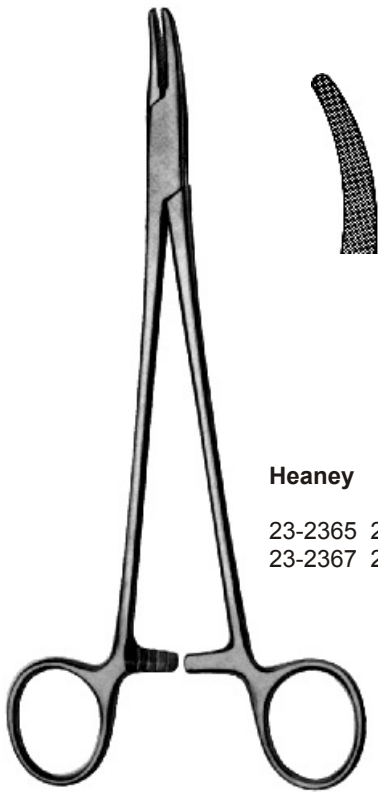

Heaney

23-2365 21,0 cm/8¼"
23-2367 26,0 cm/10¼"

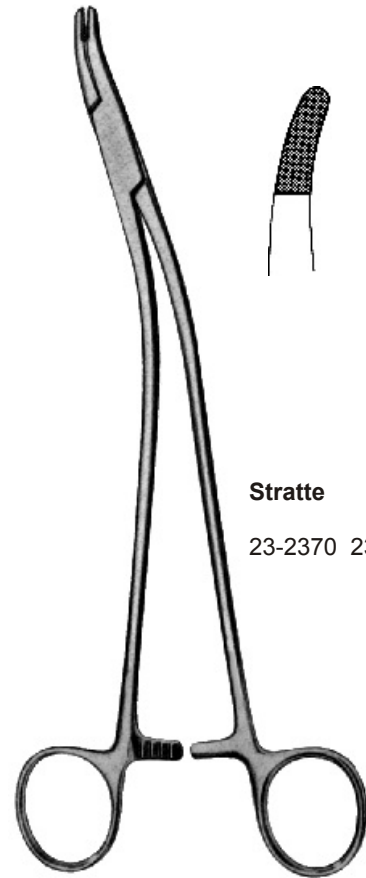

Stratte

23-2370 23,0 cm/9"

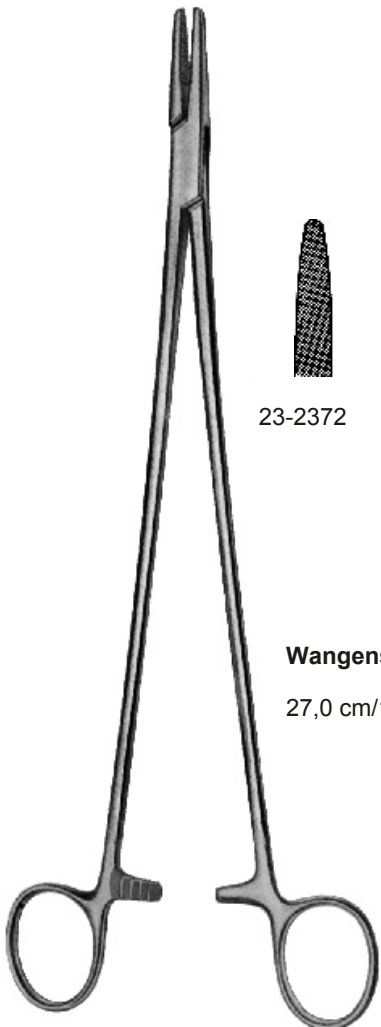

Wangenstein

27,0 cm/10½"



Masson

23-2375
27,0 cm/10½"

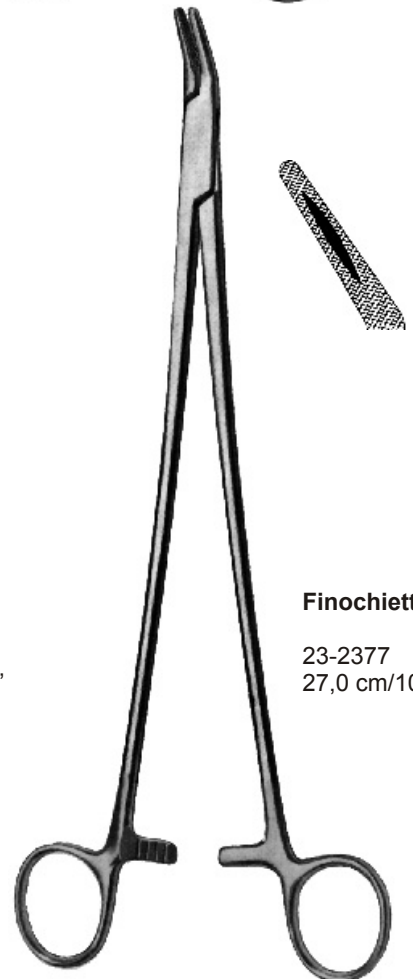

Finochietto

23-2377
27,0 cm/10½"

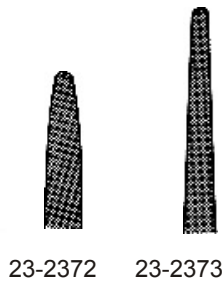

23-2372 23-2373





Crile

23-2382 15,0 cm/6"



Adson

23-2384 18,0 cm/7"

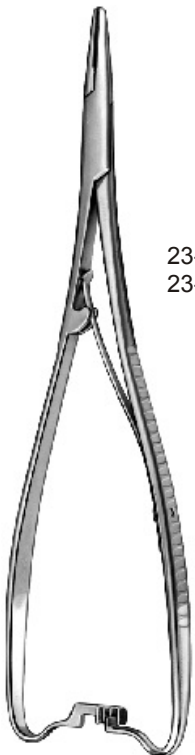

23-2385 17,0 cm/6½"
23-2386 20,0 cm/8" 23-2390
23-2391

Mathieu



23-2387 14,0 cm/2½" 23-2392
23-2388 17,0 cm/6½" 23-2393
23-2389 20,0 cm/8" -23.2394

Mathieu

23-2388K 17,0 cm/6½"
23-2389K 20,0 cm/8"
kräftige Ausführung
heavy pattern
modèle robuste
de fuerte construcción



23-2397 14,0 cm/5½"
23-2398 17,0 cm/6¾"
schlankes Maul
slender jaw
mors étroit
boca fina

23

**mit Sperre, with ratchet
avec crémaillère, con cremallera**



23-2405-14 14,0 cm/5½"
23-2405-18 18,0 cm/7"
23-2405-21 21,0 cm/8¼"
gerade
straight
droite
recta



23-2406-14
23-2406-18
23-2406-21
gebogen
curved
courbe
curva



23-2419-14 14,0 cm/5½"
gerade
straight
droite
recta



23-2420-14
gebogen
curved
courbe
curva



Castroviejo

**ohne Sperre, without ratchet
sans crémaillère, sin cremallera**



23-2407-14 14,0 cm/5½"
gerade
straight
droite
recta



23-2408-14
gebogen
curved
courbe
curva

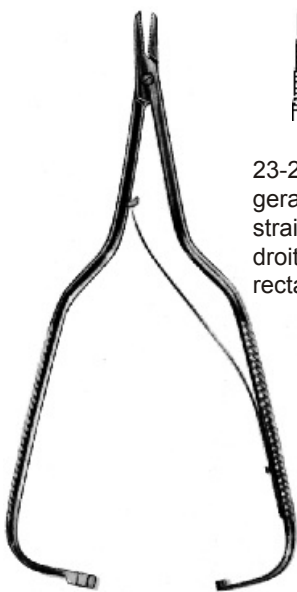

Arruga

16,0 cm/6¼"



23-2401
gerade
straight
droite
recta



23-2402
gebogen
curved
courbe
curva



Kalt

23-2410 14,0 cm/5½"



Barraquer

23-2412 13,5 cm/5"
23-2417 18,0 cm/7"
gerade
straight
droite
recta

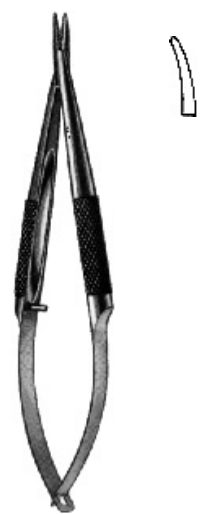





23-2413
23-2418
gebogen
curved
courbe
curva

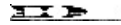

Gewöhnliches Ohr
Regular eye
Chas régulier
Ojo ordinario



Federöhr
Spring eye
Chas à ressort
Ojo de resorte

	gerade	straight	droite	recta
	halbgebogen	half curved	½ courbée	½ curva
	3/8 Kreis	3/8 circle	3/8 cercle	3/8 círculo
	1/2 Kreis	1/2 circle	1/2 cercle	1/2 círculo



Nadeln mit dreikantiger Schneide
Triangular point
Pointe triangulaire
Punta triangular



Runde Nadeln
Round point
Pointe ronde
Punta redonda

Bestell-Nr. + Order-No. + Ref. No. + Ref. No. +	Größen sizes mesures tamaños
-30	000
-20	00
-00	0
-01	1
-02	2
-03	3
-04	4
-05	5
-06	6
-07	7
-08	8
-09	9
-10	10
-11	11
-12	12
-13	13
-14	14
-15	15
-16	16

Verpackungsformen: Päckchen à 12 Stück
Packaging: packets of 12 pieces
Formes d'emballage: paquets de 12 pièces
Formas de embalaje: paquetes de 12 unidades

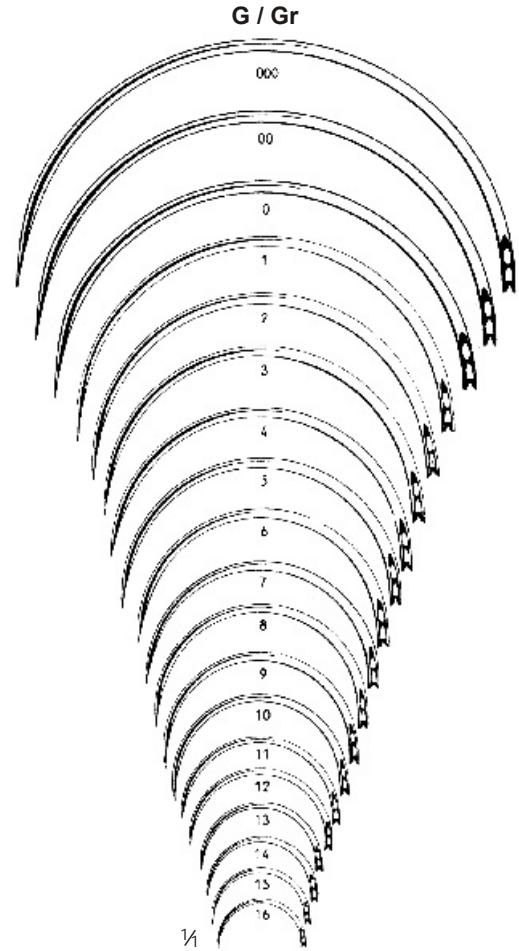
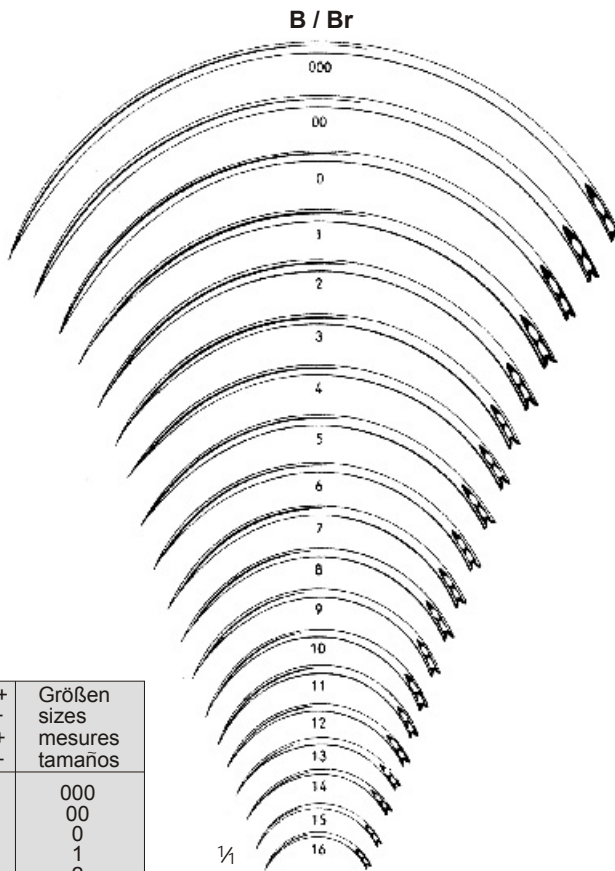

Bestell-Nr. + Order-No. + Ref. No. + Ref. No. +	Größen sizes mesures tamaños
-30	000
-20	00
-00	0
-01	1
-02	2
-03	3
-04	4
-05	5
-06	6
-07	7
-08	8
-09	9
-10	10
-11	11
-12	12
-13	13
-14	14
-15	15
-16	16



Bestell-Nr. Order-No. Ref. No. Ref. No.		Öhr Eye Chas Ojo	Größen Sizes Mesures Tamaños	Profil Profile Profil Perfil	Biegung Curvature Courbure Curvatura
23-2440-30 - 23.2440-16	B		000 - 16	▲	3/8 Kreis; 3/8 circle; 3/8 cercle; 3/8 círculo
23-2441-30 - 23.2441-16	B		000 - 16	▲	3/8 Kreis; 3/8 circle; 3/8 cercle; 3/8 círculo
23-2442-30 - 23.2442-16	Br		000 - 16	●	3/8 Kreis; 3/8 circle; 3/8 cercle; 3/8 círculo
23-2443-30 - 23.2443-16	Br		000 - 16	●	3/8 Kreis; 3/8 circle; 3/8 cercle; 3/8 círculo
23-2446-30 - 23.2446-16	G		000 - 16	▲	1/2 Kreis; 1/2 circle; 1/2 cercle; 1/2 círculo
23-2447-30 - 23.2447-16	G		000 - 16	▲	1/2 Kreis; 1/2 circle; 1/2 cercle; 1/2 círculo
23-2448-30 - 23.2448-16	Gr		000 - 16	●	1/2 Kreis; 1/2 circle; 1/2 cercle; 1/2 círculo
23-2449-30 - 23.2449-16	Gr		000 - 16	●	1/2 Kreis; 1/2 circle; 1/2 cercle; 1/2 círculo

Ga / Gar

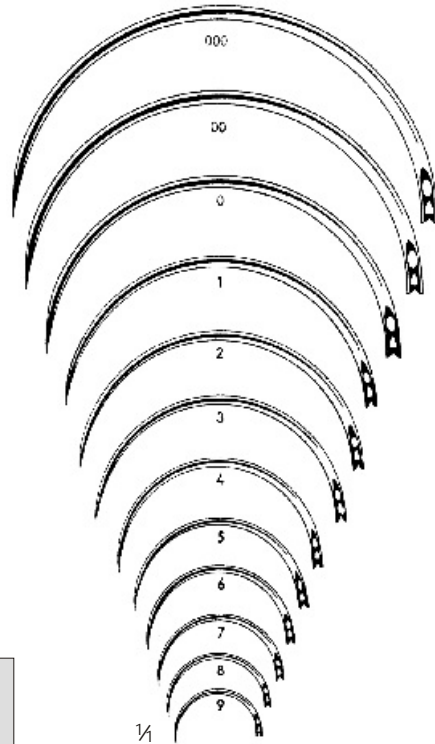

Keith

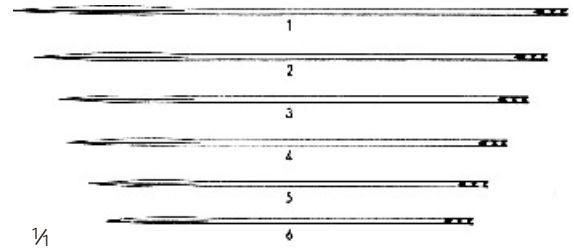

Bestell-Nr. Order-No. Ref. No. Ref. No.	+ + + +	Größen sizes mesures tamaños
-30		000
-20		00
-00		0
-01		1
-02		2
-03		3
-04		4
-05		5
-06		6
-07		7
-08		8
-09		9
-10		10
-11		11
-12		12
-13		13
-14		14
-15		15
-16		16

2
3

Bestell-Nr. Order-No. Ref. No. Ref. No.		Öhr Eye Chas Ojo	Größen Sizes Mesures Tamaños	Profil Profile Profil Perfil	Biegung Curvature Courbure Curvatura
23-2451-30 - 23.2451-09	Ga		000 - 9	▲	½ Kreis; ½ circle; ½ cercle; ½ círculo
23-2452-30 - 23.2452-09	Ga		000 - 9	▲	½ Kreis; ½ circle; ½ cercle; ½ círculo
23-2453-30 - 23.2453-09	Gar		000 - 9	●	½ Kreis; ½ circle; ½ cercle; ½ círculo
23-2454-30 - 23.2454-09	Gar		000 - 9	●	½ Kreis; ½ circle; ½ cercle; ½ círculo
23-2457-01 - 23.2457-06	Keith		1 - 6	▲	gerade, straight, droite, recta
23-2458-01 - 23.2458-06	Keith		1 - 6	▲	gerade, straight, droite, recta
23-2459-01 - 23.2459-06	Keith		1 - 6	●	gerade, straight, droite, recta
23-2460-01 - 23.2460-06	Keith		1 - 6	●	gerade, straight, droite, recta

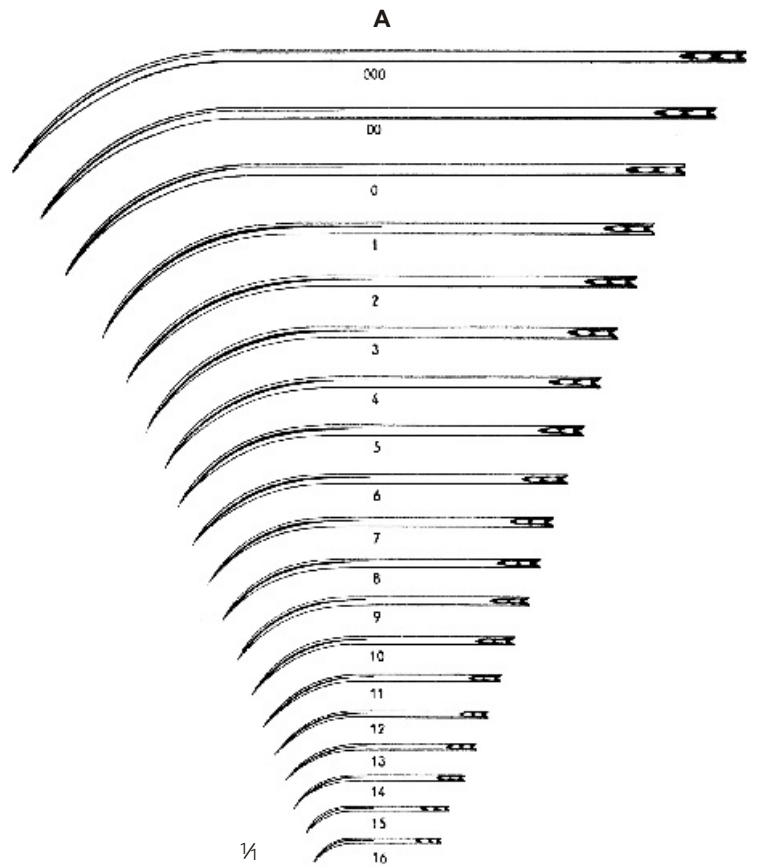
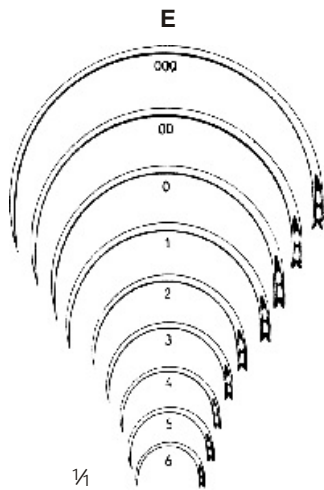

Bestell-Nr. + Order-No. + Ref. No. + Ref. No. +	Größen sizes mesures tamaños
-30	000
-20	00
-00	0
-01	1
-02	2
-03	3
-04	4
-05	5
-06	6
-07	7
-08	8
-09	9
-10	10
-11	11
-12	12
-13	13
-14	14
-15	15
-16	16

Bestell-Nr. Order-No. Ref. No. Ref. No.		Öhr Eye Chas Ojo	Größen Sizes Mesures Tamaños	Profil Profile Profil Perfil	Biegung Curvature Courbure Curvatura
23-2463-30 - 23.2463-06	E		000 - 6	●	½ Kreis; ½ circle; ½ cercle; ½ círculo
23-2464-30 - 23.2464-06	E		000 - 6	●	½ Kreis; ½ circle; ½ cercle; ½ círculo

23-2466-30 - 23.2466-16	A		000 - 16	▲	halb-gebogen, half-curved, ½ courbée, ½ curva
23-2467-30 - 23.2467-16	A		000 - 16	▲	halb-gebogen, half-curved, ½ courbée, ½ curva

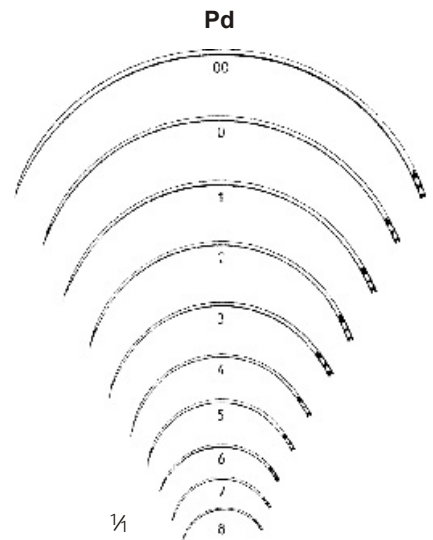
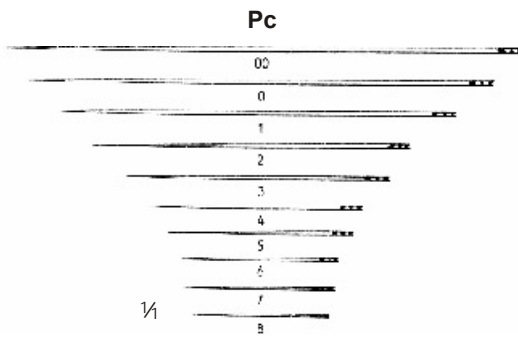
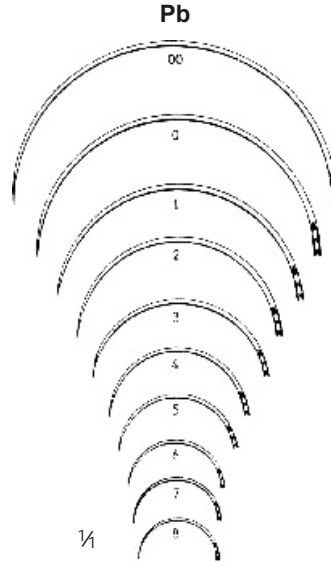
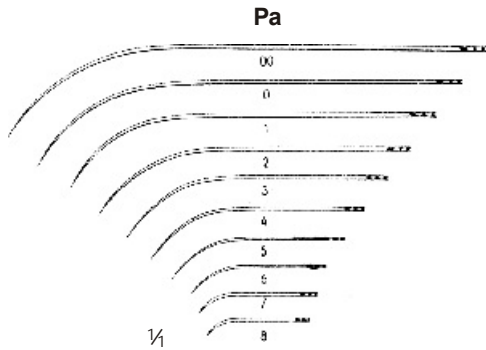

Bestell-Nr. + Order-No. + Ref. No. + Ref. No. +	Größen sizes mesures tamaños
-30	000
-20	00
-00	0
-01	1
-02	2
-03	3
-04	4
-05	5
-06	6
-07	7
-08	8
-09	9
-10	10
-11	11
-12	12
-13	13
-14	14
-15	15
-16	16

23

Bestell-Nr. Order-No. Ref. No. Ref. No.		Öhr Eye Chas Ojo	Größen Sizes Mesures Tamaños	Profil Profile Profil Perfil	Biegung Curvature Courbure Curvatura
23-2470-20 - 23.2470-08	Pa		00 - 8	●	halb-gebogen, half-curved, ½ courbée, ½ curva
23-2471-20 - 23.2471-08	Pa		00 - 8	●	halb-gebogen, half-curved, ½ courbée, ½ curva
23-2472-20 - 23.2472-08	Pb		00 - 8	●	½ Kreis; ½ circle; ½ cercle; ½ círculo
23-2473-20 - 23.2473-08	Pb		00 - 8	●	½ Kreis; ½ circle; ½ cercle; ½ círculo
23-2474-20 - 23.2474-08	Pc		00 - 8	●	gerade, straight, droite, recta
23-2475-20 - 23.2475-08	Pc		00 - 8	●	gerade, straight, droite, recta
23-2476-20 - 23.2476-08	Pd		00 - 8	●	⅜ Kreis; ⅜ circle; ⅜ cercle; ⅜ círculo
23-2477-20 - 23.2477-08	Pd		00 - 8	●	⅜ Kreis; ⅜ circle; ⅜ cercle; ⅜ círculo

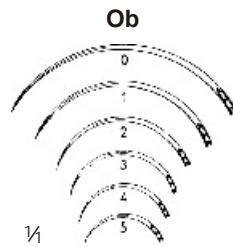
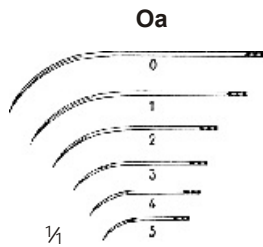

Bestell-Nr. + Order-No. + Ref. No. + Ref. No. +	Größen sizes mesures tamaños
-30	000
-20	00
-00	0
-01	1
-02	2
-03	3
-04	4
-05	5
-06	6
-07	7
-08	8
-09	9
-10	10
-11	11
-12	12
-13	13
-14	14
-15	15
-16	16

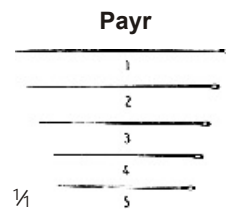
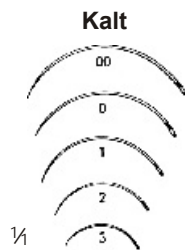

Bestell-Nr. Order-No. Ref. No. Ref. No.		Öhr Eye Chas Ojo	Größen Sizes Mesures Tamaños	Profil Profile Profil Perfil	Biegung Curvature Courbure Curvatura
23-2480-00 - 23.2480-05	Oa		0 - 5	▲	halb-gebogen, half-curved, 1/2 courbée, 1/2 curva
23-2481-00 - 23.2481-05	Oa		0 - 5	▲	halb-gebogen, half-curved, 1/2 courbée, 1/2 curva
23-2482-00 - 23.2482-05	Ob		0 - 5	▲	3/8 Kreis; 3/8 circle; 3/8 cercle; 3/8 círculo
23-2483-00 - 23.2483-05	Ob		0 - 5	▲	3/8 Kreis; 3/8 circle; 3/8 cercle; 3/8 círculo
23-2484-00 - 23.2484-05	Og		0 - 5	▲	1/2 Kreis; 1/2 circle; 1/2 cercle; 1/2 círculo
23-2485-00 - 23.2485-05	Og		0 - 5	▲	1/2 Kreis; 1/2 circle; 1/2 cercle; 1/2 círculo
23-2486-20 - 23.2486-03	Kalt		00-3	●	3/8 Kreis; 3/8 circle; 3/8 cercle; 3/8 círculo
23-2487-01 - 23.2487-05	Payr		1 - 5	●	gerade, straight, droite, recta
23-2488-20 - 23.2488-03	Payr		00 - 3	●	1/2 Kreis; 1/2 circle; 1/2 cercle; 1/2 círculo

Ferguson

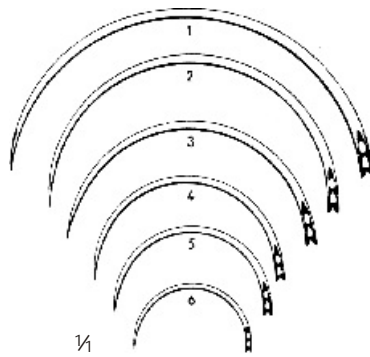

Mayo

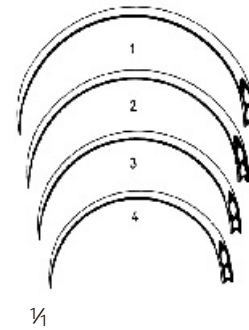

Bestell-Nr. + Order-No. + Ref. No. + Ref. No. +	Größen sizes mesures tamaños
-30	000
-20	00
-00	0
-01	1
-02	2
-03	3
-04	4
-05	5
-06	6
-07	7
-08	8
-09	9
-10	10
-11	11
-12	12
-13	13
-14	14
-15	15
-16	16

23

Bestell-Nr. Order-No. Ref. No. Ref. No.		Öhr Eye Chas Ojo	Größen Sizes Mesures Tamaños	Profil Profile Profil Perfil	Biegung Curvature Courbure Curvatura
23-2490-01 - 23-2490-06	Ferguson		1 - 6	●	½ Kreis; ½ circle; ½ cercle; ½ círculo
23-2491-01 - 23-2491-06	Ferguson		1 - 6	●	½ Kreis; ½ circle; ½ cercle; ½ círculo
23-2492-01 - 23-2492-04	Mayo		1 - 4	●	½ Kreis; ½ circle; ½ cercle; ½ círculo
23-2493-01 - 23-2493-04	Mayo		1 - 4	●	½ Kreis; ½ circle; ½ cercle; ½ círculo



Michel (1x2)
23-2500 12,0 cm/4³/₄"



Michel
23-2505 12,0 cm/4³/₄"



Hegenbarth
23-2508 12,5 cm/5"



Wachenfeldt
23-2509 12,5 cm/5"



Michel
23-2511 12,0 cm/4³/₄"

Wundklammer-Zangen
Clip Applying Forceps
Pinces pour agrafes
Pinzas para agrafes



Collin
23-2515 13,0 cm/5¹/₄"



Standard
23-2518 165 x 90 x 28 mm

23

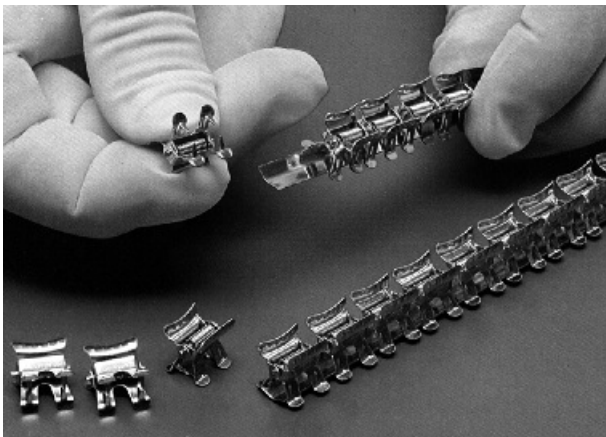

Wundsparklammern
23-2516

Mindestabnahme: 50 Stück
Minimum quantity: 50 each
Quantité minimum: 50 pièces
Cantidad mínimo: 50 piezas

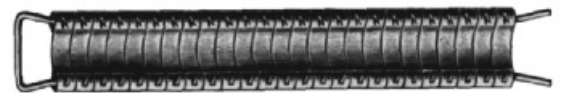

1 Pack = 100 Stück
1 Package = 100 each
1 Paquet = 100 pièces
1 Paquete = 100 piezas

Michel

23-2519-01	7,5 x 1,75 mm
23-2519-02	11 x 2 mm
23-2519-03	12 x 3 mm
23-2519-04	14 x 3 mm
23-2519-05	16 x 3 mm
23-2519-06	18 x 3 mm
23-2519-07	20 x 3 mm
23-2519-08	22 x 3 mm

Mindestabnahme: 10 Pack
Minimum quantity: 10 packages
Quantité minimum: 10 paquets
Cantidad mínimo: 10 paquetes

links gebogen
für die rechte
Hand

curved to the left,
for the right
handa

courbe à gauche
pour la main
droite

curva a la izquierda,
para la mano
derecha

rechts gebogen
für die linke
Hand

curved to the right,
for the left
hand

courbe à droite
pour la main
gauche

curva a la derecha,
para la mano
izquierda

links gebogen
für die rechte
Hand

curved to the left,
for the right
hand

courbe à gauche
pour la main
droite

curva a la izquierda,
para la mano
derecha

rechts gebogen
für die linke
Hand

curved to the right,
for the left
hand

courbe à droite
pour la main
gauche

curva a la derecha,
para la mano
izquierda

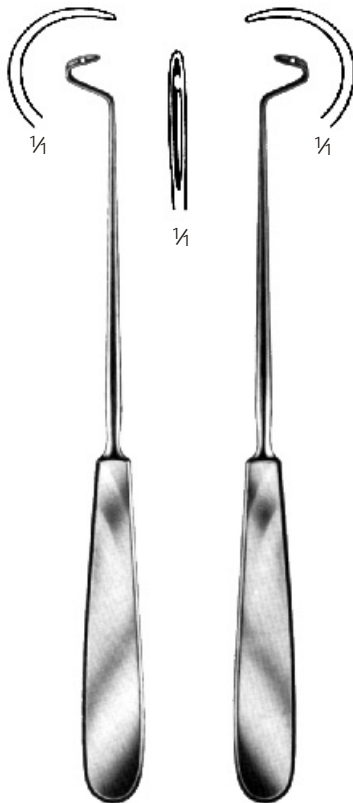

Deschamps

23-2530-20
20,0 cm/8"
stumpf
blunt
mousse
roma

Deschamps

23-2531-20
20,0 cm/8"
stumpf
blunt
mousse
roma

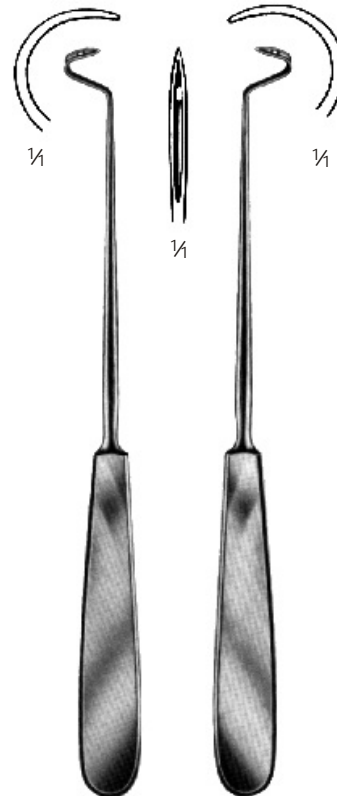

Deschamps

23-2532-20
20,0 cm/8"
scharf
sharp
pointue
aguda

Deschamps

23-2533-20
20,0 cm/8"
scharf
sharp
pointue
aguda

links gebogen
für die rechte
Hand

curved to the left,
for the right
hand

courbe à gauche
pour la main
droite

curva a la izquierda,
para la mano
derecha

rechts gebogen
für die linke
Hand

curved to the right,
for the left
hand

courbe à droite
pour la main
gauche

curva a la derecha,
para la mano
izquierda

links gebogen
für die rechte
Hand

curved to the left,
for the right
hand

courbe à gauche
pour la main
droite

curva a la izquierda,
para la mano
derecha

rechts gebogen
für die linke
Hand

curved to the right,
for the left
hand

courbe à droite
pour la main
gauche

curva a la derecha,
para la mano
izquierda

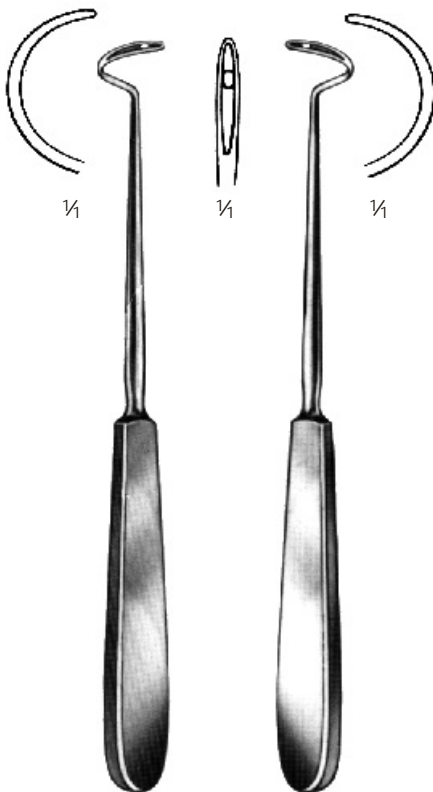

Deschamps

23-2534-20
20,0 cm/8"
stumpf
blunt
mousse
roma

Deschamps

23-2535-20
20,0 cm/8"
stumpf
blunt
mousse
roma

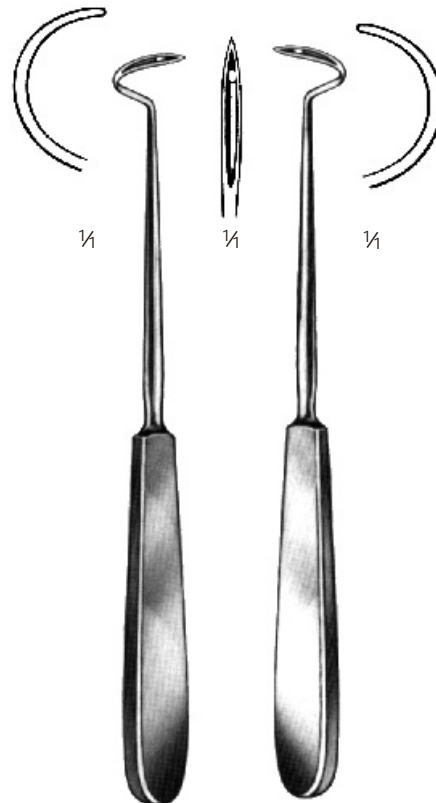

Deschamps

23-2536-20
20,0 cm/8"
scharf
sharp
pointue
aguda

Deschamps

23-2537-20
20,0 cm/8"
scharf
sharp
pointue
aguda

links gebogen
für die rechte
Hand

curved to the left,
for the right
hand

courbe à gauche
pour la main
droite

curva a la izquierda,
para la mano
derecha

rechts gebogen
für die linke
Hand

curved to the right,
for the left
hand

courbe à droite
pour la main
gauche

curva a la derecha,
para la mano
izquierda

links gebogen
für die rechte
Hand

curved to the left,
for the right
hand

courbe à gauche
pour la main
droite

curva a la izquierda,
para la mano
derecha

rechts gebogen
für die linke
Hand

curved to the right,
for the left
hand

courbe à droite
pour la main
gauche

curva a la derecha,
para la mano
izquierda

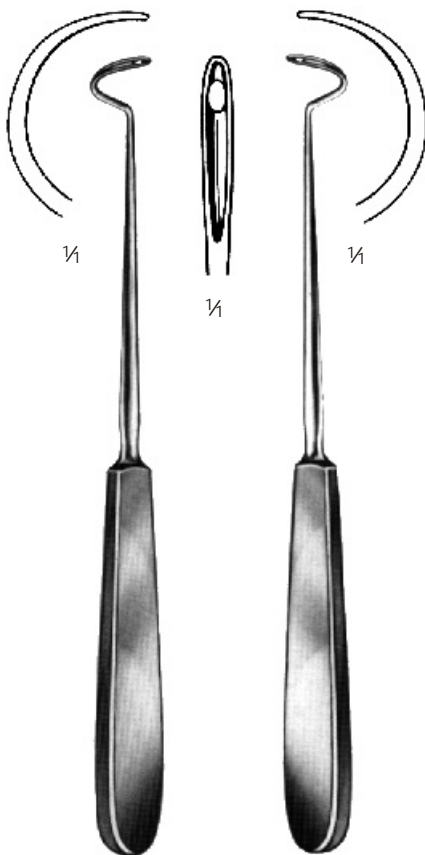

Deschamps

23-2538-21
21,0 cm/8¼"
stumpf
blunt
mousse
roma

Deschamps

23-2539-21
21,0 cm/8¼"
stumpf
blunt
mousse
roma

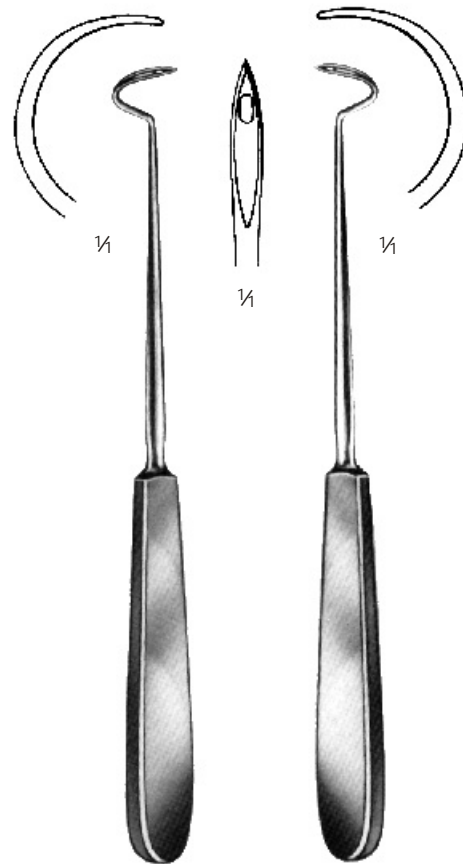

Deschamps

23-2540-21
21,0 cm/8¼"
scharf
sharp
pointue
aguda

Deschamps

23-2541-21
21,0 cm/8¼"
scharf
sharp
pointue
aguda

links gebogen
für die rechte
Hand

curved to the left,
for the right
hand

courbe à gauche
pour la main
droite

curva a la izquierda,
para la mano
derecha

rechts gebogen
für die linke
Hand

curved to the right,
for the left
hand

courbe à droite
pour la main
gauche

curva a la derecha,
para la mano
izquierda

links gebogen
für die rechte
Hand

curved to the left,
for the right
hand

courbe à gauche
pour la main
droite

curva a la izquierda,
para la mano
derecha

rechts gebogen
für die linke
Hand

curved to the right,
for the left
hand

courbe à droite
pour la main
gauche

curva a la derecha,
para la mano
izquierda

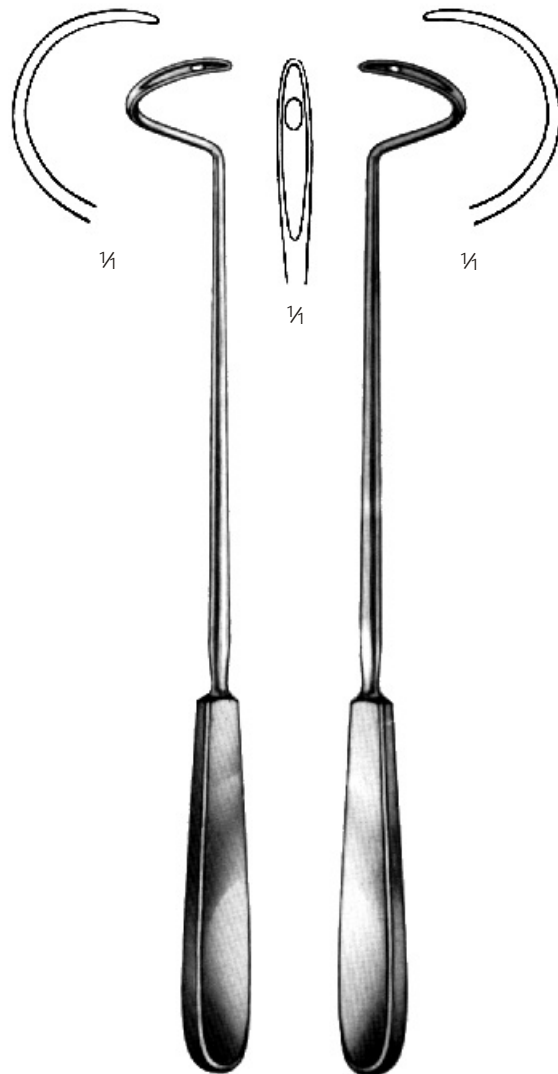
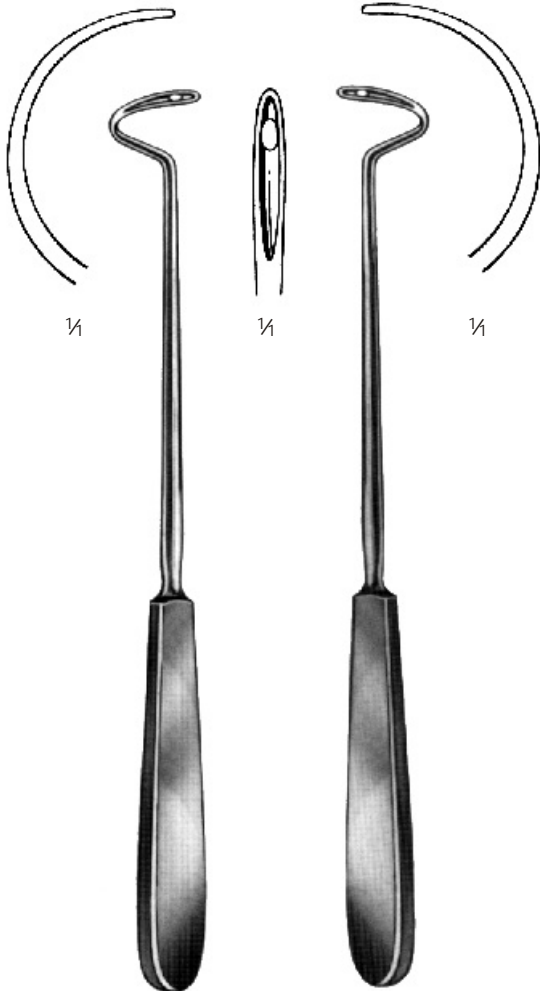

Deschamps

23-2542-24
24,0 cm/9½"
stumpf
blunt
mousse
roma

Deschamps

23-2543-24
24,0 cm/9½"
stumpf
blunt
mousse
roma

Deschamps

23-2544-27
27,0 cm/10½"
stumpf
blunt
mousse
roma

Deschamps

23-2545-27
27,0 cm/10½"
stumpf
blunt
mousse
roma

23

links gebogen
für die rechte
Hand

curved to the left,
for the right
hand

courbe à gauche
pour la main
droite

curva a la izquierda,
para la mano
derecha

rechts gebogen
für die linke
Hand

curved to the right,
for the left
hand

courbe à droite
pour la main
gauche

curva a la derecha,
para la mano
izquierda

links gebogen
für die rechte
Hand

curved to the left,
for the right
hand

courbe à gauche
pour la main
droite

curva a la izquierda,
para la mano
derecha

rechts gebogen
für die linke
Hand

curved to the right,
for the left
hand

courbe à droite
pour la main
gauche

curva a la derecha,
para la mano
izquierda

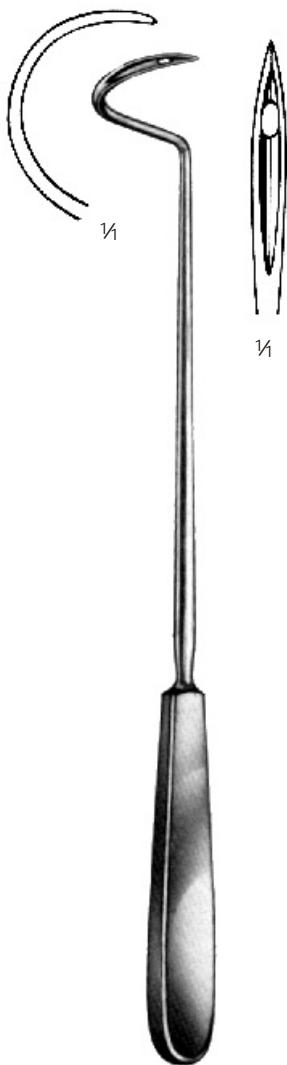

Deschamps

23-2546-27
27,0 cm/10½"
scharf
sharp
pointue
aguda

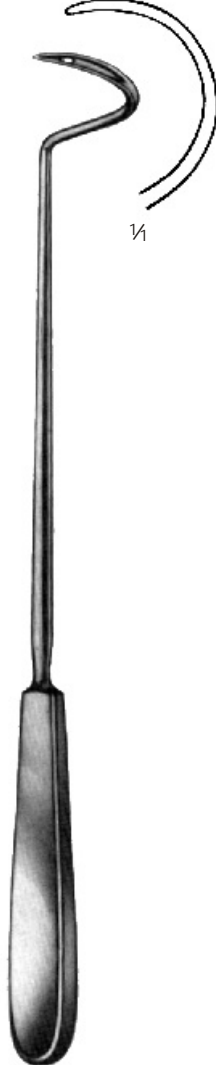

Deschamps

23-2547-27
27,0 cm/10½"
scharf
sharp
pointue
aguda



Deschamps

23-2548-28
28,0 cm/11"
stumpf
blunt
mousse
roma

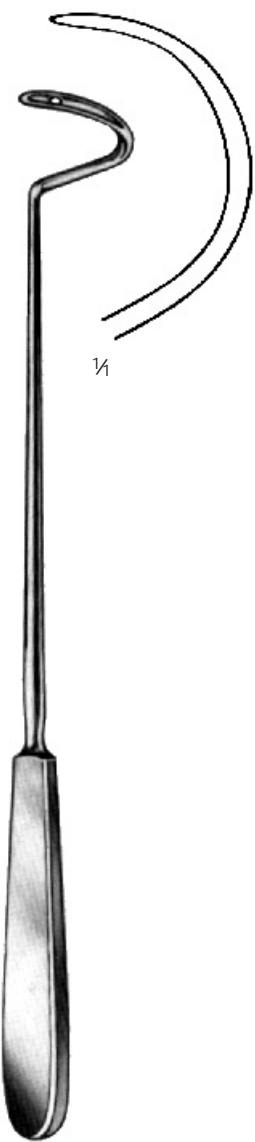

Deschamps

23-2549-28
28,0 cm/11"
stumpf
blunt
mousse
roma

links gebogen
für die rechte
Hand

curved to the left,
for the right
hand

courbe à gauche
pour la main
droite

curva a la izquierda,
para la mano
derecha

rechts gebogen
für die linke
Hand

curved to the right,
for the left
hand

courbe à droite
pour la main
gauche

curva a la derecha,
para la mano
izquierda



Kronecker

23-2550-01
13,0 cm/5"

Kronecker

23-2550-02
13,0 cm/5"

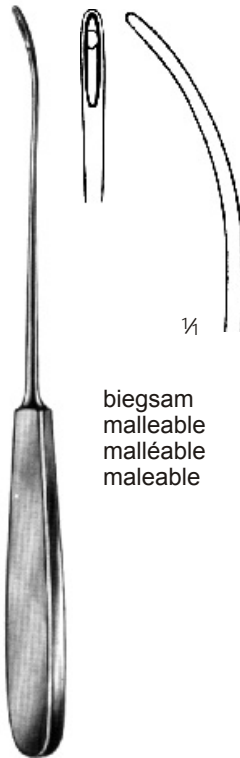

biegsam
malleable
malléable
maleable

23-2551-01
20,0 cm/8"

Cooper

23-2551-02
19,0 cm/7½"



biegsam
malleable
malléable
maleable

Schmieden-Dick

23-2552-32
32,0 cm/12½"



Schmieden

23-2553-21
21,0 cm/8¼"



Hessberg

23-2554-15
 15,0 cm/6"



Woodruff
 13,0 cm/5"

23-2555-01	23-2555-02
rechts	links
right	left
à droite	à gauche
derecha	izquierda

links gebogen
 für die rechte
 Hand

rechts gebogen
 für die linke
 Hand

curved to the left,
 for the right
 hand

curved to the right,
 for the left
 hand

courbe à gauche
 pour la main
 droite

courbe à droite
 pour la main
 gauche

curva a la izquierda,
 para la mano
 derecha

curva a la derecha,
 para la mano
 izquierda



De la Roza
 12,0 cm/4¾"

23-2556-01
 23-2556-01



23-2556-02
 23-2556-02



Narath

23-2557-22
 22,0 cm/9"



¼
 ¼



Fig. 1
23-2560-01



Fig. 2
23-2560-02



Fig. 3
23-2560-03

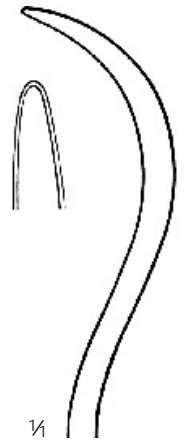
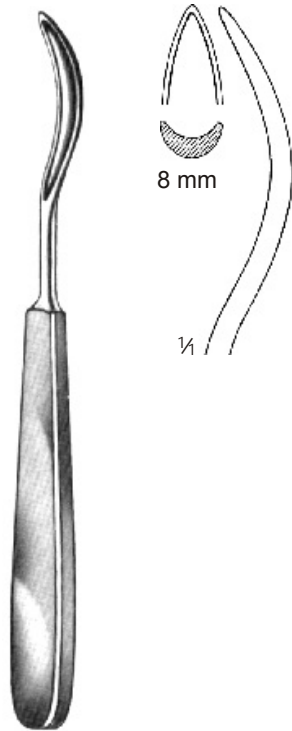

Fig. 4
23-2560-04

Brunner
30,0 cm/12"

Brunner
30,0 cm/12"

23



Schmieden

23-2561-01
19,0 cm/7½"

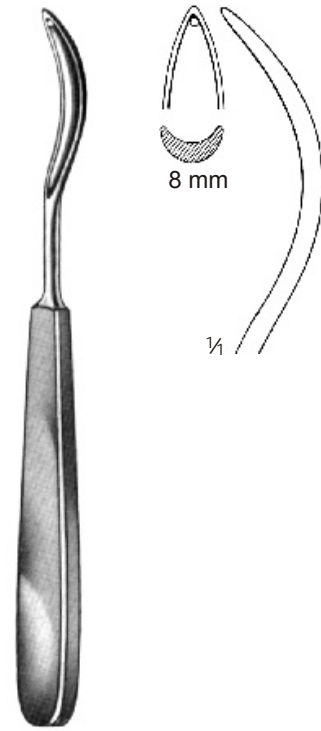

Schmieden-Payr

23-2561-02
19,0 cm/7½"

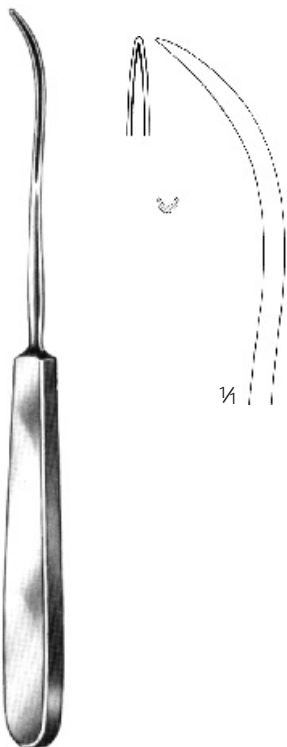

König

23-2562-01
19,5 cm/7¾"

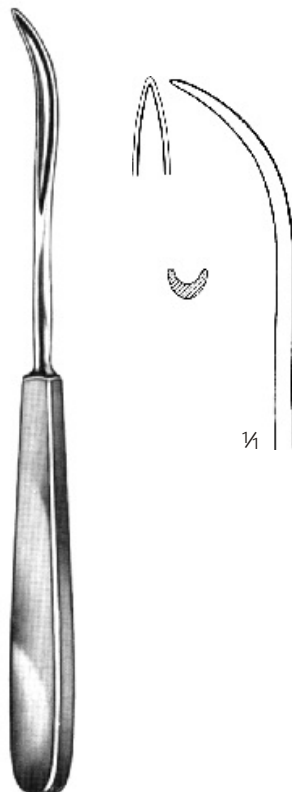

König

23-2562-02
19,5 cm/7¾"

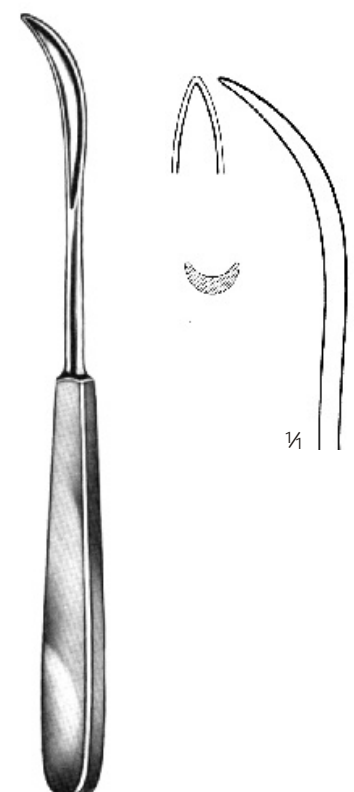

König

23-2562-03
20,0 cm/8"





Payr

Fig. 1
23-2563-01
22,0 cm/8³/₄"

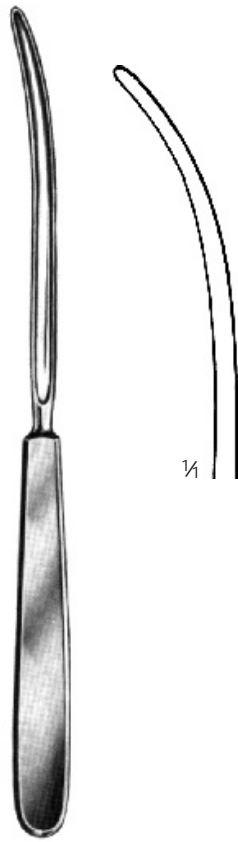

Payr

Fig. 2
23-2563-02
22,0 cm/8³/₄"

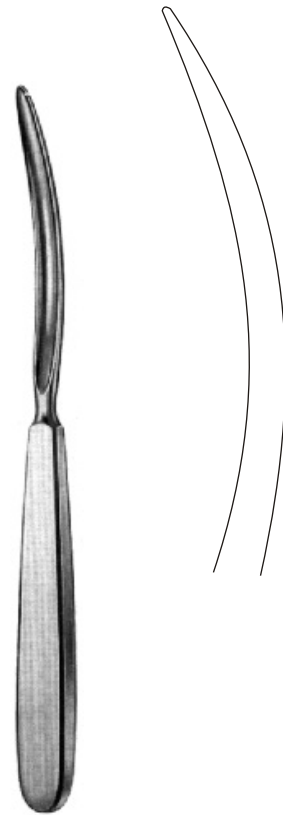

23-2564-25
19,5 cm/7³/₄"



Kocher



15,0 cm/6"

23-2565-01



23-2565-02



17,0 cm/7"

23-2565-03



Brunner-Ferrozell

23-2566-18 18,0 cm/7"
23-2566-27 27,0 cm/10¹/₂"



Reverdin
14,0 cm/5½"



Fig. 1
23-2570-01



Fig. 2
23-2570-02



Fig. 3
23-2570-03



Fig. 4
23-2570-04



Reverdin
19,5 cm/7¾"



Fig. 1
23-2571-01



Fig. 2
23-2571-02



Fig. 3
23-2571-03



Fig. 4
23-2571-04



23



Reverdin
22,5 cm/8³/₄"



Fig. 1
23-2572-01



Fig. 2
23-2572-02



Fig. 3
23-2572-03



Fig. 4
23-2572-04

Impfen und Punktion
Vaccination and Puncture
Vaccination et ponction
Vacunación y punción



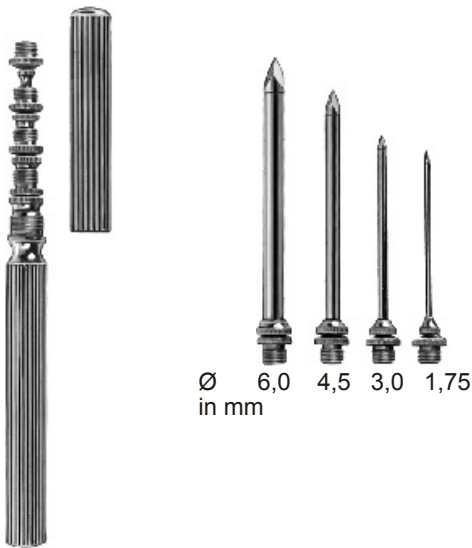

Universal

24-2603
mit Satz 3-teilig (4,5/3,0/1,75mm)
with set of 3 pieces(4,5/3,0/1,75mm)
avec jeu de 3 pièces(4,5/3,0/1,75mm)
con juego de 3 piezas(4,5/3,0/1,75mm)

24-2604
mit Satz 4-teilig
with set of 4 pieces
avec jeu de 4 pièces
con juego de 4 piezas

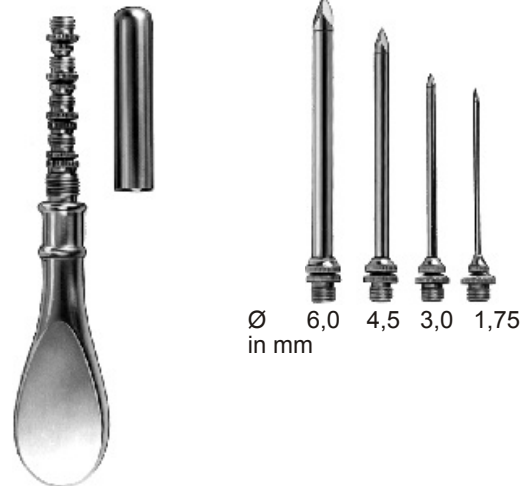

Universal

24-2606
mit Satz 3-teilig (4,5/3,0/1,75mm)
with set of 3 pieces(4,5/3,0/1,75mm)
avec jeu de 3 pièces(4,5/3,0/1,75mm)
con juego de 3 piezas(4,5/3,0/1,75mm)

24-2607
mit Satz 4-teilig
with set of 4 pieces
avec jeu de 4 pièces
con juego de 4 piezas

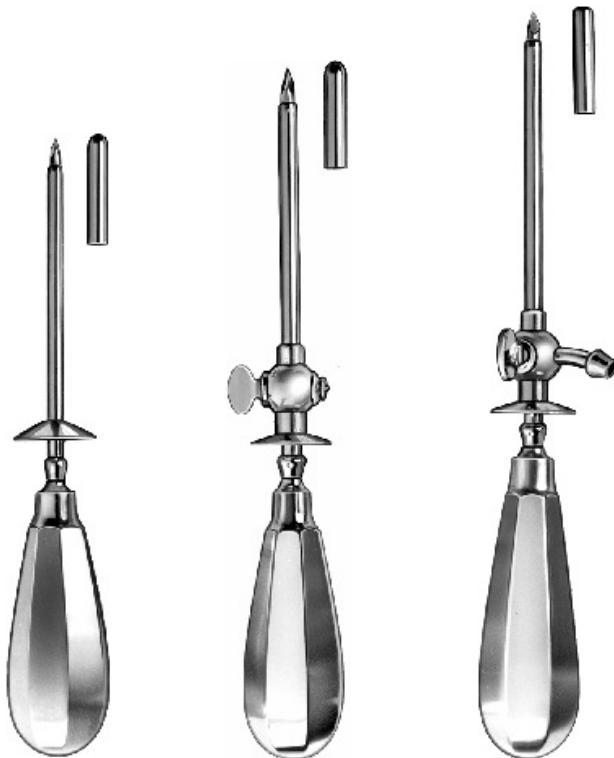

Ø mm	Standard 11,0 cm/4½"	Standard 12,0 cm/4¾"	Standard 12,0 cm/4¾"
3,0	24-2610	24-2620	24-2630
3,5	24-2611	24-2621	24-2631
4,0	24-2612	24-2622	24-2632
4,5	24-2613	24-2623	24-2633
5,0	24-2614	24-2624	24-2634
5,5	24-2615	24-2625	24-2635
6,0	24-2616	24-2626	24-2636

24



Nelson
21,0 cm/8½"



24-2637-07



24-2637-09



24-2637-11



24-2637-12

Ø außen, Ø outside 7,5 mm
Ø à l'extérieur, Ø al exterior

Ø innen, Ø inside 6,0 mm
Ø à l'intérieur, Ø al interior

9,5 mm

11,0 mm

12,5 mm

8,0 mm

9,5 mm

11,0 mm

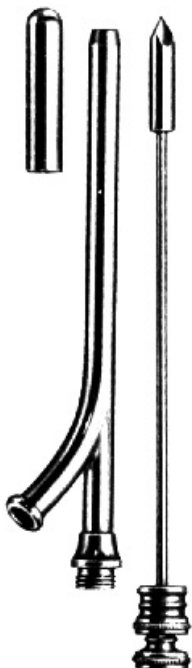

Ochsner
14,5 cm/5½"

Ø außen
Ø outside
Ø à l'extérieur
Ø al exterior

Charr. mm

24-2640-10	10	3,0
24-2640-12	12	4,0
24-2640-14	14	4,5
24-2640-16	16	5,5
24-2640-18	18	6,0
24-2640-20	20	6,5
24-2640-22	22	7,5
24-2640-24	24	8,0
24-2640-26	26	8,5
24-2640-28	28	9,0

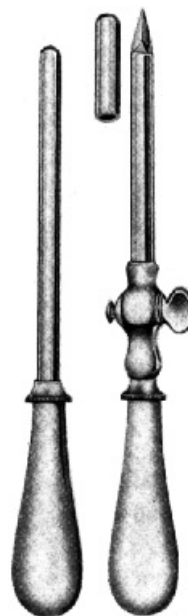

Buelau
24,0 cm/9½"

Ø außen Ø innen
Ø outside Ø inside
Ø à l'extérieur Ø à l'intérieur
Ø al exterior Ø al interior

24-2641-08

8,0 mm

6,5 mm

24-2641-10

10,0 mm

8,5 mm



2,0 mmØ



Landau

24-2642-01

2,0 mmØ



Landau

24-2642-02

13,5 mmØ

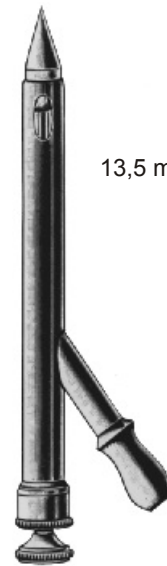

Péan

24-2644

1,75 mmØ



Lichtwitz

24-2651

2,0 mmØ



Lichtwitz

24-2652



Pierce

24-2655 3,0 mmØ
24-2656 4,0 mmØ
24-2657 5,0 mmØ

24



Krause

24-2660



Coakley

24-2661



Führungsnadel, gerade
Guide Needle, straight
Aiguille d'introduction, droite
Aguja de guía, recta

Führungsnadel, gebogen
Guide Needle, curved
Aiguille d'introduction, courbe
Aguja de guía, curva

Führungsnadel, mit Lanzettenspitze
Guide Needle, with lancet point
Aiguille d'introduction, à pointe lancéolaire
Aguja de guía, con punta lanceolar

Charr.

8	24-2662-08
10	24-2662-10
12	24-2662-12
14	24-2662-14
16	24-2662-16
18	24-2662-18

Charr.

8	24-2663-08
10	24-2663-10
12	24-2663-12
14	24-2663-14
16	24-2663-16
18	24-2663-18

Charr.

8	24-2664-08
10	24-2664-10
12	24-2664-12
14	24-2664-14
16	24-2664-16
18	24-2664-18



Adson
21,0 cm/8½"

	Charr.	Ø mm
24-2668-12	12	4,0
24-2668-15	15	5,0



Wullstein
14,0 cm/5½"

0,4 mmØ

0,6 mmØ

0,8 mmØ



24-2669-04

24-2669-06

24-2669-08

24-2669-01

Mikro-Absaugrohr allein, mit Luer-Bohrung
Micro suction tube only, with Luer perforation
Micro tube d'aspiration seule, avec perforation Luer
Micro tubo de aspiración suelto, con perforación de Luer

24-2669-00

Satz komplett 24-2669-01 - 24-2669-08
Set complete 24-669-01 - 24-2669-08
Jeu complet 24-669-01 - 24-2669-08
Juego completo 24-2669-01 - 24-2669-08



Arbeitslänge
Working length
Longueur utile
Largo útil
12,5 cm/5"

Frazier
18,0 cm/7"

Charr.

6	24-2670-06
7	24-2670-07
8	24-2670-08
9	24-2670-09
10	24-2670-10
11	24-2670-11
12	24-2670-12
15	24-2670-15





Frazier
18,0 cm/7"

	Charr.	Ø mm
24-2671-09	9	3,0
24-2671-15	15	5,0



Fergusson
18,0 cm/7"

	Charr.	Ø mm
24-2672-00	12	4,0

24
2



Fergusson
18,0 cm/7"

	Charr.	Ø mm
24-2672-06	6	2,0
24-2672-07	7	2,3
24-2672-08	8	2,5
24-2672-09	9	3,0
24-2672-10	10	3,3
24-2672-11	11	3,5
24-2672-12	12	4,0
24-2672-15	15	5,0



Plester
19,5 cm/7¾"

	Charr.	Ø mm
24-2673-05	5	1,5
24-2673-06	6	2,0
24-2673-07	7	2,3
24-2673-08	8	2,5
24-2673-09	9	3,0
24-2673-10	10	3,5



Punktionskanüle
 Puncture Cannula
 Canule à ponction
 Cánula de punción

Klima-Rosegger
 1,80 x 35 mm

24-2674

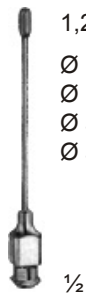

1,2 mm
 Ø innen
 Ø inside
 Ø à l'intérieur
 Ø al interior

Mock

24-2675-03 3,0 cm/1¼"
 24-2675-06 6,0 cm/2½"



Biopsiekanüle
 Biopsy Needle
 Aiguille à biopsie
 Aguja para biopsía

24-2676-01	1,00 x 35 mm
24-2676-02	1,00 x 70 mm
24-2676-03	1,20 x 70 mm
24-2676-04	1,20 x 100 mm
24-2676-05	1,40 x 70 mm
24-2676-06	1,40 x 100 mm
24-2676-07	1,60 x 70 mm
24-2676-08	1,80 x 100 mm

Menghini



Biopsiekanüle
 Biopsy Needle
 Aiguille à biopsie
 Aguja para biopsía

24-2677-14	1,40 x 168 mm
24-2677-18	1,80 x 168 mm

Menghini



24-2678-01	2,00 x 80 mm
24-2678-02	2,00 x 100 mm
24-2678-03	2,00 x 120 mm

Verres

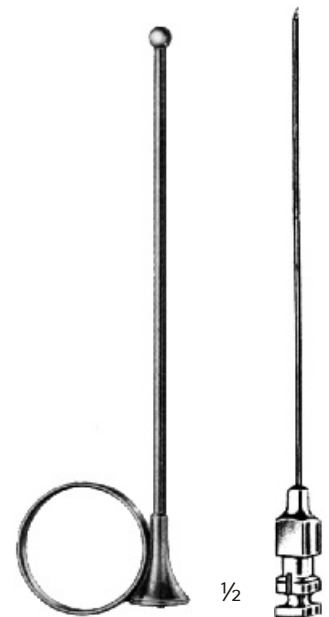

Iowa
 14,0 cm/5½"

24-2679-00

Luer Lock
 0,90 x 150 mm

24-2679-01



24-2680A

Saugkopf allein
Aspiration part only
Part d'aspiration seule
Parte de aspiración suelta

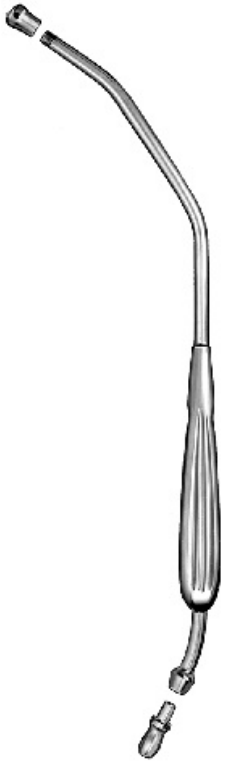

Yankauer

24-2680



10 mmØ
(Charr./Fr. 30)

Poole
22,0 cm/8³/₄"

24-2681



8 mmØ
(Charr./Fr. 24)

Poole
22,0 cm/8³/₄"

24-2682



De Bakey
27,5 cm/10³/₄"

24-2683

24



Magill

Magill-Baby



24-2689

15,0 cm/6"
für Kleinkinder
pediatric size
pour bébés
para párvulos



24-2690

20,0 cm/8"
für Kinder
for children
pour enfants
para niños



24-2691

25,0 cm/10"
für Erwachsene
for adults
pour adultes
para adultos



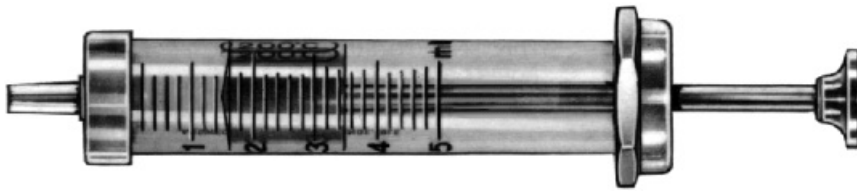

Luer

24-2692-01	1 ml
24-2692-02	2 ml
24-2692-05	5 ml
24-2692-10	10 ml
24-2692-20	20 ml
24-2692-50	50 ml

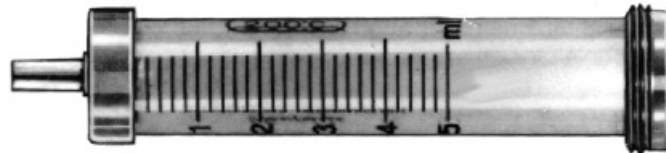

Luer

Zylinder	24-2693-01	1 ml
Barrels	24-2693-02	2 ml
Cylindre	24-2693-05	5 ml
Cilindro	24-2693-10	10 ml
	24-2693-20	20 ml
	24-2693-50	50 ml

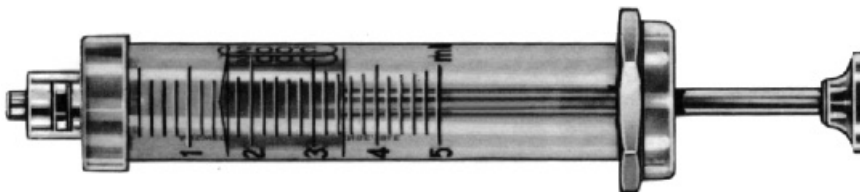

Luer Lock

24-2694-01	1 ml
24-2694-02	2 ml
24-2694-05	5 ml
24-2694-10	10 ml
24-2694-20	20 ml
24-2694-50	50 ml

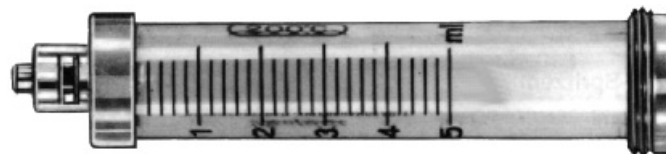

Luer Lock

Zylinder	24-2695-01	1 ml
Barrels	24-2695-02	2 ml
Cylindre	24-2695-05	5 ml
Cilindro	24-2695-10	10 ml
	24-2695-20	20 ml
	24-2695-50	50 ml

24

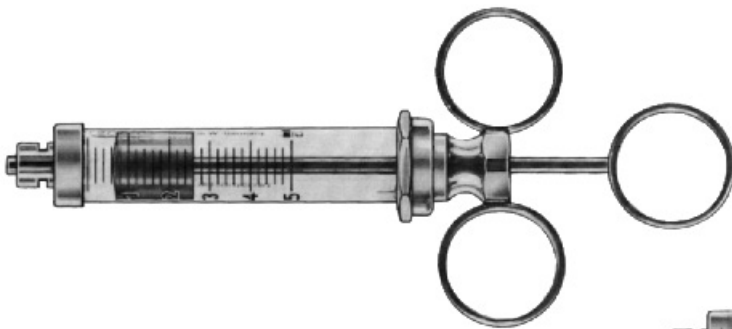

Spritze mit Luer-Lock Ansatz (mit 3 Ringen)
Syringe with Luer-Lock joint (with 3 rings)
Seringue avec arrêt Luer-Lock (avec 3 anneaux)
Jeringa con cierre Luer-Lock (con 3 anillos)

24-2696-02	2 ml
24-2696-05	5 ml
24-2696-10	10 ml



Zylinder	24-2697-02	2 ml
Barrels	24-2697-05	5 ml
Cylindre	24-2697-10	10 ml
Cilindro		

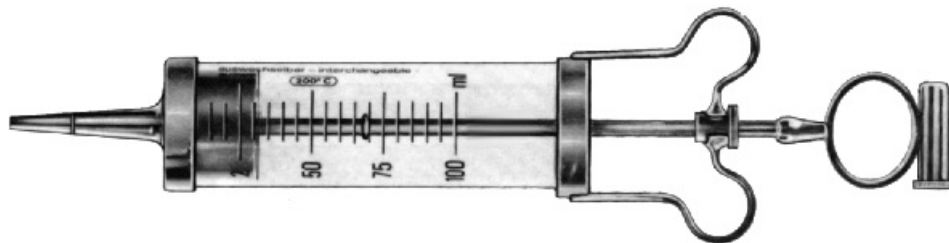

Janet

24-2698-05	50 ml
24-2698-07	75 ml
24-2698-10	100 ml
24-2698-15	150 ml
24-2698-20	200 ml
24-2698-25	250 ml

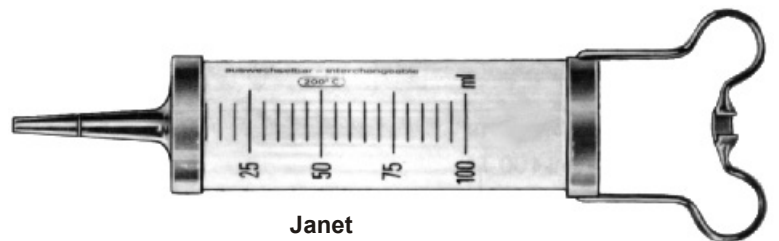

Janet

Zylinder	24-2699-05	50 ml
Barrels	24-2699-07	75 ml
Cylindre	24-2699-10	100 ml
Cilindro	24-2699-15	150 ml
	24-2699-20	200 ml
	24-2699-25	250 ml

Sonden, Watteträger, Spatel, Veneninstrumente
Probes, Applicators, Spatulas, Vein Instruments
Sondes, Porte-cotons, Spatules, Instruments à varices
Sondas, Porta-algodones, Espátulas, Instrumentos para várices



5
2

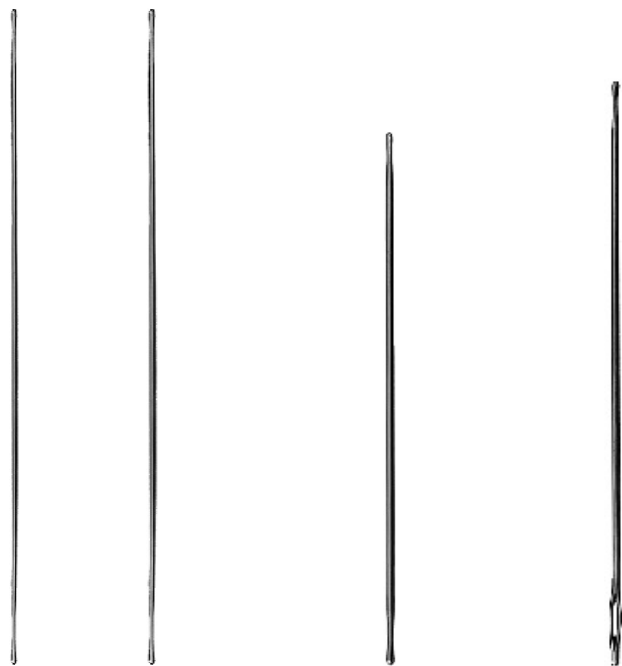

cm	in.	1,0 mmØ	1,5 mmØ	2,0 mmØ	2,0 mmØ
11,5	4½	25-2701		25-2711	25-2731
13,0	5	25-2703		25-2713	25-2733
14,5	5½	25-2704	25-2715-14	25-2714	25-2734
16,0	6¼	25-2706	25-2715-16	25-2716	25-2736
18,0	7	25-2708	25-2715-18	25-2718	25-2738
20,0	8	25-2710	25-2715-20	25-2720	25-2740
25,0	10			25-2725	25-2745

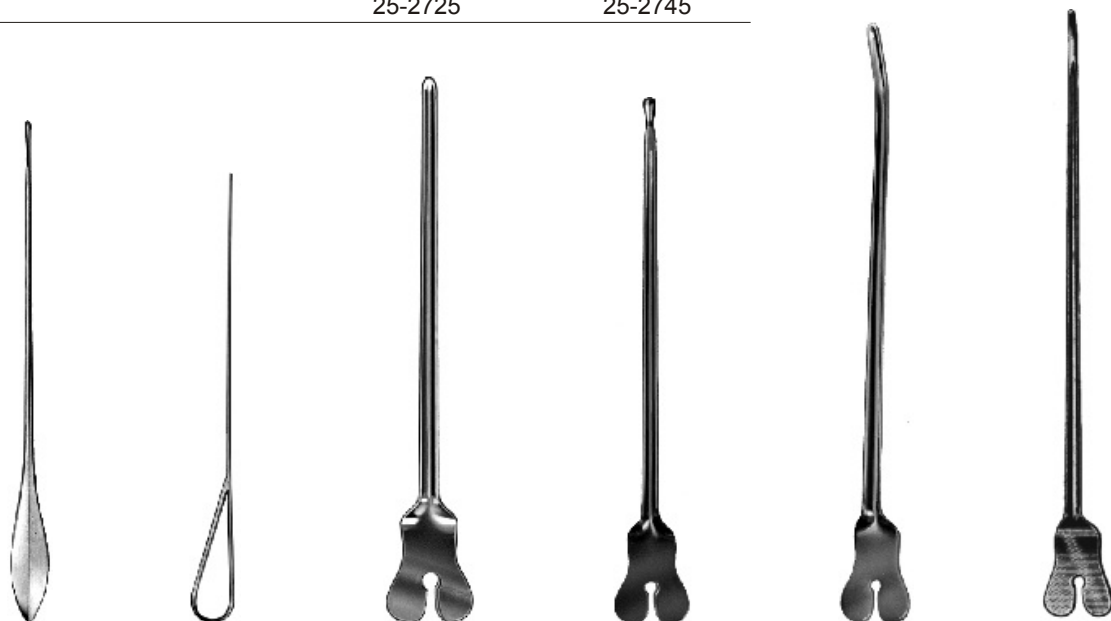

cm	in.		Stacke		Doyen	Nélaton
10,5	4¼		25-2760			
11,5	4½	25-2751		25-2761		
13,0	5	25-2753		25-2763	25-2773	
14,0	5½	25-2754		25-2764	25.2774	25-2780
16,0	6¼	25-2756		25-2766	25.2776	25-2781
18,0	7			25-2768		
20,0	8			25-2770		





Watson-Cheyne

25-2782-13 13,0 cm/5"
25-2782-18 18,0 cm/7¼"



Roser

25-2785 12,5 cm/5"

25



Lockhart-Mummery
16,5 cm/6½"



Fig. 1
25-2786-01

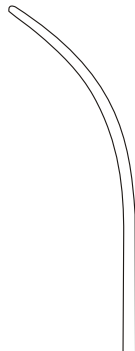

Fig. 2
25-2786-02

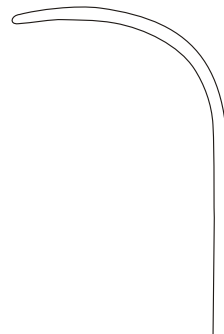

Fig. 3
25-2786-03

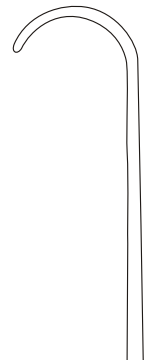

Fig. 4
25-2786-04

Fistelsonden
Fistula probes
Sondes pour fistules
Sondas para fístulas



Pflasterspatel
Plaster Spatula
Spatules
Espátulas

25-2800-13 13,0 cm/5"
25-2800-14 14,5 cm/5½"



Farrell
(Lathbury)

	cm	in.	mmØ
25-2812-09	12,0	4¾	0,9
25-2814-01	14,0	5½	1,0
25-2814-09	14,0	5½	0,9
25-2814-12	14,0	5½	1,2
25-2816-11	16,5	6½	1,1
25-2818-12	18,0	7	1,2
25-2818-15	18,0	7	1,5
25-2818-18	18,0	7	1,8



Jobson-Horne

25-2820-18
18,0 cm/7"

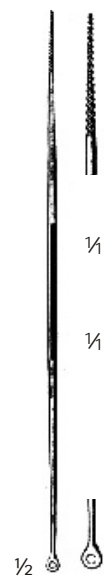

Uckermann

25-2822
16,0 cm/6¼"



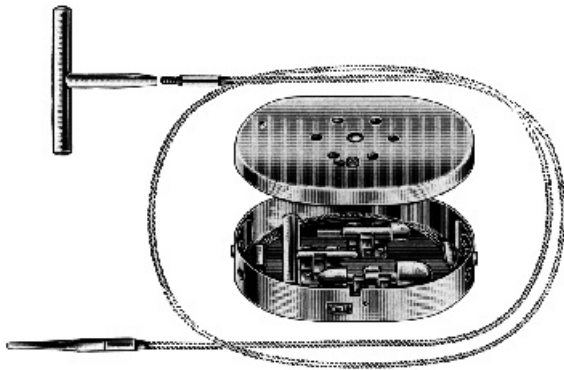

Nabatoff

25-2850-00
135 x 100 x 25 mm
Satz komplett
Set complete
Jeu complet
Juego completo

25-2850-70
Metalletui allein
Metal case only
Boîte métal seule
Estuche de metal suelto

25-2850-02

25-2850-50

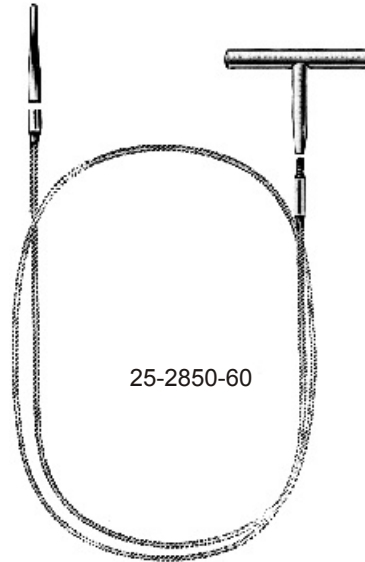

25-2850-60

1/4



25-2850-03
Ø 3,0 mm



25-2850-06
Ø 6,0 mm



25-2850-09
Ø 9,0 mm



25-2850-12
Ø 12,0 mm

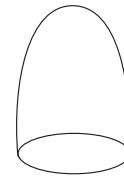

25-2850-15
Ø 15,0 mm



Endarterektomiestripper, Endarterectomy strippers, Sondes pour endartérectomie, Sondas para endarterectomía

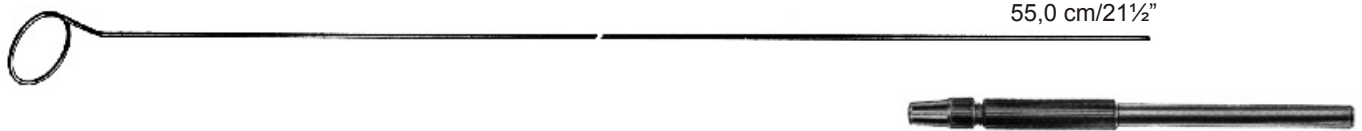

55,0 cm/21½"



25-2852-50
12,0 cm/4¼"
Griff allein
Handle only
Manche seule
Mango suelto

25-2852-02
2,0 mmØ

25-2852-03
3,0 mmØ

25-2852-04
4,0 mmØ

25-2852-06
6,0 mmØ

25-2852-07
7,0 mmØ

25-2852-08
8,0 mmØ

25-2852-10
10,0 mmØ

25-2852-12
12,0 mmØ

25-2852-14
14,0 mmØ

Wundhaken, Wundsperrer
Retractors
Ecarteurs
Separadores





16,0 cm/6½"

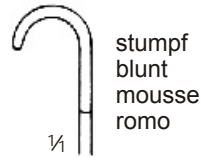
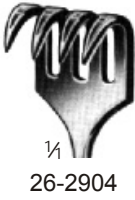
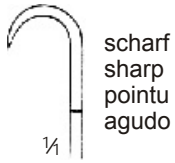

6
2



16,0 cm/6½"
flexibel
flexible
flexible
flexible

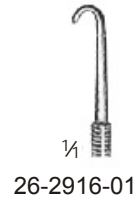
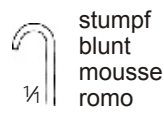
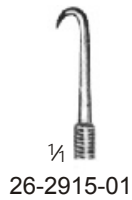
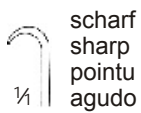



16,0 cm/6½"

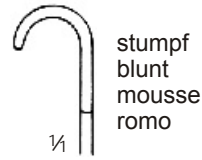

Meyerding
18,0 cm/7"

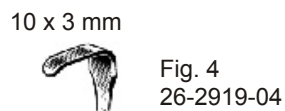



Cushing
 20,0 cm/8"

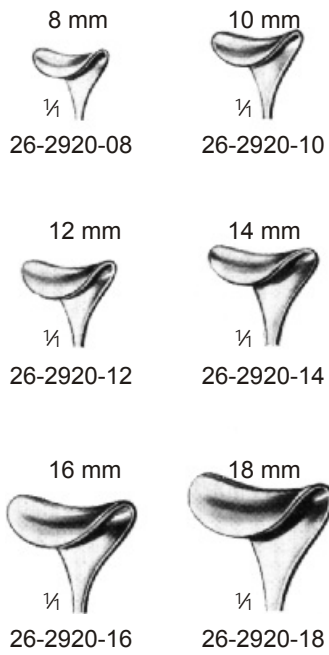

Cushing
 24,0 cm/9 1/2"

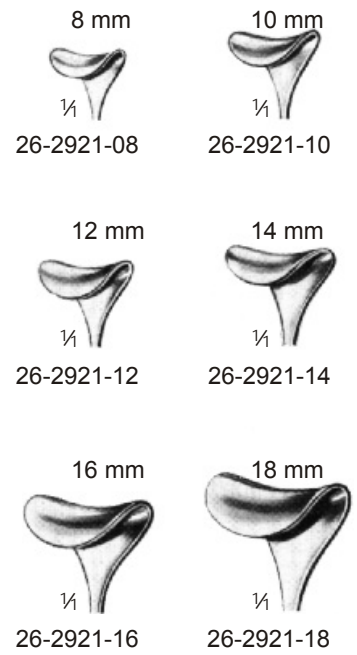

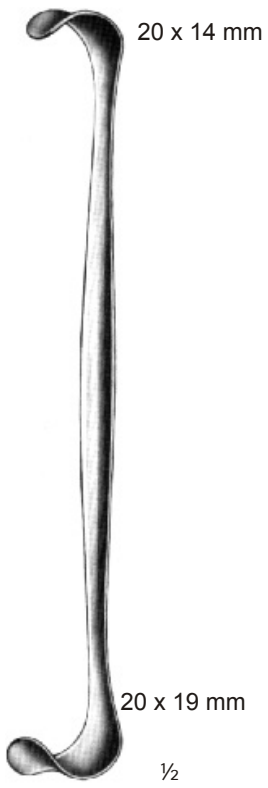

26-2922
 20,0 cm/8"



Crile
 26-2923
 11,0 cm/4 1/4"



Klapp
 17,5 cm/7"

Sehnscheidenhaken
 Tendon Sheath Retractors
 Ecarteurs pour la gaine
 Separadores para tendones

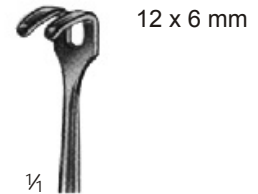

26-2924-01

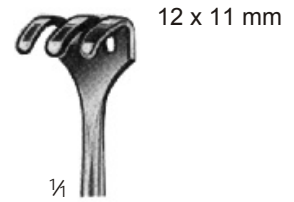

26-2924-02



Mini-Langenbeck
 16,0 cm/6 1/2"



26-2925-10

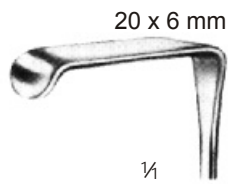

26-2925-20

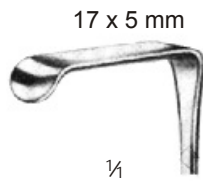

26-2925-17

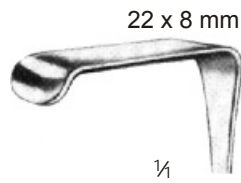

26-2925-22



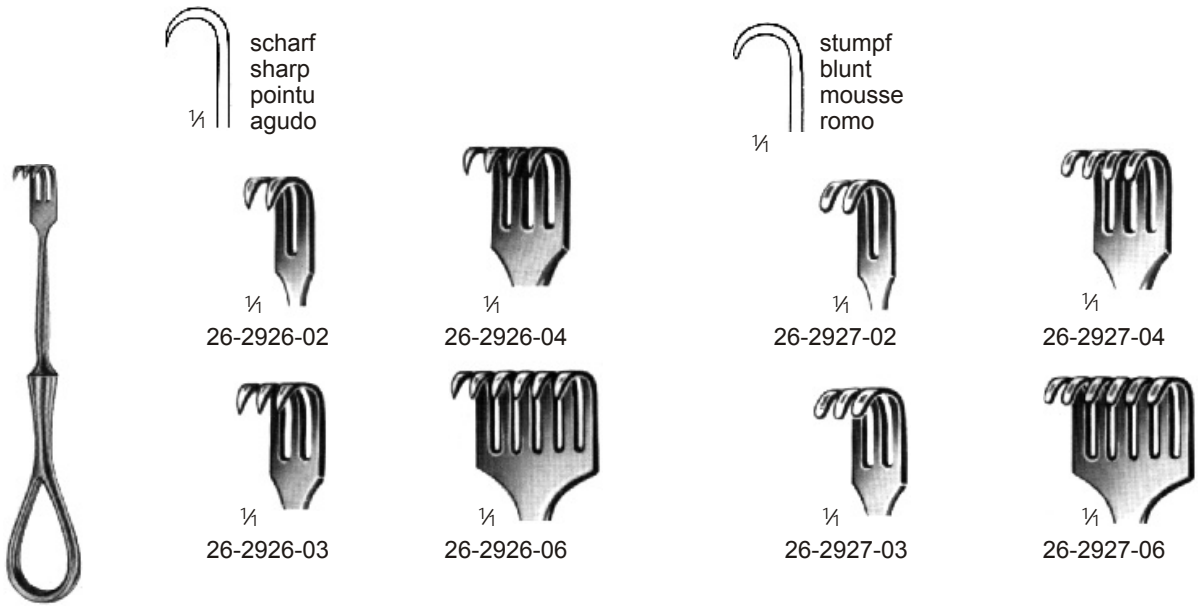

Volkman
11,5 cm/4½"

26

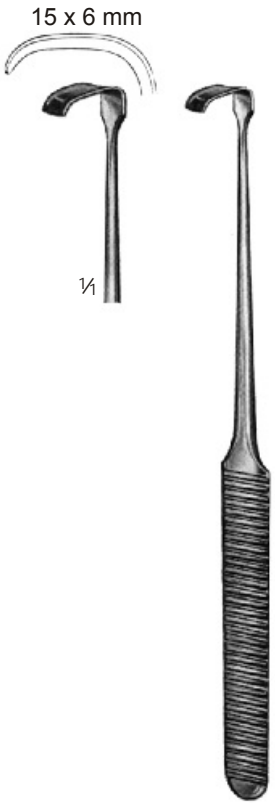

Strandell-Stille

26-2930-01
19,0 cm/7½"

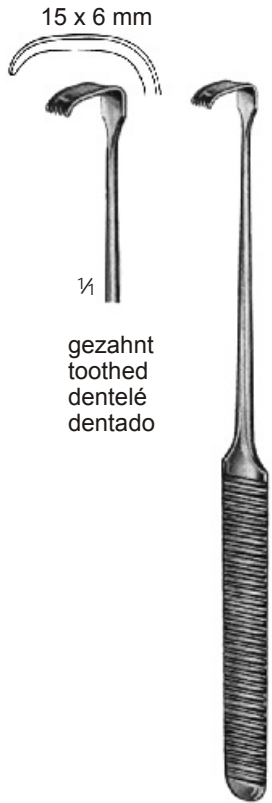

Strandell-Stille

26-2930-02
19,0 cm/7½"



Cushing

26-2931
20,0 cm/8"

Dekompressionshaken
Decompression hook
Ecarteur de décompression
Separador para descompresión



Volkmann
 23,0 cm/9"



26-3001

scharf
 sharp
 pointu
 agudo



26-3011

stumpf
 blunt
 mousse
 romo



26-3002



26-3004



26-3012



26-3014



26-3003



26-3006



26-3013



26-3016



Volkmann

26-3021
 21,5 cm/8½"

scharf
 sharp
 pointu
 agudo



26-3022



26-3024

stumpf
 blunt
 mousse
 romo



26-3032



26-3034



26-3023



26-3026



26-3033



26-3036

Volkmann

26-3031
 21,5 cm/8½"



scharf
sharp
pointu
agudo



Volkman

26-3040
21,5 cm/8½"

stumpf
blunt
mousse
romo



Volkman

26-3041
21,5 cm/8½"

scharf
sharp
pointu
agudo

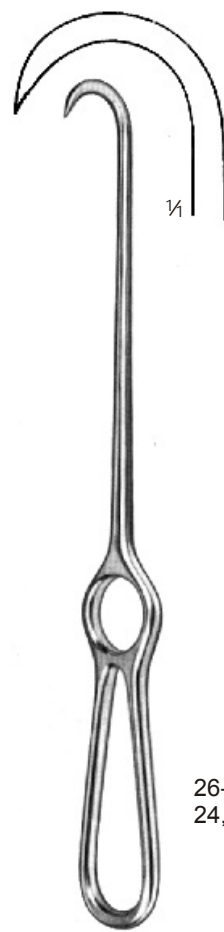

26-3043
24,5 cm/10"



Kocher
22,0 cm/8½"

scharf
sharp
pointu
agudo



26-3051



26-3052



26-3053



26-3054



26-3056

stumpf
blunt
mousse
romo



26-3061



26-3062



26-3063



26-3064

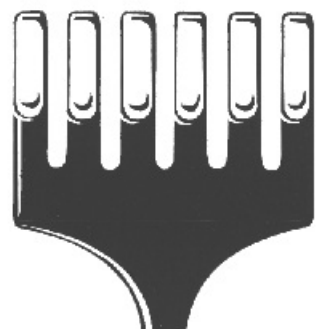

26-3066

206



Koerte
 23,5 cm/9¼"

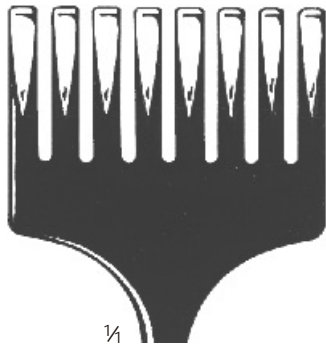

¼
 26-3067

scharf
 sharp
 pointu
 agudo

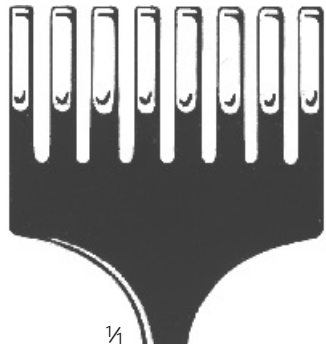

¼
 26-3068

stumpf
 blunt
 mousse
 romo



36 x 30 mm

36 x 60 mm

½

26-3069-03

26-3069-04

33 x 20 mm



Wassmund

26-3070-20
 20,5 cm/8"

Ollier
 22,5 cm/9"

½





1/2

Israel
25,0 cm/10"

40 x 40 mm

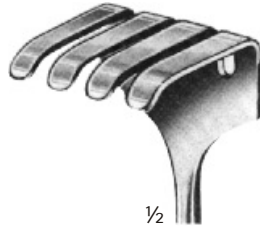

1/2

26-3074-04

45 x 50 mm



1/2

26-3074-05

50 x 60 mm

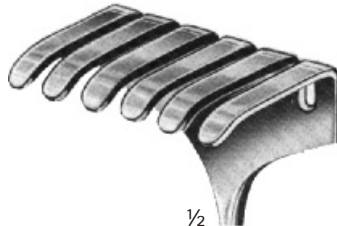

1/2

26-3074-06

70 x 70 mm

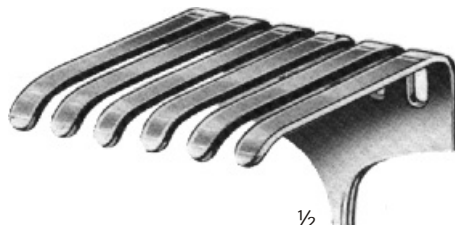

1/2

26-3074-07





Hüftgelenkhaken
Retractors
Ecarteurs
Separadores

½

Langenbeck
21,0 cm/8¼"

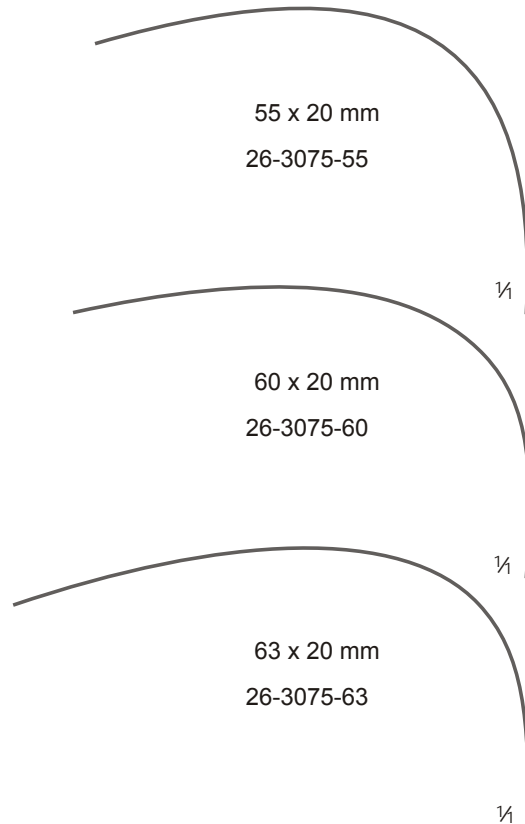

½

Langenbeck
21,0 cm/8¼"

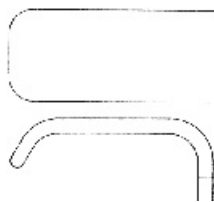

Kocher
21,5 cm/8½"

26-3076	40 x 18 mm
26-3077	60 x 20 mm
26-3078	60 x 25 mm
26-3079	75 x 30 mm
26-3080	75 x 40 mm



Langenbeck
21,0 cm/8¼"

26-3085	30 x 11 mm
26-3086	30 x 14 mm
26-3087	30 x 16 mm
26-3088	40 x 11 mm
26-3089	50 x 11 mm



Kocher-Langenbeck
21,5 cm/8½"

26-3090	25 x 6 mm
26-3091	35 x 8 mm
26-3092	35 x 11 mm
26-3093	35 x 15 mm
26-3094	40 x 11 mm
26-3095	55 x 11 mm
26-3096	70 x 14 mm
26-3097	80 x 12 mm
26-3098	80 x 16 mm





1/2

Langenbeck
22,0 cm/8 3/4"



26-3081 30 x 11 mm
26-3082 30 x 14 mm
26-3083 30 x 16 mm



26-3084 40 x 11 mm



1/2

Sauerbruch
22,5 cm/9"

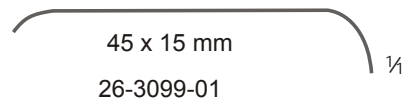

45 x 15 mm

26-3099-01

1/4

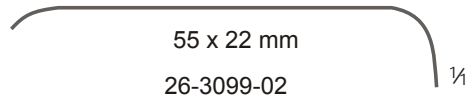

55 x 22 mm

26-3099-02

1/4

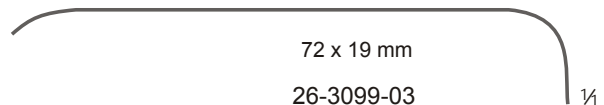

72 x 19 mm

26-3099-03

1/4





Lahey

26-3100
 19,0 cm/7½"

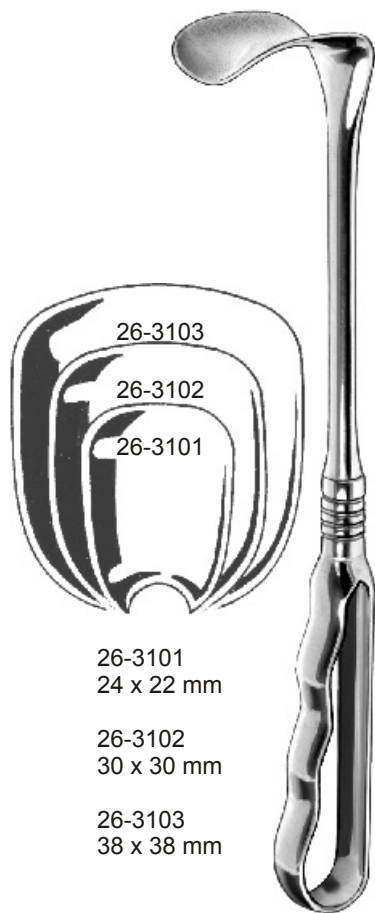

Richardson
 24,0 cm/9½"



Richardson

26-3104
 24,0 cm/9½"



Kelly

26-3105
 26,0 cm/10¼"

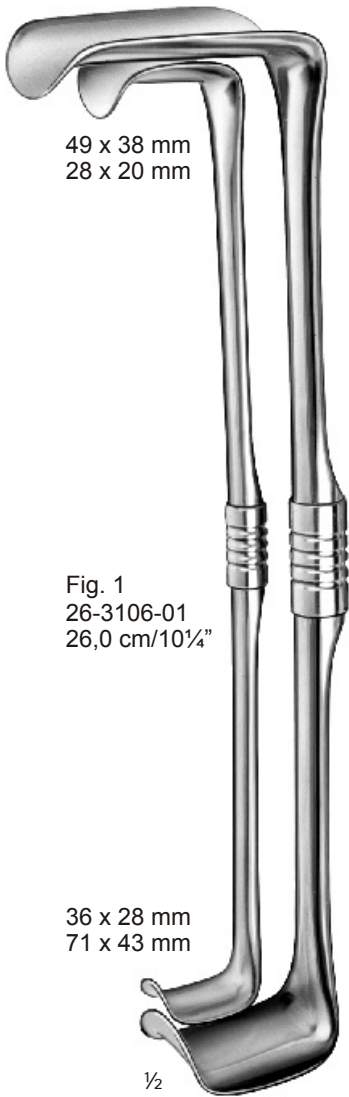

Richardson-Eastman

26-3106
 Satz 2-teilig
 Set of 2 pieces
 Jeu de 2 pièces
 Juego de 2 piezas

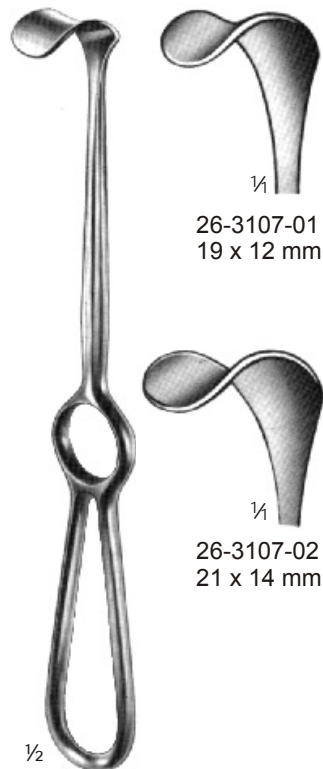

Kocher
20,5 cm/8"



Kocher
22,0 cm/8³/₄"

26-3108-01
40 x 10 mm

26-3108-02
40 x 15 mm

26-3108-03
40 x 20 mm

26

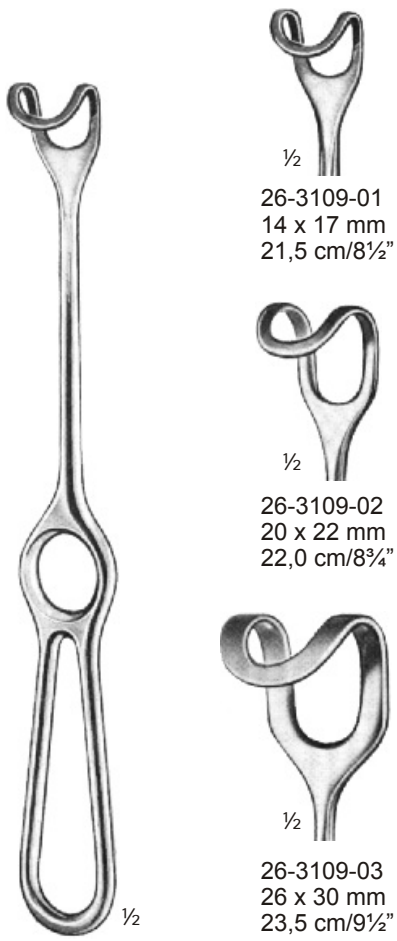

Middeldorpf

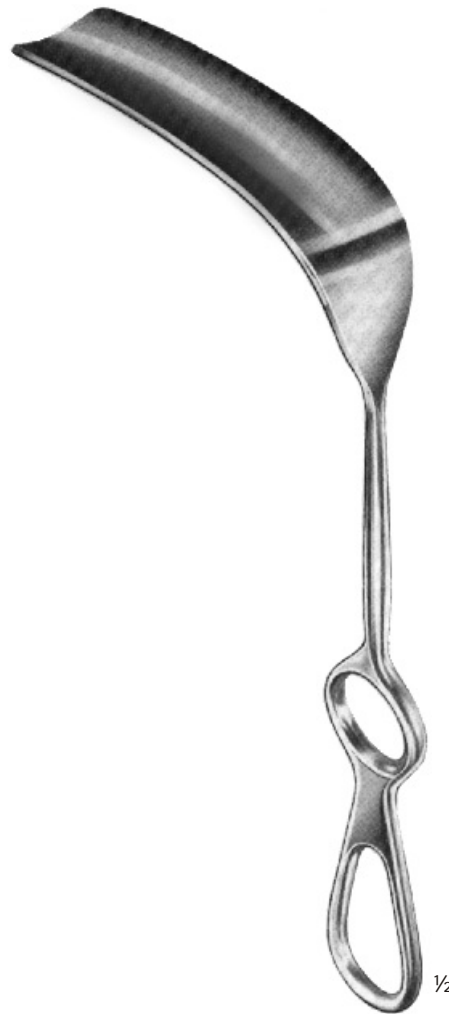
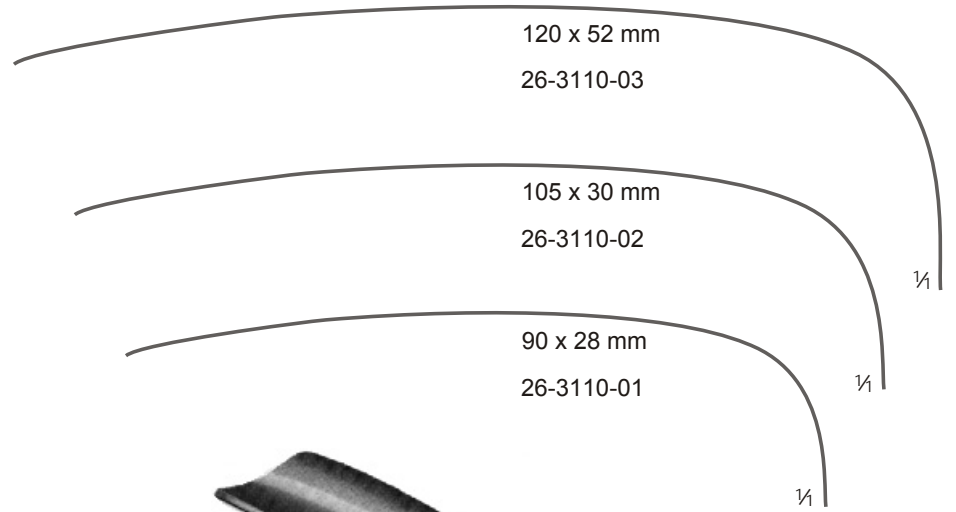

Doyen-Stillé
22,0 cm/8¼"

206

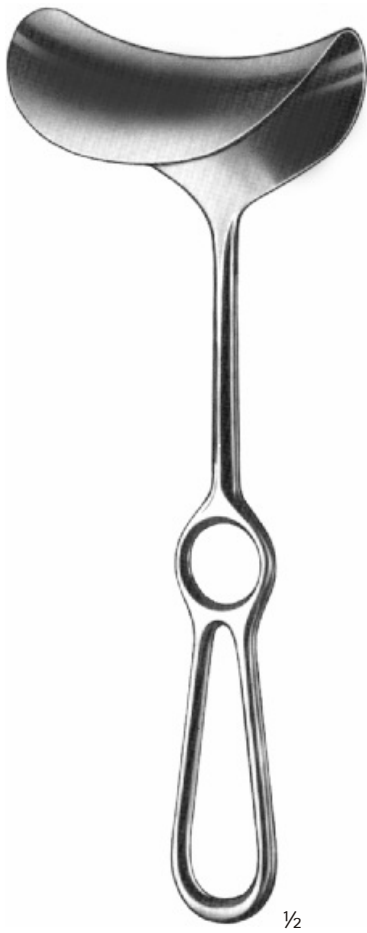

Fritsch
24,0 cm/9½"

- 26-3111 Fig. 1 40 x 40 mm
- 26-3112 Fig. 2 45 x 50 mm
- 26-3113 Fig. 3 45 x 60 mm
- 26-3114 Fig. 4 45 x 75 mm



Middeldorpf
27,5 cm/11"

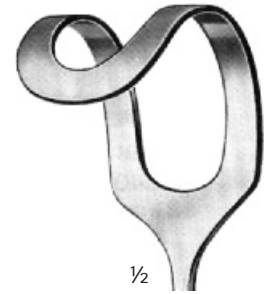

½
26-3115-01
45 x 45 mm

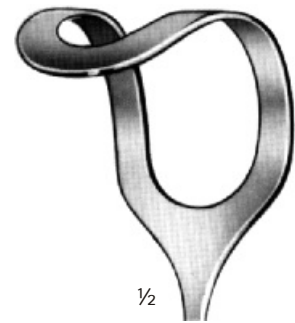

½
26-3115-02
45 x 50 mm

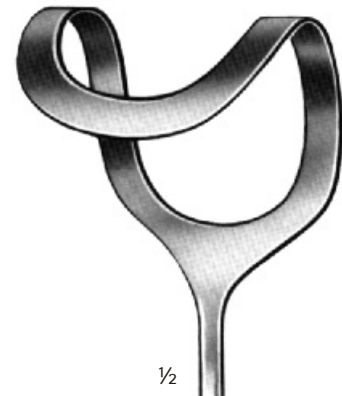

½
26-3115-03
55 x 70 mm

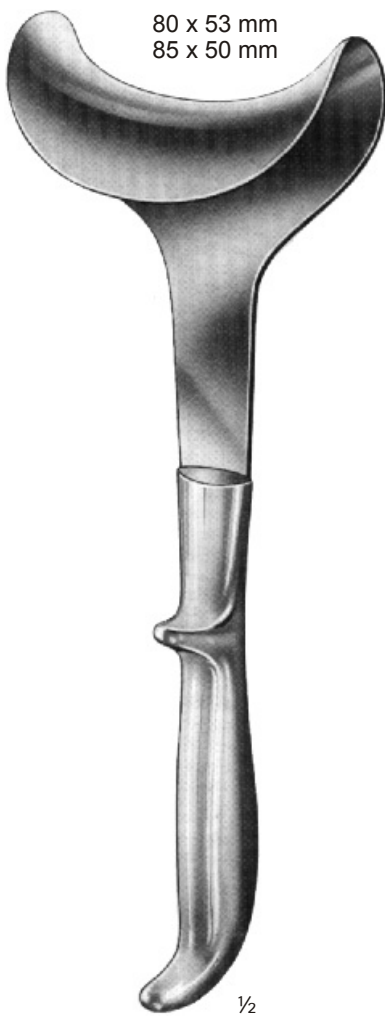

Doyen
25,0 cm/10"

26-3116-80 53 x 80 mm
26-3116-85 50 x 85 mm

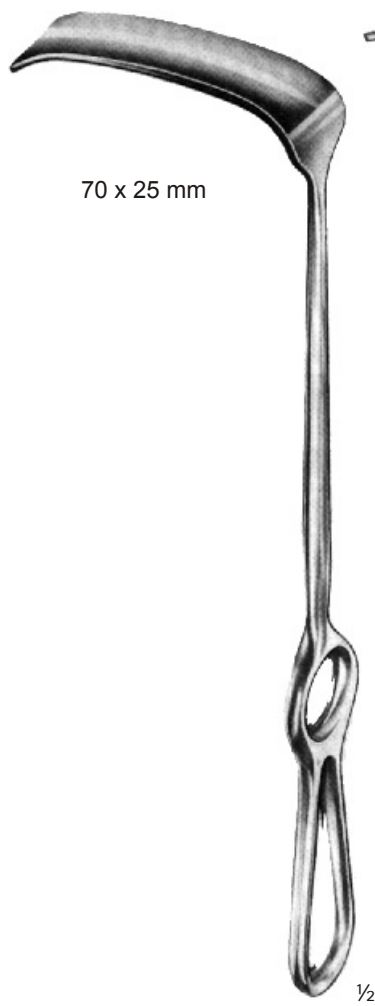

Kocher
23,5 cm/9 1/4"

26-3117-23

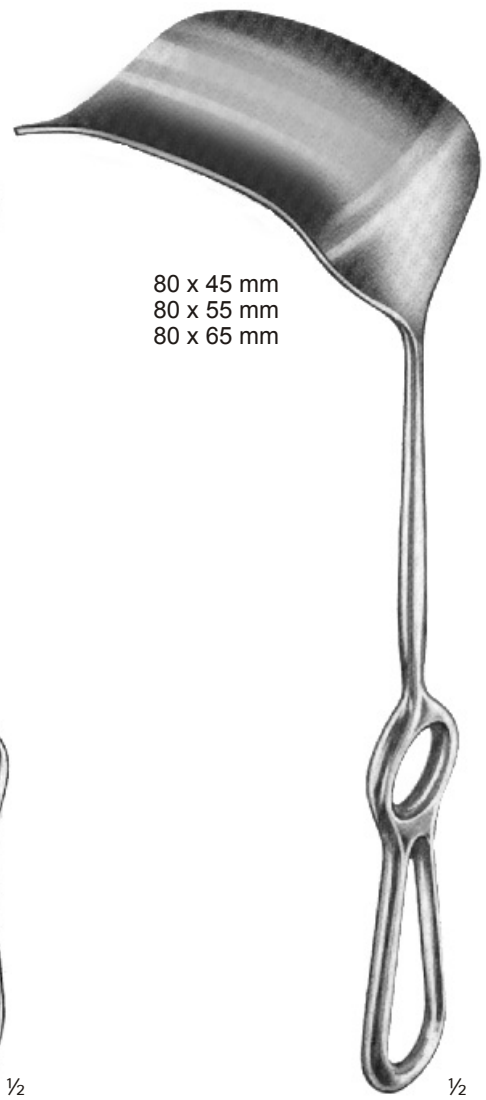

Kocher
25,0 cm/10"

26-3118-01 80 x 45 mm
26-3118-02 80 x 55 mm
26-3118-03 80 x 65 mm

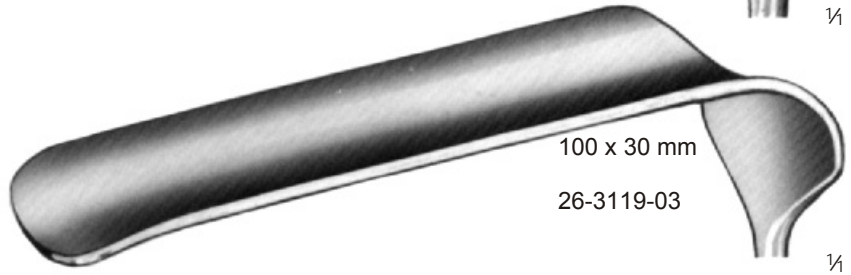
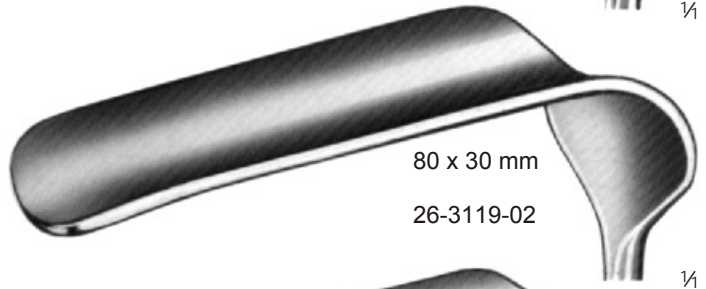
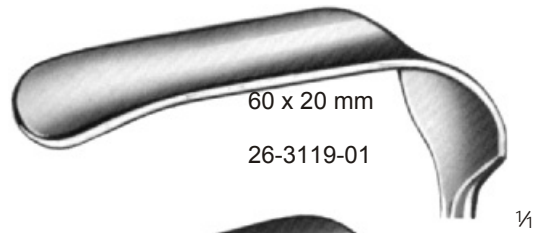

26



Zenker

35 x 8 mm
26-3120-01
23,5 cm/9¹/₄" $\frac{1}{4}$

60 x 12 mm
26-3120-02
26,0 cm/10¹/₄" $\frac{1}{4}$

75 x 12 mm
26-3120-03
27,5 cm/10³/₄" $\frac{1}{4}$

120 x 12 mm
26-3120-04
29,0 cm/11¹/₂" $\frac{1}{4}$



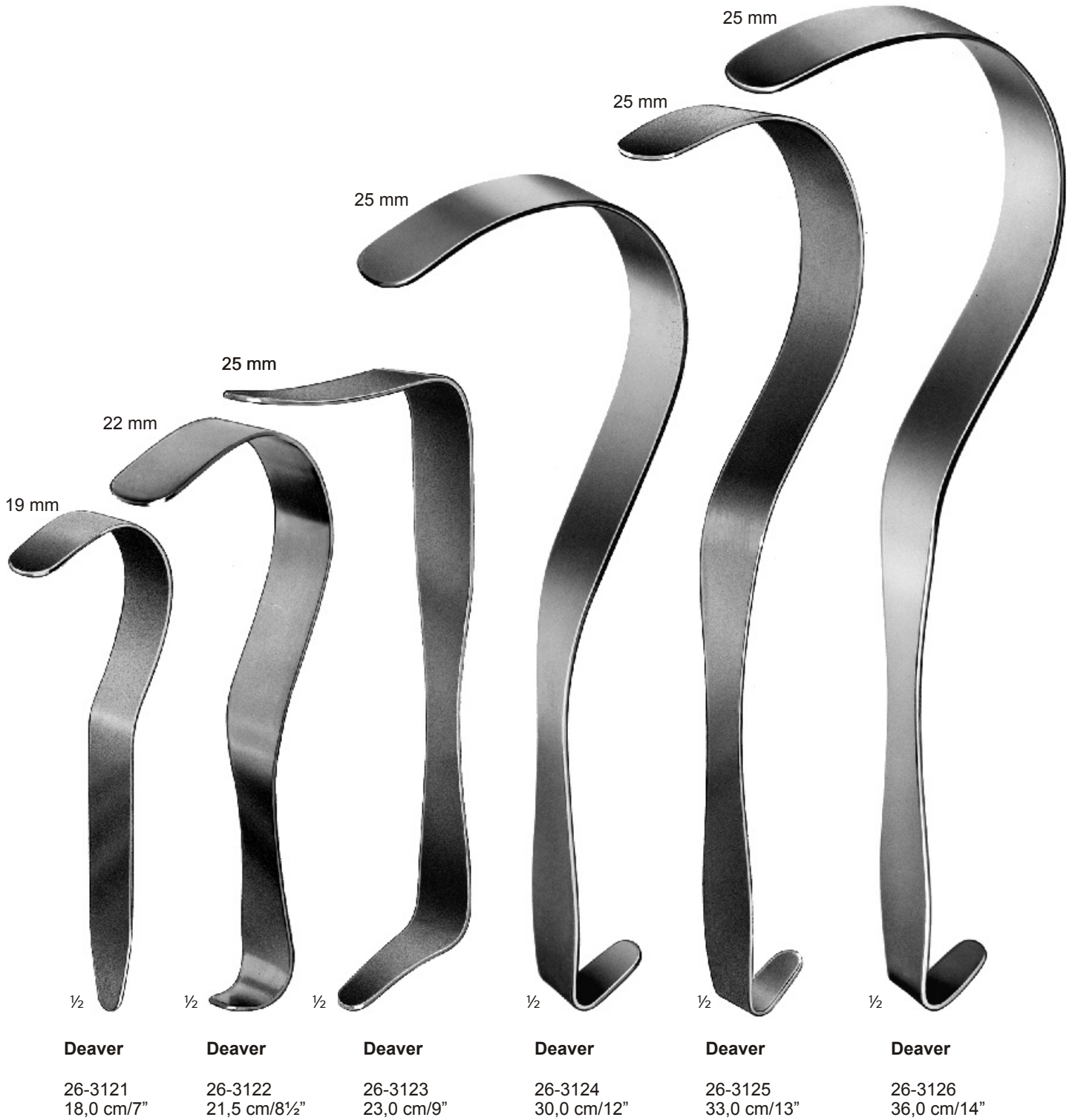



38 mm

Deaver

26-3127
 30,0 cm/12"



50 mm

Deaver

26-3128
 30,0 cm/12"



75 mm

Deaver

26-3129
 30,0 cm/12"



Harrington

32,0 cm/12½"

26-3132 127 x 40 mm
 26-3133 127 x 62 mm



115 x 22 mm
115 x 26 mm



Simon
27,5 cm/10³/₄"

26-3135-01 115 x 22 mm
26-3135-02 115 x 26 mm

95 x 20 mm



Modell Tübingen

26-3136-26
26,5 cm/10¹/₂"

105 x 27 mm



Martin

26-3137-25
25,0 cm/10"

206

115 x 65 mm
26-3138-03

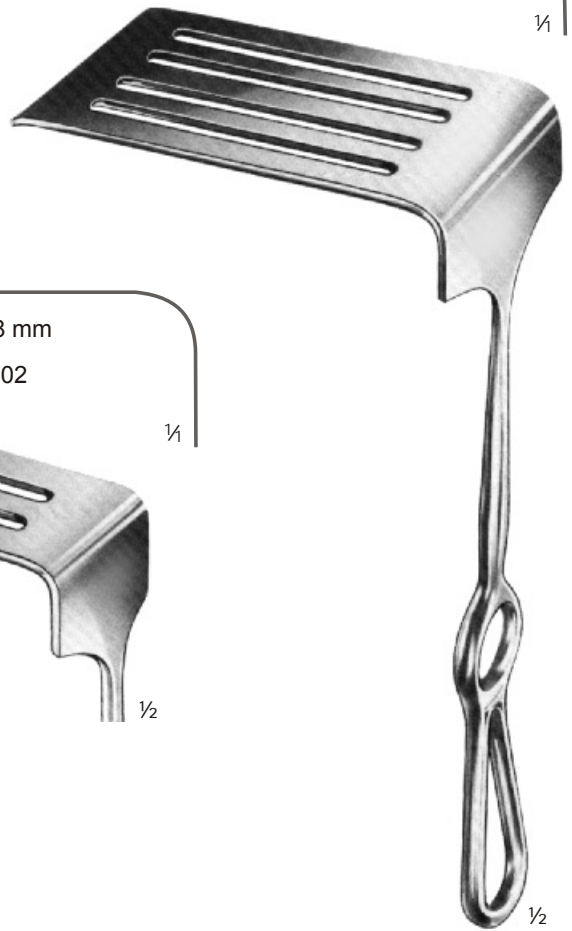

115 x 38 mm
26-3138-02

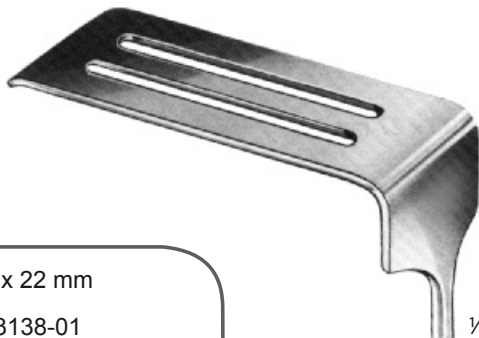

82 x 22 mm
26-3138-01



Coryllos
24,0 cm/9½"



26-3139-01
75 x 50 mm

26-3139-02
75 x 90 mm

Davidson
16,0 cm/6¼"



125 x 37 mm

¼

Sauerbruch

26-3140-25
25,0 cm/10"

½

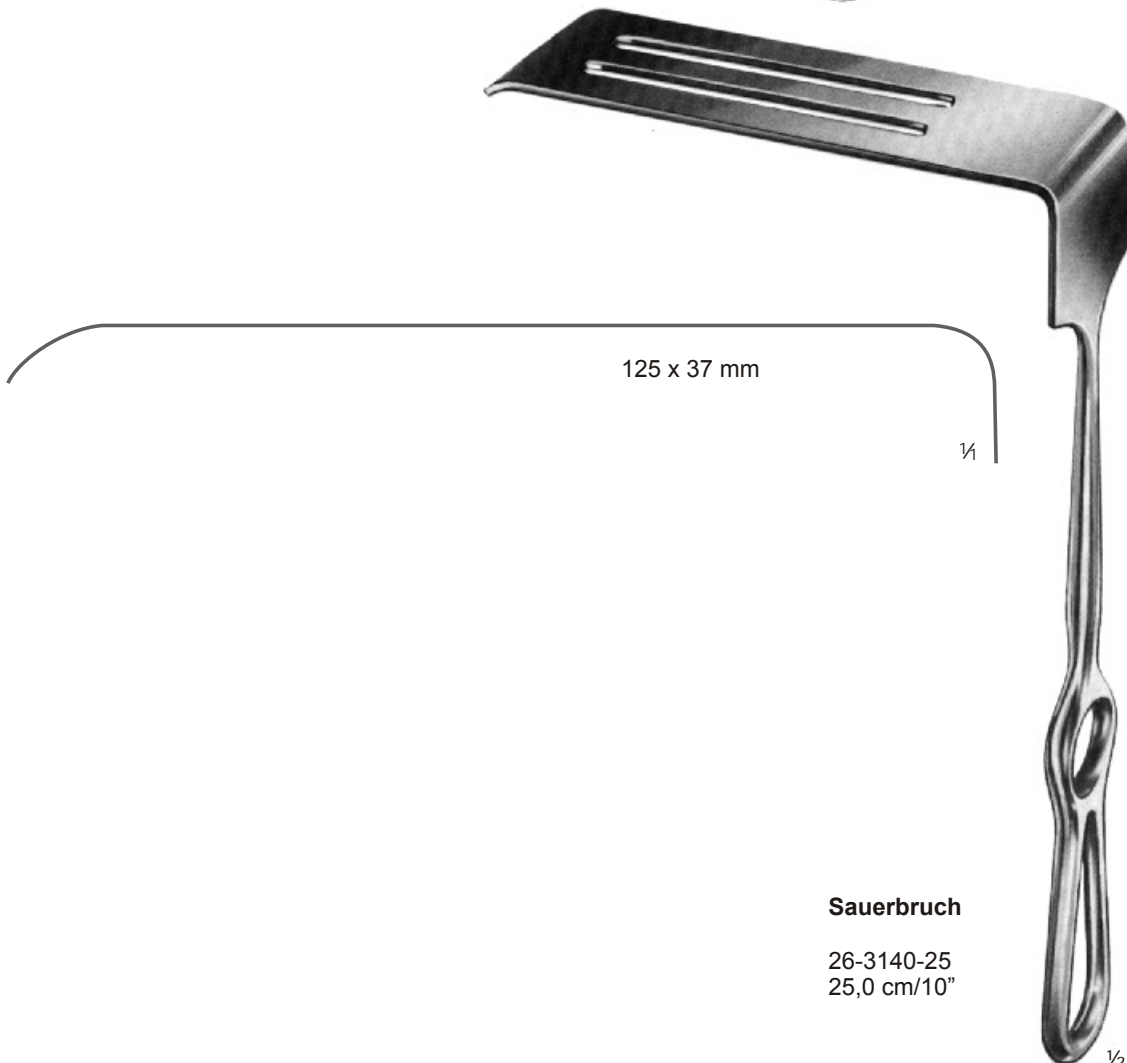

- 26-3144-18 180 x 30 mm
- 26-3144-16 160 x 30 mm
- 26-3144-14 140 x 30 mm
- 26-3144-13 130 x 30 mm
- 26-3144-12 120 x 25 mm
- 26-3144-10 100 x 25 mm
- 26-3144-08 80 x 20 mm



Mikulicz
26,0 cm/10¼"

- 26-3141 85 x 35 mm
- 26-3142 120 x 50 mm
- 26-3143 155 x 50 mm

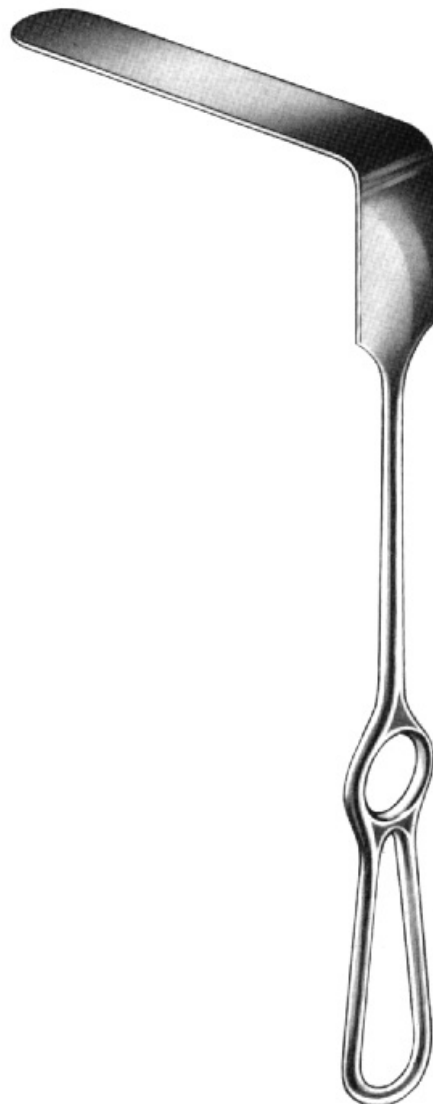

Brunner
25,0 cm/10"



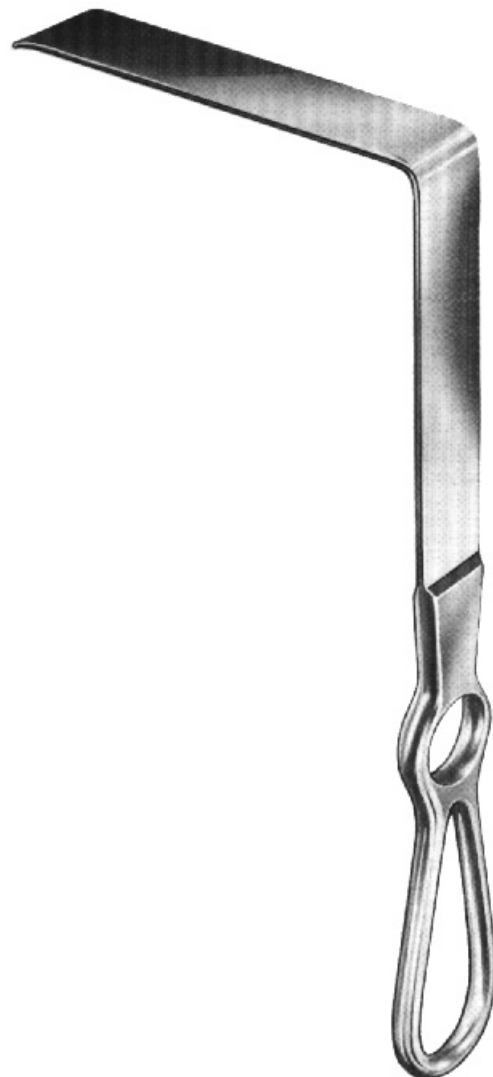
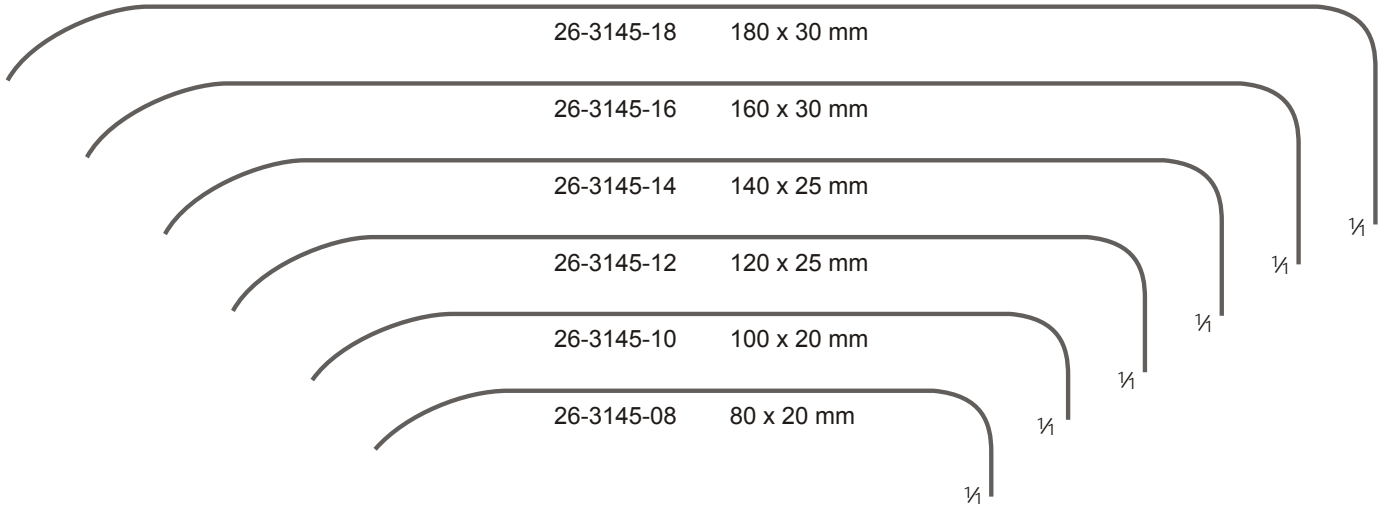

Brunner
25,0 cm/10"

26-3146-16 50 x 16 mm



26-3146-25 75 x 25 mm



26-3146-50 90 x 50 mm



Meyerding
22,5 cm/9"

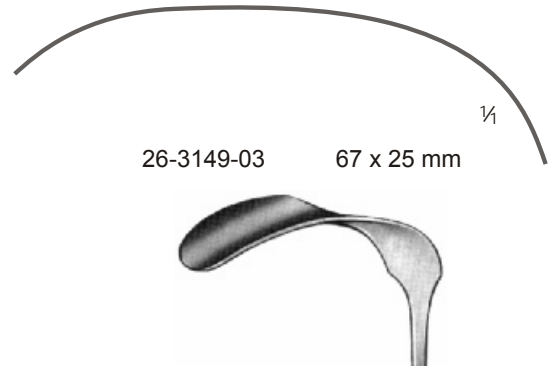
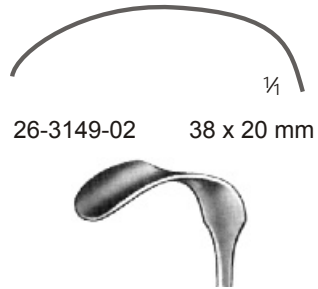
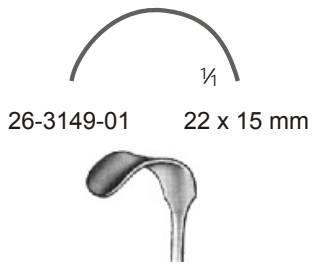

26

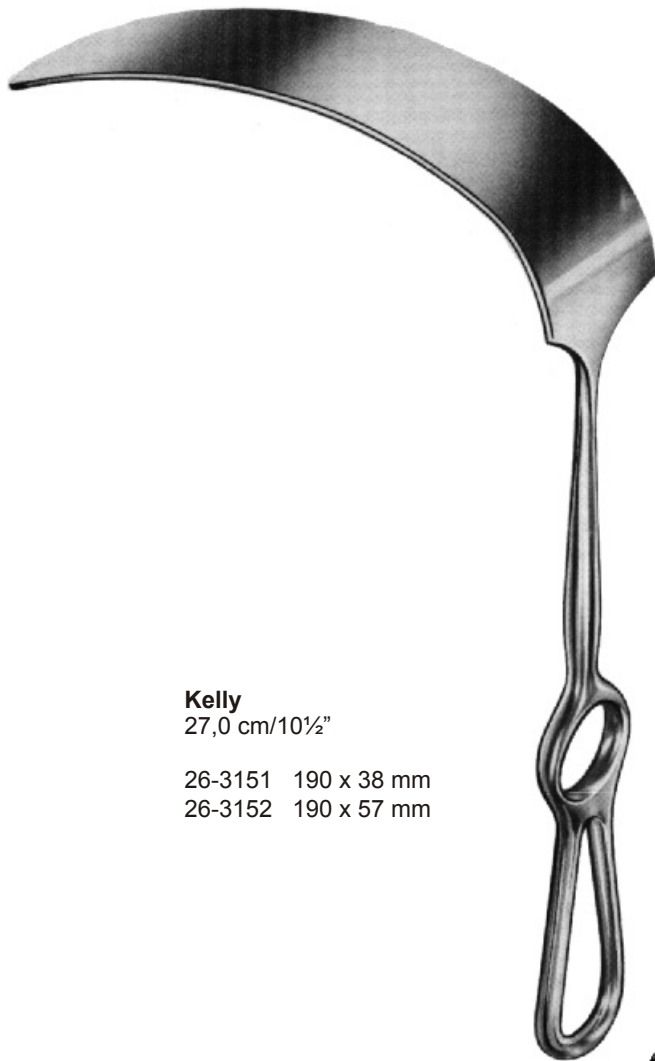

Kelly
 27,0 cm/10½"

26-3151 190 x 38 mm
 26-3152 190 x 57 mm



Baby-Senn-Miller
 15,5 cm/6"



26-3153-01

scharf
 sharp
 pointu
 agudo



26-3153-02

stumpf
 blunt
 mousse
 romo



Ragnell-Davis

26-3154
 14,0 cm/5½"



Senn-Miller
 16,0 cm/6¼"



26-3155
 scharf
 sharp
 pointu
 agudo



26-3156
 stumpf
 blunt
 mousse
 romo



Senn-Green
 15,0 cm/6"



26-3157
 20 x 6 mm



26-3158
 10 x 6 mm



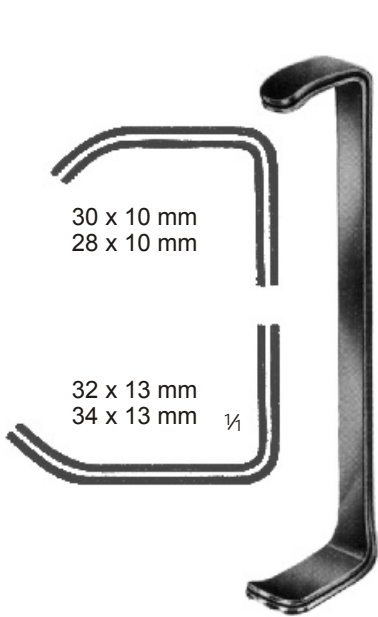

30 x 10 mm
28 x 10 mm

32 x 13 mm
34 x 13 mm ¼

Farabeuf
12,0 cm/4¾"

26-3160
Satz, set
jeu, juego

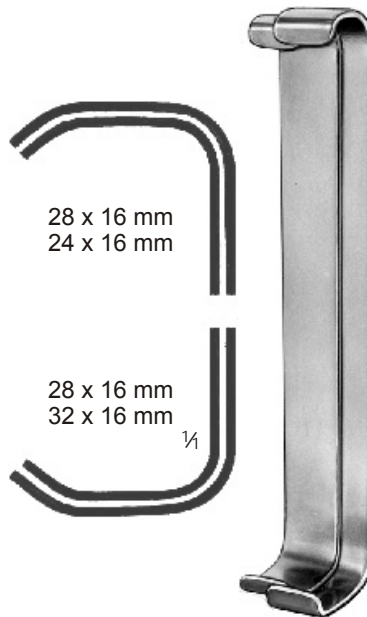

28 x 16 mm
24 x 16 mm

28 x 16 mm
32 x 16 mm ¼

Farabeuf
15,0 cm/6"

26-3161
Satz, set
jeu, juego

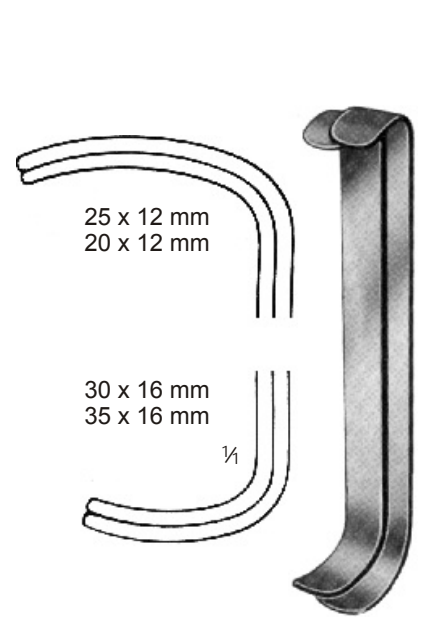

25 x 12 mm
20 x 12 mm

30 x 16 mm
35 x 16 mm ¼

Collin
15,0 cm/6"

26-3162
Satz, set
jeu, juego

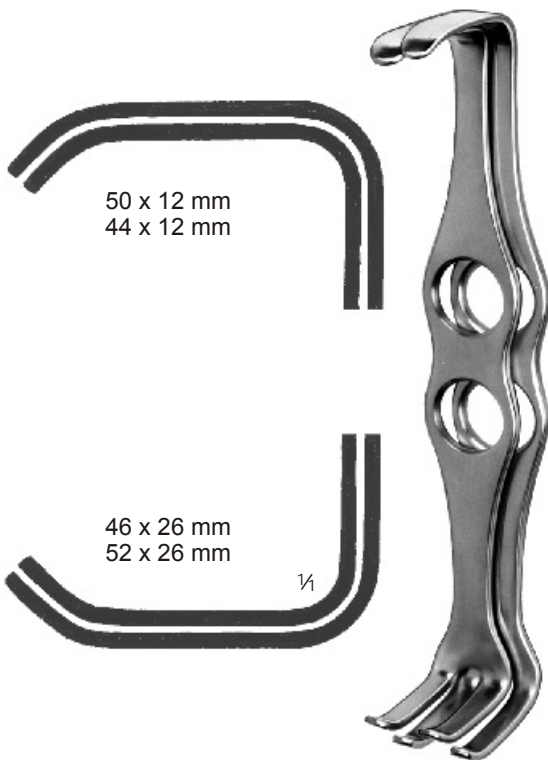

50 x 12 mm
44 x 12 mm

46 x 26 mm
52 x 26 mm ¼

Mathieu
20,0 cm/8"

26-3164
Satz, set
jeu, juego

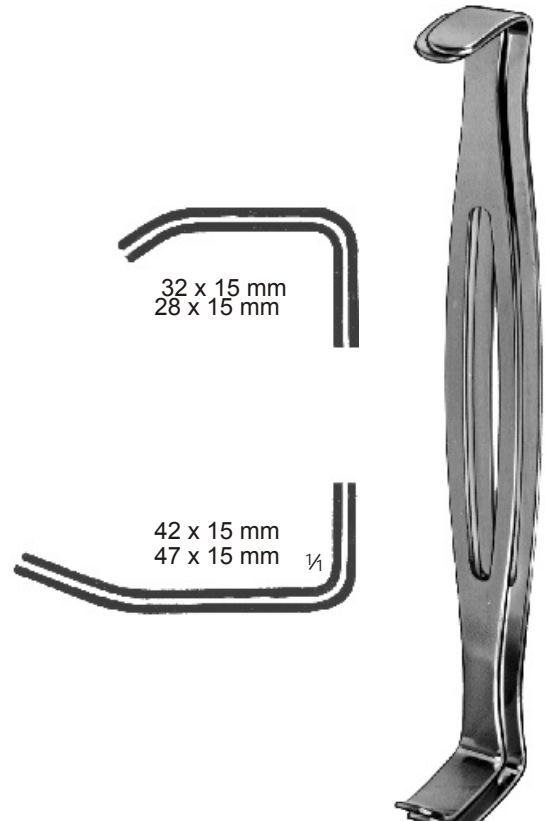

32 x 15 mm
28 x 15 mm

42 x 15 mm
47 x 15 mm ¼

Parker-Langenbeck
(US-Army)
21,0 cm/8¼"

26-3165
Satz, set
jeu, juego

26

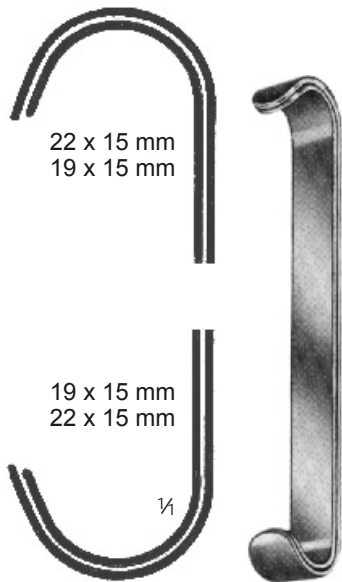

Parker
13,5 cm/5¼"

26-3166
Satz, set
jeu, juego

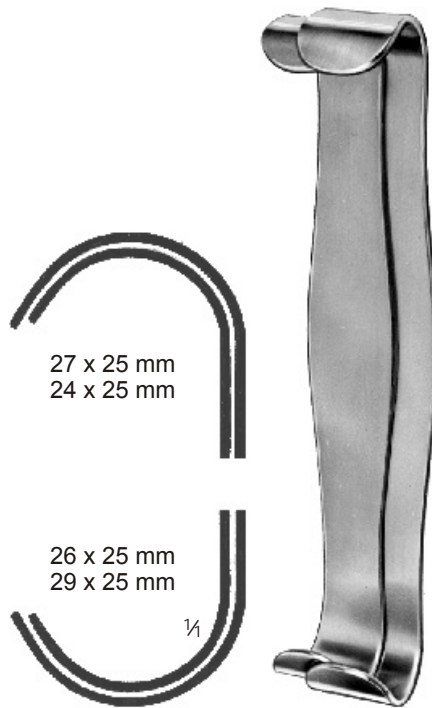

Parker
18,0 cm/7"

26-3167
Satz, set
jeu, juego

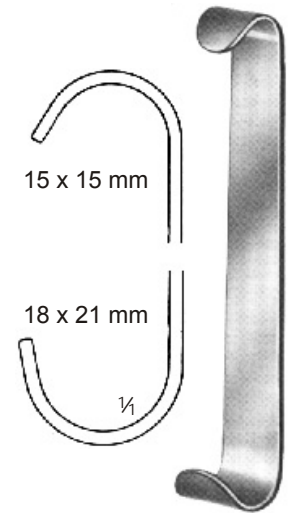

Baby-Roux
13,0 cm/5¼"

26-3168



Mini-Roux
15,0 cm/6"

26-3169

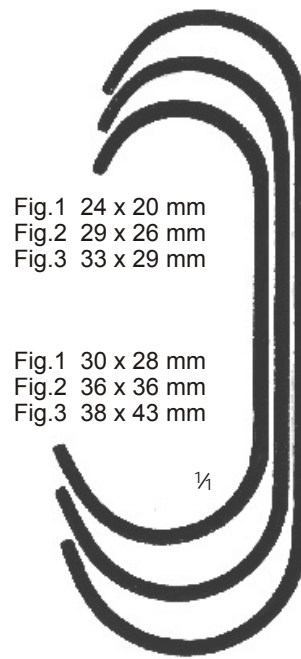

Roux

26-3170-00
Satz, set
jeu, juego

Roux

Fig.1 26-3171 14,0 cm/5½"
Fig.2 26-3172 15,0 cm/6"
Fig.3 26-3173 17,0 cm/6¾"



26-3176-01
 scharf
 sharp
 pointu
 agudo

Finsen
 5,0 cm/2"

26-3176-02
 stumpf
 blunt
 mousse
 romo

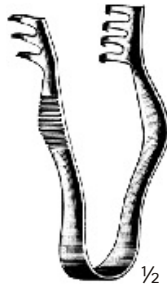

26-3177-01
 scharf
 sharp
 pointu
 agudo

Finsen
 7,0 cm/2¾"

26-3177-02
 stumpf
 blunt
 mousse
 romo

26



26-3178-01
 scharf
 sharp
 pointu
 agudo

Jansen
 10,0 cm/4"



26-3178-02
 stumpf
 blunt
 mousse
 romo

Jansen
 10,0 cm/4"



26-3179-01
 scharf
 sharp
 pointu
 agudo

Holtzheimer
 10,0 cm/4"

26-3179-02
 stumpf
 blunt
 mousse
 romo



26-3181
scharf
sharp
pointu
agudo

Weitlaner-Loktite
10,5 cm/4¼"



26-3191
stumpf
blunt
mousse
romo

Weitlaner-Loktite

26-3183
26-3186
26-3189
scharf
sharp
pointu
agudo

13,0 cm/5"
16,5 cm/6½"
20,0 cm/8"

26-3193
26-3196
26-3199
stumpf
blunt
mousse
romo



Weitlaner-Wullstein
13,0 cm/5"

26-3202-01
scharf
sharp
pointu
agudo

26-3202-02
stumpf
blunt
mousse
romo

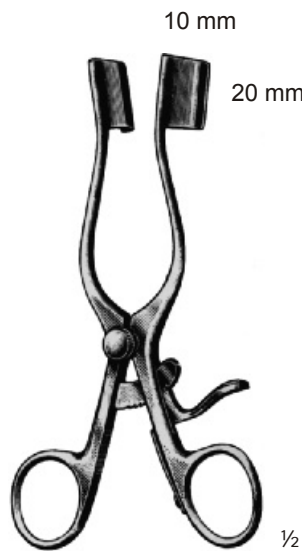

Weitlaner-Baby
13,0 cm/5"

26-3203



Scalp Contour
14,0 cm/5½"

26-3204-01
scharf
sharp
pointu
agudo

26-3204-02
stumpf
blunt
mousse
romo

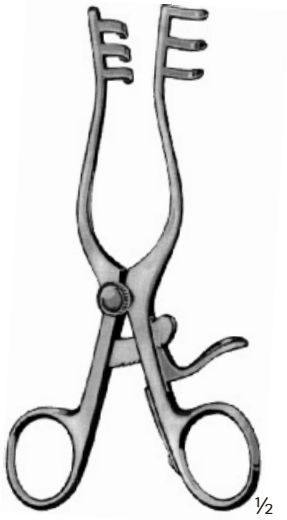

HB 3205
 stumpf
 blunt
 mousse
 romo

Milligan
 13,0 cm/5"



26-3206-01
 scharf
 sharp
 pointu
 agudo

26-3206-02
 stumpf
 blunt
 mousse
 romo

Plester
 13,0 cm/5"

26



26-3207
 stumpf
 blunt
 mousse
 romo

Plester
 11,0 cm/4¼"



26-3208
 stumpf
 blunt
 mousse
 romo

Plester
 11,0 cm/4¼"

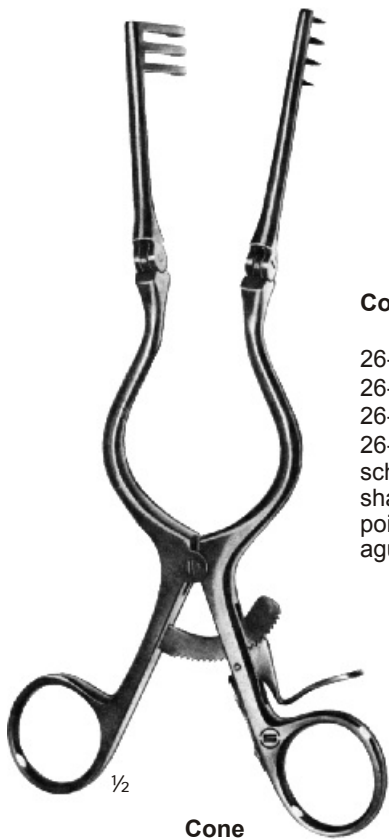

Cone

26-3210-01
26-3211-01
26-3212-01
26-3213-01
scharf
sharp
pointu
agudo

13,0 cm/5"
16,5 cm/6½"
20,0 cm/8"
25,0 cm/9½"

26-3210-02
26-3211-02
26-3212-02
26-3213-02
stumpf
blunt
mousse
romo



Tübinger Modell

26-3216
16,5 cm/6½"



Mollison
15,5 cm/6"

26-3217
scharf
sharp
pointu
agudo



Adson-Baby
16,0 cm/6¼"

26-3218
scharf
sharp
pointu
agudo

26-3219
stumpf
blunt
mousse
romo



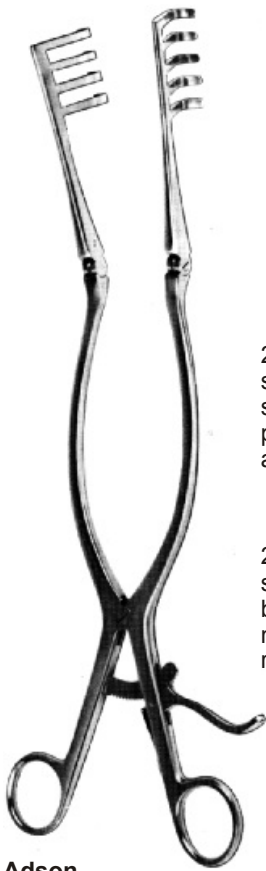

26-3220-01
 scharf
 sharp
 pointu
 agudo

26-3220-02
 stumpf
 blunt
 mousse
 romo

Adson
 32,0 cm/12½"

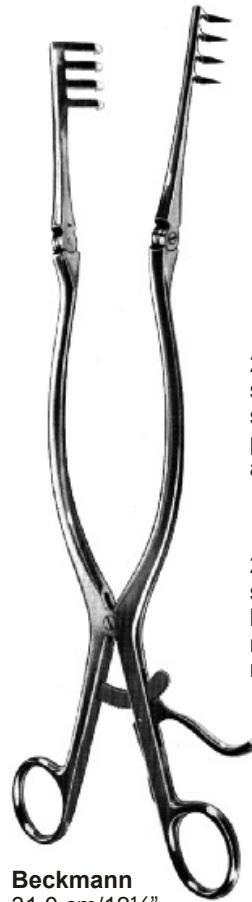

26-3221-01
 scharf
 sharp
 pointu
 agudo

26-3221-02
 stumpf
 blunt
 mousse
 romo

Beckmann
 31,0 cm/12¼"



18 mm

½

26-3222-01
 scharf
 sharp
 pointu
 agudo

26-3222-02
 stumpf
 blunt
 mousse
 romo

Adson
 20,0 cm/8"

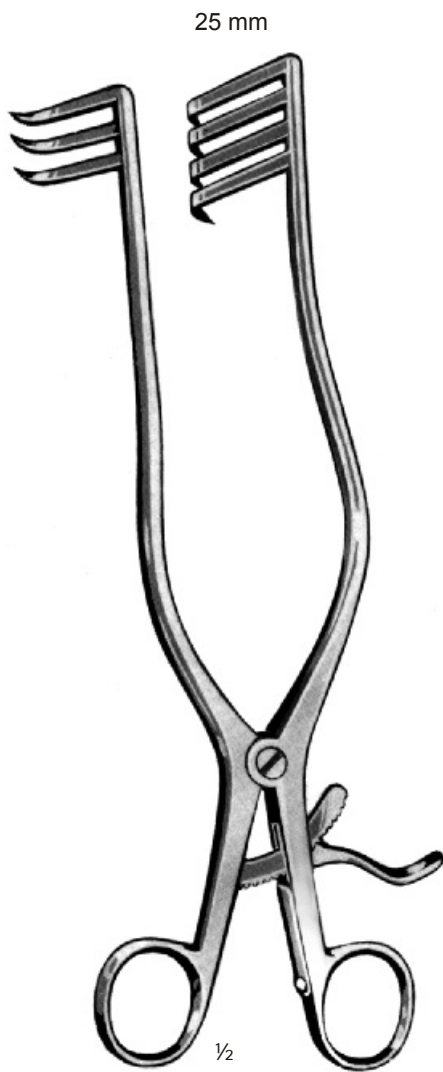

Adson
26,5 cm/10½"

26-3223-01
scharf
sharp
pointu
agudo

26-3223-02
stumpf
blunt
mousse
romo



Adson
26,5 cm/10½"

26-3224-01
scharf
sharp
pointu
agudo

26-3224-02
stumpf
blunt
mousse
romo

206



½
Beckmann-Eaton
32,0 cm/12¾"

26-3225
scharf
sharp
pointu
agudo



½
Beckmann-Adson
31,0 cm/12¼"

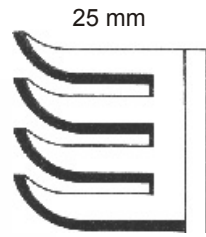

26-3226-00
stumpf
blunt
mousse
romo

26-3226-01
scharf
sharp
pointu
agudo

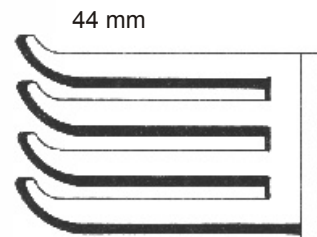

26-3226-02
stumpf
blunt
mousse
romo

26-3226-03
scharf
sharp
pointu
agudo



½
Anderson-Adson
19,5 cm/8"

26-3228
scharf
sharp
pointu
agudo

gewinkelte Arme
angular
anglé
angulado

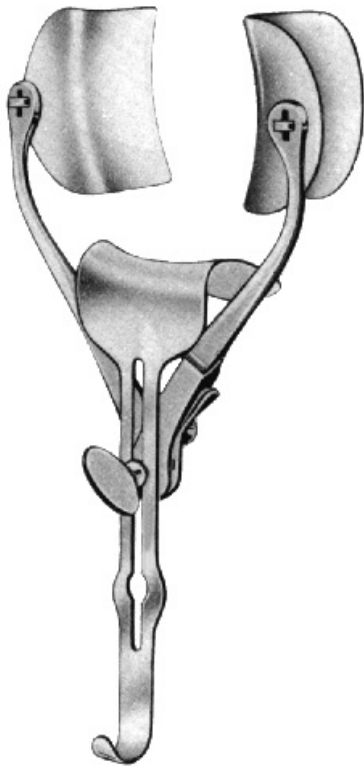

Ricard

26-3305-28
26-3305-30

280 mm	72 x 85 mm	80 x 90 mm
300 mm	60 x 80 mm	55 x 70 mm
Spreizweite	Seitliche Valven	Mittelvalve
Spread	Lateral blades	Center blade
Ecartement	Valves latérales	Valve centrale
Apertura de la hoja	Valvas laterales	Valva central



Holzbach

26-3307

62 x 80 mm	80 x 80 mm
Seitliche Valven	Mittelvalve
Lateral blades	Center blade
Valves latérales	Valve centrale
Valvas laterales	Valva central



Collin-Loktite
26,0 cm/10½"

26-3308

160 mm	60 x 80 mm	60 x 75 mm
Spreizweite	Seitliche Valven	Mittelvalve
Spread	Lateral blades	Center blade
Ecartement	Valves latérales	Valve centrale
Apertura de la hoja	Valvas laterales	Valva central



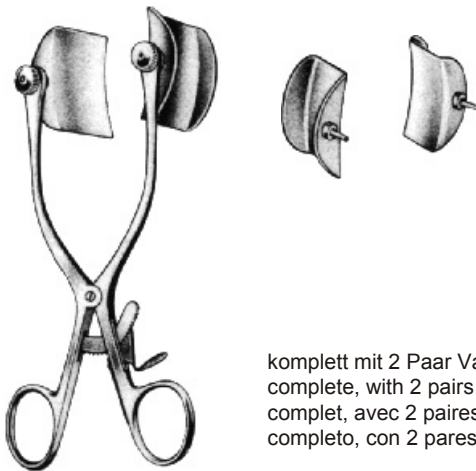

komplett mit 2 Paar Valven
complete, with 2 pairs of blades
complet, avec 2 paires de valves
completo, con 2 pares de valvas

Baby-Collin
26-3309

80 mm	27 x 40 mm
Spreizweite	18 x 40 mm
Spread	Seitliche Valven
Ecartement	Lateral blades
Apertura de la hoja	Valves latérales
	Valvas laterales



Collin
26-3310

100 mm	38 x 60 mm
Spreizweite	Seitliche Valven
Spread	Lateral blades
Ecartement	Valves latérales
Apertura de la hoja	Valvas laterales



Collin-Loktite

26-3311	100 mm	38 x 60 mm	38 x 55 mm
26-3312	100 mm	38 x 80 mm	50 x 75 mm
	Spreizweite	Seitliche Valven	Mittelvalve
	Spread	Lateral blades	Center blade
	Ecartement	Valves latérales	Valve centrale
	Apertura de la hoja	Valvas laterales	Valva central



Wechselsvalven
Exchangeable blades
Valves interchangeables
Valvas intercambiables

26-3313-18	18 x 40 mm
26-3313-27	27 x 40 mm
26-3313-38	38 x 60 mm
26-3313-40	40 x 80 mm
26-3313-45	45 x 80 mm
26-3313-60	60 x 80 mm

26



Gosset
26-3315

100 mm	30 x 40 mm
Spreizweite	Seitliche Valven
Spread	Lateral blades
Ecartement	Valves latérales
Apertura de la hoja	Valvas laterales

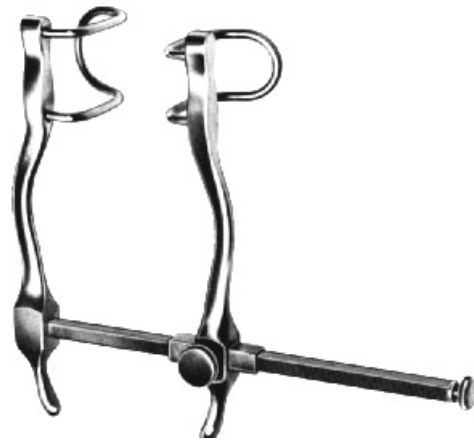

Gosset
26-3316

100 mm	30 x 40 mm
Spreizweite	Seitliche Valven
Spread	Lateral blades
Ecartement	Valves latérales
Apertura de la hoja	Valvas laterales



Gosset
26-3317

140 mm	35 x 63 mm
Spreizweite	Seitliche Valven
Spread	Lateral blades
Ecartement	Valves latérales
Apertura de la hoja	Valvas laterales



Gosset
26-3318

160 mm	35 x 63 mm	56 x 60 mm
Spreizweite	Seitliche Valven	Mittelvalve
Spread	Lateral blades	Center blade
Ecartement	Valves latérales	Valve centrale
Apertura de la hoja	Valvas laterales	Valva central

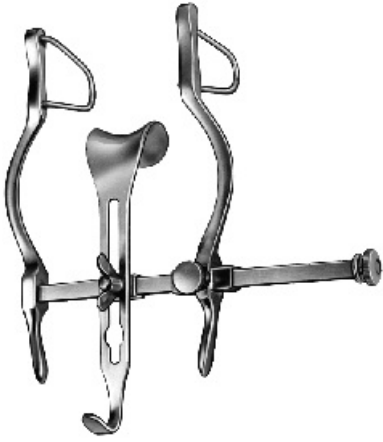

Balfour-Baby

26-3320

90 mm	26 x 38 mm	25 x 23 mm
Spreizweite	Seitliche Valven	Mittelvalve
Spread	Lateral blades	Center blade
Ecartement	Valves latérales	Valve centrale
Apertura de la hoja	Valvas laterales	Valva central



Balfour

26-3321

180 mm	35 x 70 mm	45 x 80 mm
Spreizweite	Seitliche Valven	Mittelvalve
Spread	Lateral blades	Center blade
Ecartement	Valves latérales	Valve centrale
Apertura de la hoja	Valvas laterales	Valva central

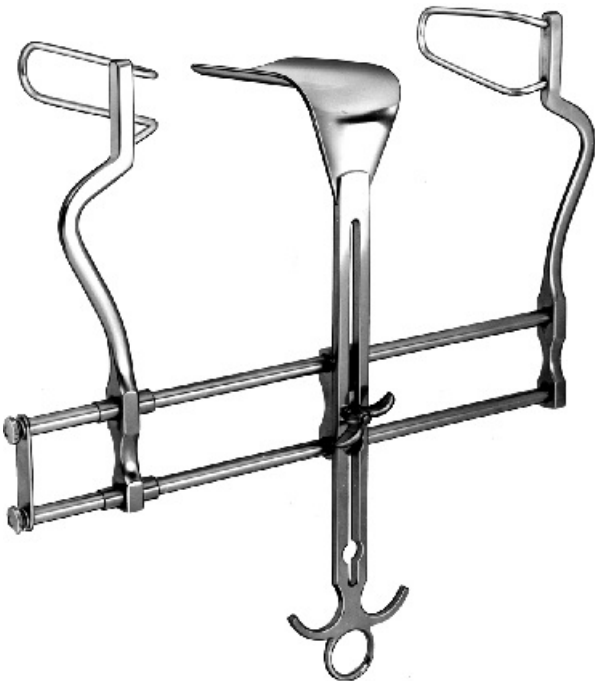

Balfour

26-3323

200 mm	35 x 100 mm	60 x 100 mm
Spreizweite	Seitliche Valven	Mittelvalve
Spread	Lateral blades	Center blade
Ecartement	Valves latérales	Valve centrale
Apertura de la hoja	Valvas laterales	Valva central

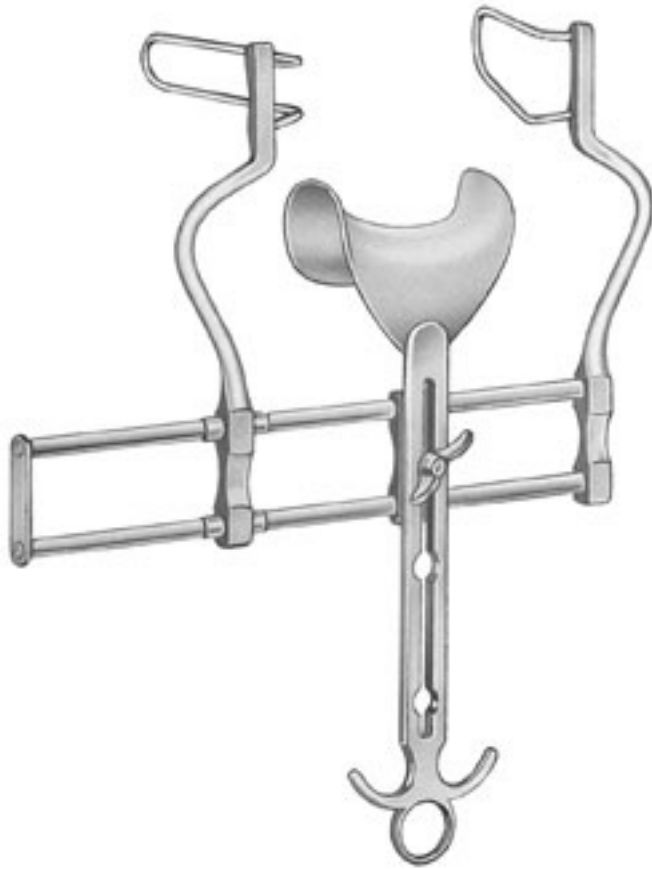

Balfour
26-3324

250 mm	35 x 100 mm	70 x 85 mm
Spreizweite	Seitliche Valven	Mittelvalve
Spread	Lateral blades	Center blade
Ecartement	Valves latérales	Valve centrale
Apertura de la hoja	Valvas laterales	Valva central



Balfour
26-3325

180 mm	35 x 70 mm	45 x 80 mm
Spreizweite	Seitliche Valven	Mittelvalve
Spread	Lateral blades	Center blade
Ecartement	Valves latérales	Valve centrale
Apertura de la hoja	Valvas laterales	Valva central

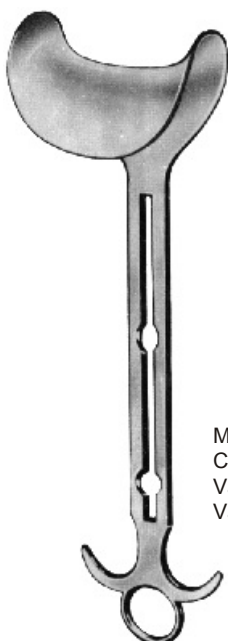

Mittelvalve allein
Center blade only
Valve centrale seule
Valva central suelta

Balfour

26-3326-01	45 x 80 mm
26-3326-02	70 x 85 mm
26-3326-03	100 x 60 mm

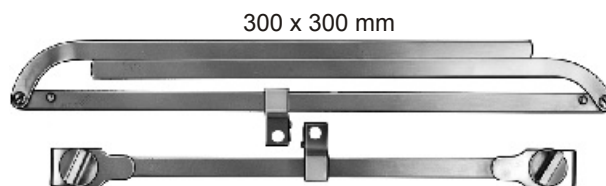
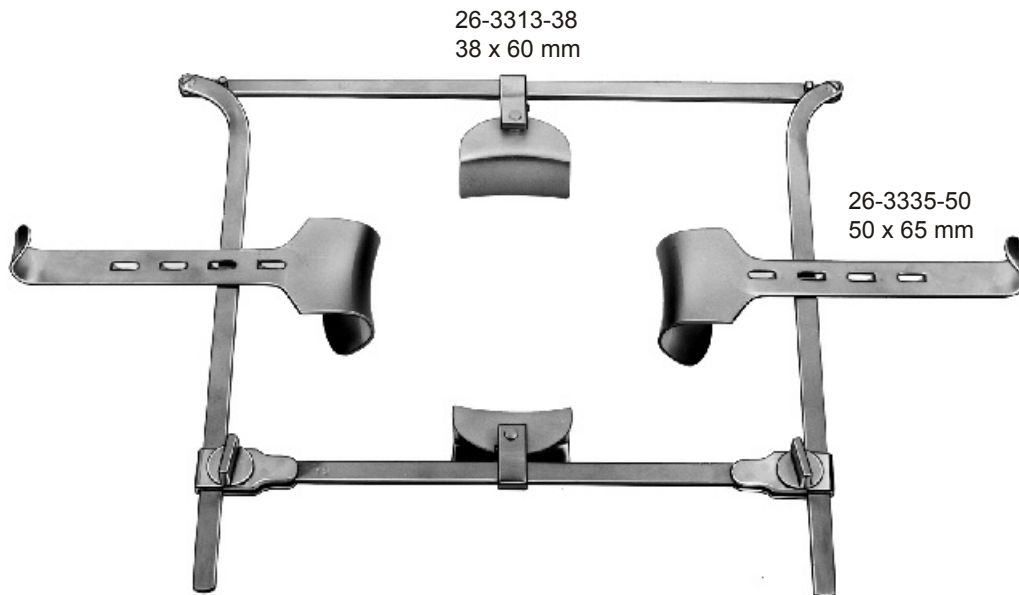

26-3330-10
Rahmen zusammenlegbar
Folding frame
Cadre pliant
Cuadro plegable

Franz			Tiefe Depth Profondeur Profundidad		Breite Width Largueur Anchura	
26-3330-00	mit 4 Valven with 4 valves avec 4 valves con 4 valvas	2x	50	x	65	mm
		2x	38	x	60	mm
26-3331-00	mit 8 Valven with 8 valves avec 8 valves con 8 valvas	2x	50	x	65	mm
		2x	38	x	60	mm
		2x	60		85	
		2x	45		80	

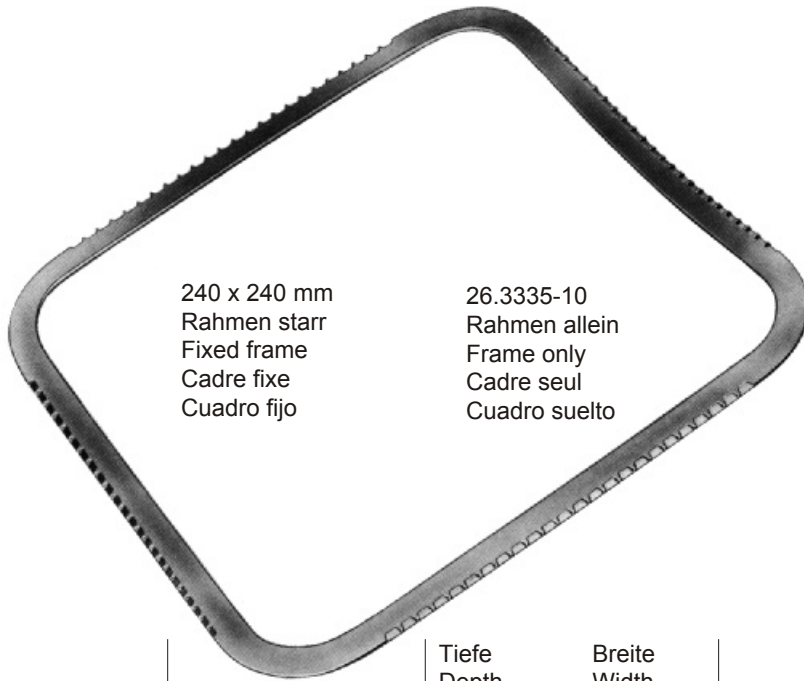

240 x 240 mm
Rahmen starr
Fixed frame
Cadre fixe
Cuadro fijo

26.3335-10
Rahmen allein
Frame only
Cadre seul
Cuadro suelto

Kirschner			Tiefe Depth Profondeur Profundidad		Breite Width Largueur Anchura	
26-3335-00	mit 4 Valven with 4 valves avec 4 valves con 4 valvas	2x 2x	40 50	x x	55 65	mm mm



Kirschner

26-3335-40 40 x 55 mm
26-3335-50 50 x 65 mm
26-3335-60 60 x 85 mm
26-3335-78 78 x 65 mm
26-3335-80 80 x 90 mm



Kirschner

26-3335-98 98 x 50 mm
26-3335-99 105 x 35 mm

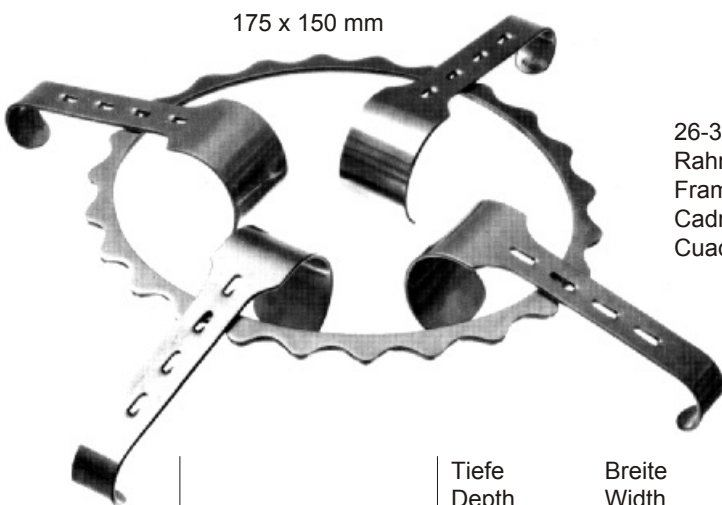

175 x 150 mm

26-3336-10
Rahmen allein
Frame only
Cadre seul
Cuadro suelto

Denis-Browne			Tiefe Depth Profondeur Profundidad		Breite Width Largueur Anchura	
26-3336-00	mit 4 Valven with 4 valves avec 4 valves con 4 valvas	2x 2x	40 40	x x	30 40	mm mm

Valven allein
Valves only
Valves seules
Valvas sueltas

Denis-Browne

26-3336-01 20 x 30 mm
26-3336-02 20 x 40 mm
26-3336-03 40 x 30 mm
26-3336-04 40 x 40 mm





26-3340-10
Rahmen allein
Frame only
Cadre seul
Cuadro suelto



O'Sullivan-O'Connor

26-3340-00

mit 3 Valven
with 3 valves
avec 3 valves
con 3 valvas

2x
1x

Tiefe
Depth
Profondeur
Profundidad

Breite
Width
Largueur
Anchura

80 x 45 mm
110 x 70 mm

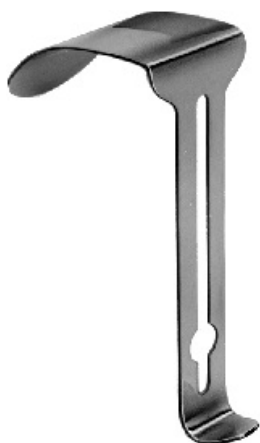

Valve allein
Valve only
Valve seule
Valva suelta

26-3340-45
80 x 45 mm



Valve allein
Valve only
Valve seule
Valva suelta

26-3340-70
110 x 70 mm



Rigby
26-3342

100 mm	70 x 16 mm
Spreizweite	Seitliche Valven
Spread	Lateral blades
Ecartement	Valves latérales
Apertura de la hoja	Valvas laterales

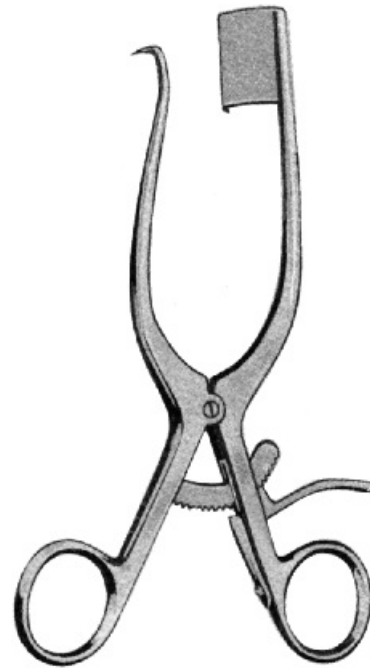

Markham-Meyerding
26-3343-01

18,0 cm/7"

83 mm	45 x 25 mm
Spreizweite	Valve rechts
Spread	Blade right side
Ecartement	Valve à droite
Apertura de la hoja	Valva a la derecha



Markham-Meyerding
26-3343-02

18,0 cm/7"

83 mm	45 x 25 mm
Spreizweite	Valve links
Spread	Blade left side
Ecartement	Valve à gauche
Apertura de la hoja	Valva a la izquierda



Meyerding

26-3344-01
26-3344-02
26-3344-03
26-3344-04

19,0 cm/7½"

25 x 30 mm
25 x 55 mm
25 x 60 mm
20 x 60 mm
Seitliche Valven
Lateral blades
Valves latérales
Valvas laterales



Gelpi-Loktite

26-3345-09 9,0 cm/3½"
26-3345-11 11,5 cm/4½"



Gelpi-Loktite

26-3345-14 14,0 cm/5½"
26-3345-18 18,0 cm/7"

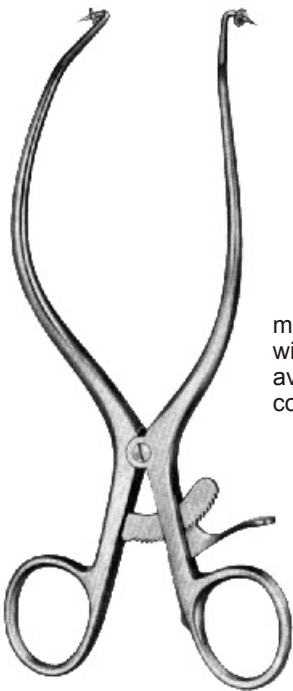

mit Kugel
with balls
avec boules
con bolas

Gelpi-Loktite

26-3346-18 18,0 cm/7"



DeBakey

26-3348 100 mm
26-3349 145 mm
Spreizweite
Spread
Ecartement
Apertura de la hoja

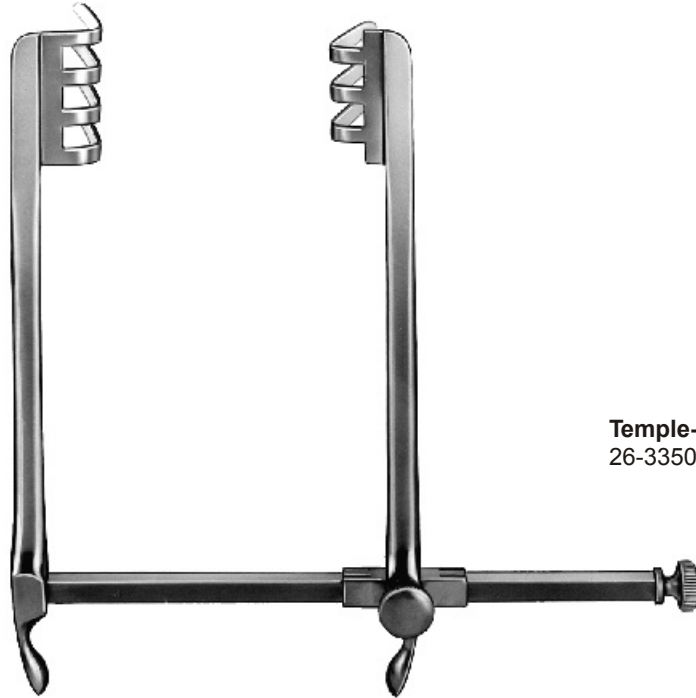

Temple-Fay
26-3350

120 mm
Spreizweite
Spread
Ecartement
Apertura de la hoja

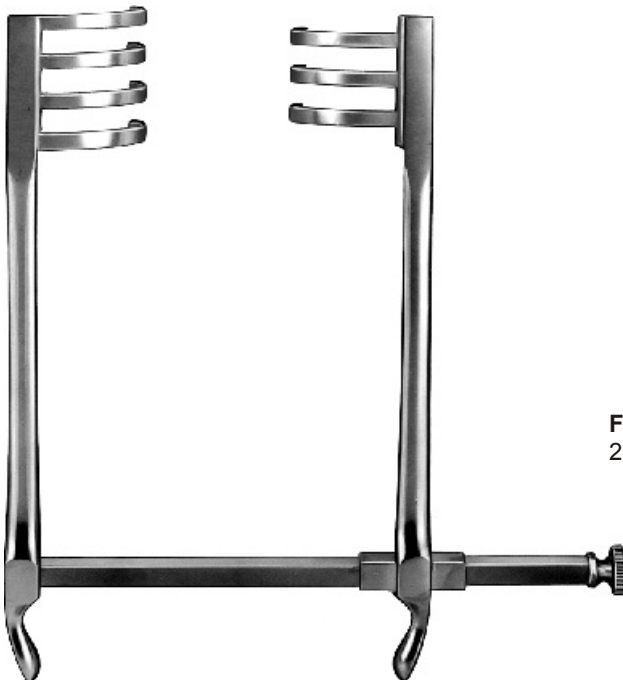

Frazier
26-3351

85 mm
Spreizweite
Spread
Ecartement
Apertura de la hoja

biegsam, flexible, malléable, flexible



26-3360	26-3361	26-3362
33,0 cm/13"	33,0 cm/13"	33,0 cm/13"
30 mm	40 mm	50 mm

biegsam, flexible, malléable, flexible

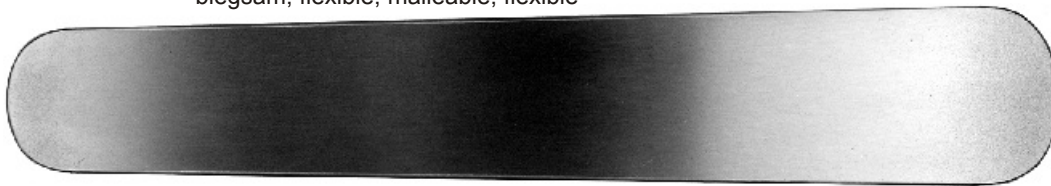

Haberer

26-3365	26-3366
28,0 cm/11"	30,0 cm/12"
25 x 30 mm	37 x 45 mm



Reverdin

26-3367
28,5 cm/11¼"
65 x 45 mm

biegsam, flexible, malléable, flexible



26-3368-06	20,0 cm/8"	6 mm	26-3368-17	20,0 cm/8"	17 mm
26-3368-09	20,0 cm/8"	9 mm	26-3368-20	20,0 cm/8"	20 mm
26-3368-12	20,0 cm/8"	12 mm	26-3368-25	20,0 cm/8"	25 mm

biegsam, flexible, malléable, flexible



Tuffier

26-3369
20,0 cm/8"
17 x 25 mm

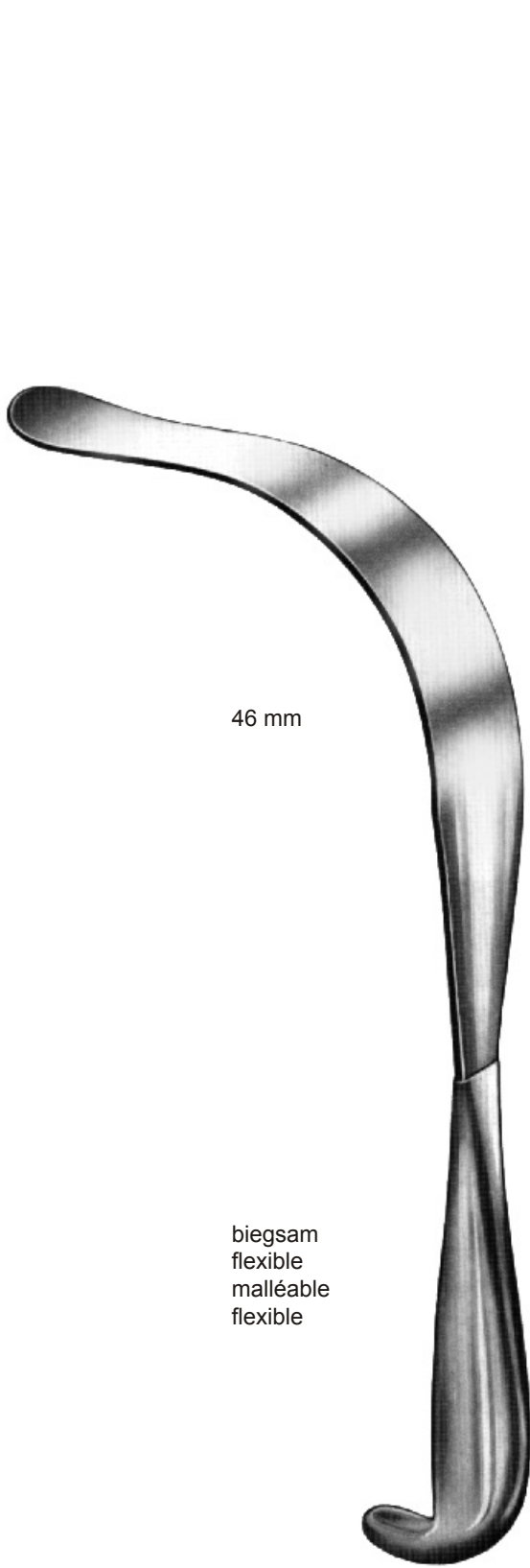

46 mm

biegsam
flexible
malléable
flexible

Kuemmel
26-3371 33,0 cm/13"



45 mm

fest
rigid
rigide
rigida



Kader
27,0 cm/10¾"

- 26-3372-20 20 mm
- 26-3372-30 30 mm
- 26-3372-40 40 mm

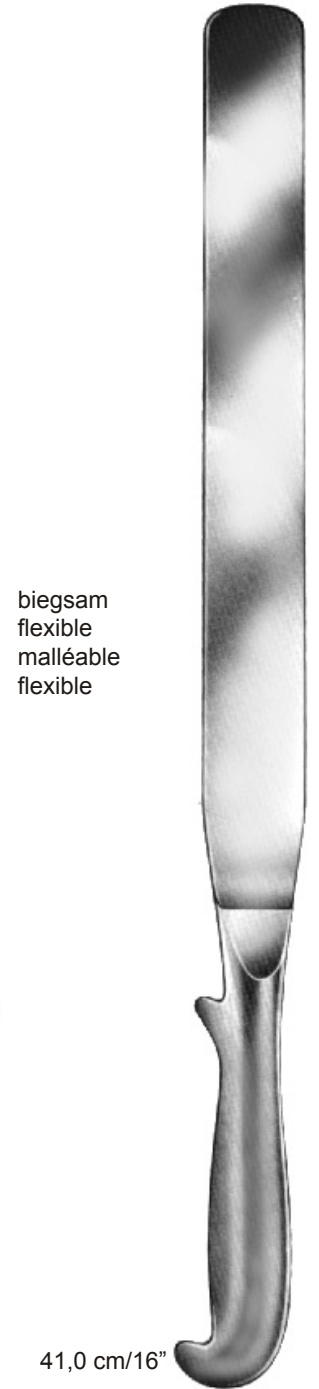

biegsam
flexible
malléable
flexible

Koerte
28,0 cm/11"

26-3375

41,0 cm/16"

- 26-3376-30 30 mm
- 26-3376-40 40 mm
- 26-3376-50 50 mm
- 26-3376-60 60 mm
- 26-3376-70 70 mm



Knochenchirurgie-Instrumente
Bone Surgery Instruments
Instrumentation pour la Chirurgie Osseuse
Instrumental para la cirugía ósea



27



Charrière

27-3400-00
35,0 cm/14"

Ersatzsägeblatt
Spare saw blade
Lame scie de rechange
Hoja de sierra de repuesto

27-3400-12 12 mm
27-3400-15 15 mm
27-3400-18 18 mm



Satterlee

27-3401-00
29,0 cm/11½"

Ersatzsägeblatt
Spare saw blade
Lame scie de rechange
Hoja de sierra de repuesto

27-3401-20



Langenbeck

27-3402
23,0 cm/9"



Charrière

27-3403-27 27,0 cm/10½"
27-3403-30 30,0 cm/12"
27-3403-34 34,0 cm/13½"

Ersatzsägeblatt
Spare saw blade
Lame scie de rechange
Hoja de sierra de repuesto

27-3403-65 15 cm
27-3403-70 20 cm
27-3403-75 25 cm

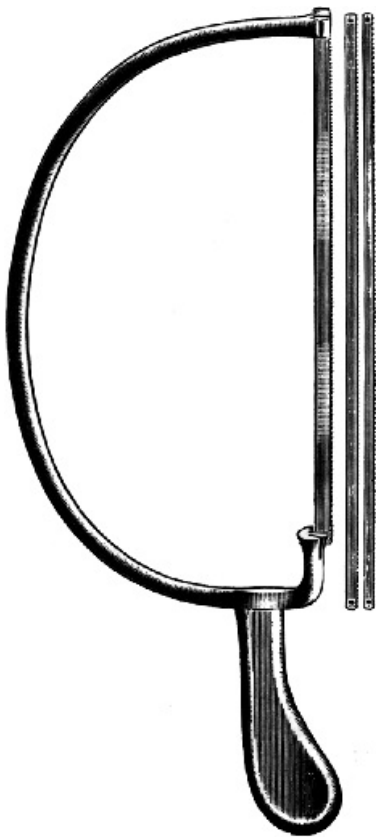

Helferich-Bier

27-3404-00
39,0 cm/15½"

Ersatzsägeblatt
Spare saw blade
Lame scie de rechange
Hoja de sierra de repuesto

27-3404-65 5 mm
27-3404-66 6 mm
27-3404-68 8 mm

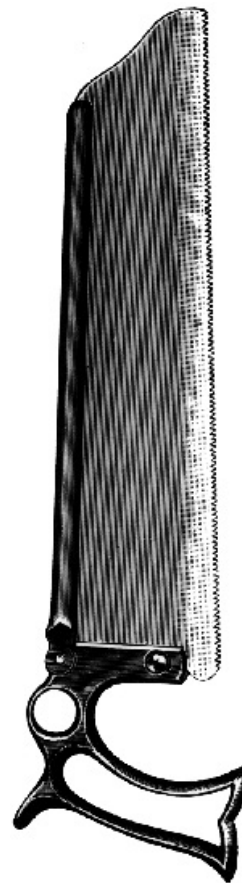

Weiss

27-3405-35
35,0 cm/14"

27

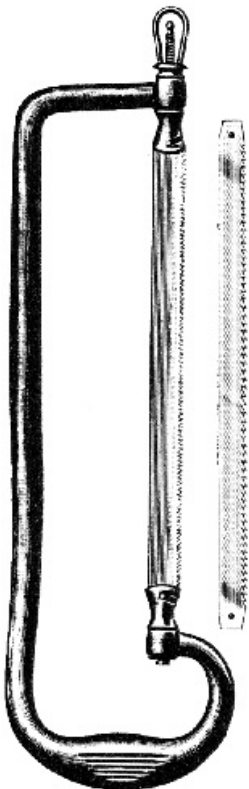

Rust

27-3406-00
24,0 cm/9½"

komplett mit je 1 Sägeblatt
12 und 18 mm
complete with saw blade
12 and 18 mm
complet avec lame de scie
12 et 18 mm
completo con hoja de sierra
12 y 18 mm

Ersatzsägeblatt
Spare saw blade
Lame scie de rechange
Hoja de sierra de repuesto

27-3406-06 6 mm
27-3406-08 8 mm
27-3406-12 12 mm
27-3406-15 15 mm
27-3406-18 18 mm

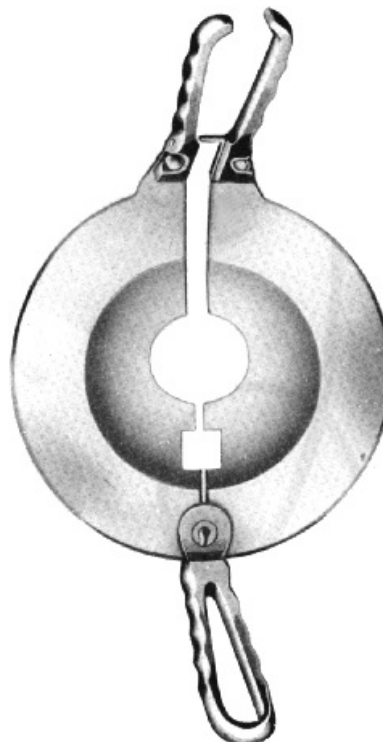

Percy

27-3408
Amputations-Retraktor
Amputating retractor
Rétracteur à amputation
Retractor para amputación

ores



27-3410-14
 14,0 cm/5½"

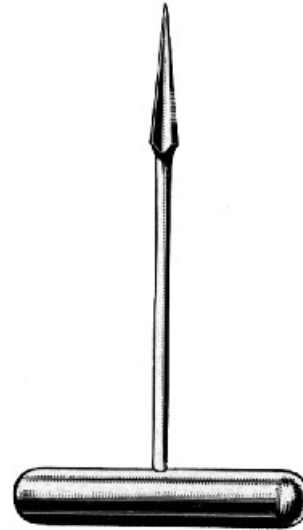

27-3411-14
 14,0 cm/5½"

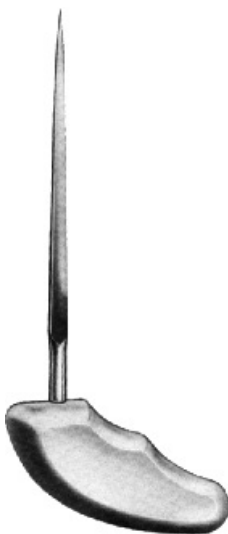

Perthes

27-3412-01 18,0 cm/7"
 27-3412-02 21,0 cm/8¼"

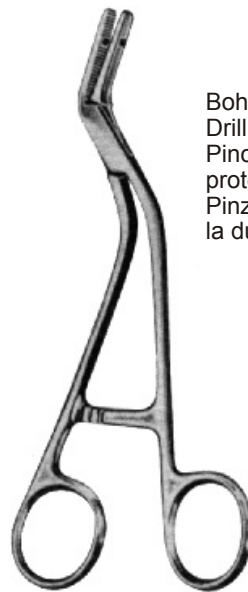

Adson

27-3413-15
 15,0 cm/6"

Bohrer-, Führungs- und Dura-Schutzzange
 Drill guide and dura protecting forceps
 Pince-guide pour des perforateurs et pour
 protéger la dure-mère
 Pinza-guía para taladros y para proteger
 la dura-madre

**transversal
versal**



Gewindeschneider mit Quergriff
Tap with cross handle
Taraud avec manche transversal
Terraaja con mango transversal



27-3420-25 2,5 mm
27-3420-35 3,5 mm

Lane

27-3421-25
25,0 cm/10"

27-3422-25
25,0 cm/10"

	Ø	
27-3428-25	2,5 mm	14,0 cm/5½"
27-3428-27	2,7 mm	14,0 cm/5½"
27-3428-30	3,0 mm	16,0 cm/6½"
27-3428-35	3,5 mm	16,0 cm/6½"
27-3428-36	3,6 mm	16,0 cm/6½"
27-3428-40	4,0 mm	18,0 cm/7¼"
27-3428-45	4,5 mm	18,0 cm/7¼"
27-3428-65	6,5 mm	22,0 cm/9"

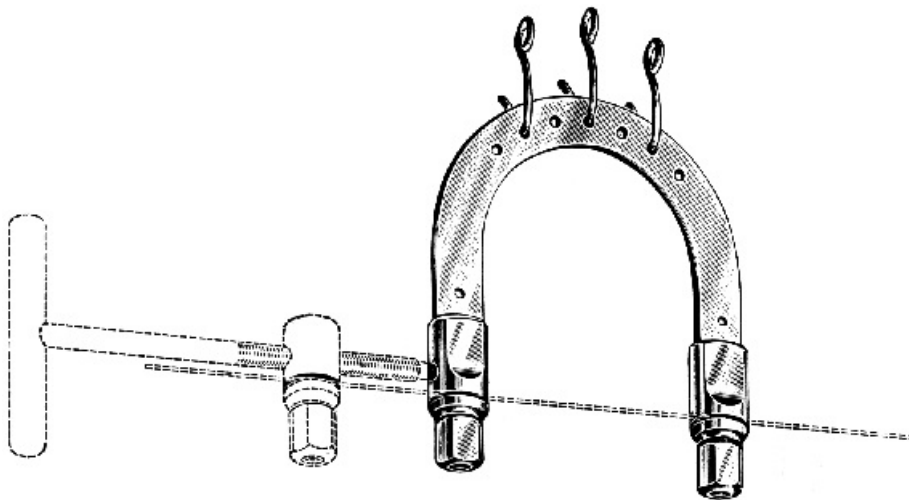

mit 3 Zughaken
with 3 traction hooks
avec 3 crochets de traction
con 3 ganchos de tracción

Kirschner

27-3430-01	9,5 x 7,0 cm
27-3430-02	10,5 x 10,5 cm
27-3430-03	12,0 x 12,0 cm
27-3430-04	15,5 x 15,5 cm
27-3430-05	20,0 x 15,5 cm

lichte Weite
clear width
largueur ouverte
anchura interior

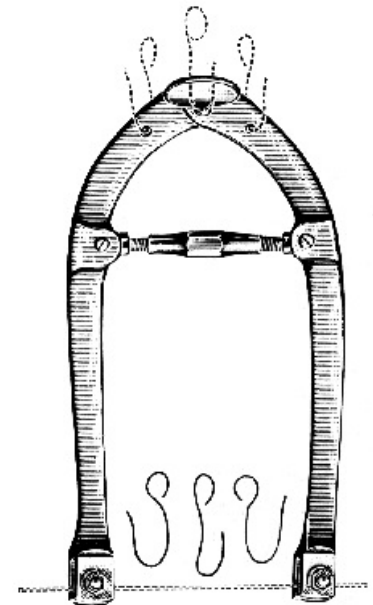

lichte Weite
clear width
largueur ouverte
anchura interior

27-3431-01	18,0 x 10,0
27-3431-02	27,0 x 16,0

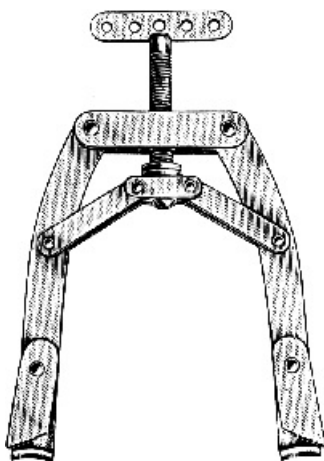

**Kirschner
(amerikanisches Modell)**

27-3432-01	27-3432-02
kleines Modell	großes Modell
small pattern	large pattern
petit modèle	modèle grand
modelo pequeño	modelo grande

mit 3 Zughaken
with 3 traction hooks
avec 3 crochets de traction
con 3 ganchos de tracción

Spannschlüssel
Wire strainer
Tendeur de broches
Tensor de taladros



27-3433-18

Mutterschlüssel
Screw nut wrench
Clé de serrage
Llave de tuercas



27-3433-19

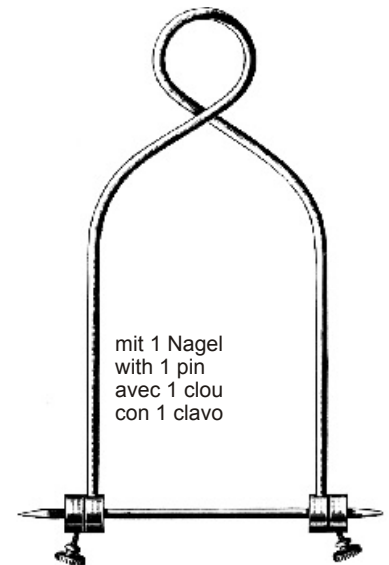

mit 1 Nagel
with 1 pin
avec 1 clou
con 1 clavo

Böhler

27-3434-01	16,0 x 9,0
27-3434-02	21,0 x 11,0

lichte Weite
clear width
largueur ouverte
anchura interior

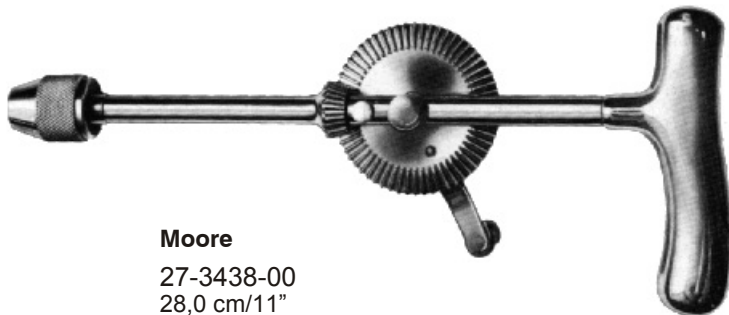

Moore
 27-3438-00
 28,0 cm/11"
 komplett
 complete
 complet
 completo



27-3438-03
 Spiralbohrer-Satz
 Set of twist drills
 Jeu de fraises
 Juego de taladros espirales

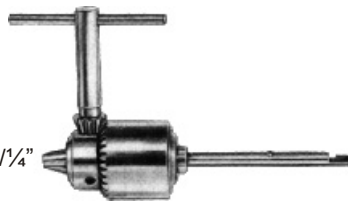

6,35 mm/¼"

Jacobs
 27-3439-00
 Dreibacken-Spannfutter
 Three-jaw-chuck
 Mandrin à trois mâchoires
 Mandril de tres mordazas

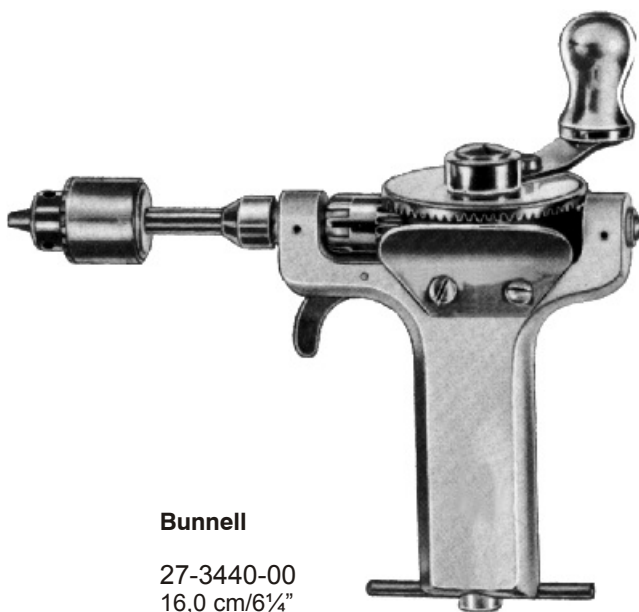

Bunnell
 27-3440-00
 16,0 cm/6¼"

27-3440-01
 Schlüssel, allein
 Wrench, only
 Clé, seule
 Llave, suelta

27



Ralk
27-3441-00



27-3441-01
Schlüssel, allein
Wrench, only
Clé, seule
Llave, suelta



Smedberg
27-3442-00



27-3442-01
Schlüssel, allein
Wrench, only
Clé, seule
Llave, suelta



27-3443-27
Griff, allein
Handle, only
Manche, seul
Mango, suelto

Hudson
27,0 cm/10½"

27-3443-00
- komplett mit Fräsern Fig. 1-4
und Verlängerungsstück Fig. 9
- complete with 4 burrs. fig. 1-4
and extension piece fig. 9
- complet avec 4 fraises, fig. 1-4
et pièce de rallonge fig. 9
- completo con 4 fresas fig. 1-4
y pieza de prolongación fig. 9



Hudson
Fig. 1
27-3443-01
Ø 9 mm



Hudson
Fig. 2
27-3443-02
Ø 14 mm



Hudson
Fig. 3
27-3443-03
Ø 16 mm



Hudson
Fig. 4
27-3443-04
Ø 22 mm



Hudson
Fig. 9
27-3443-09
Verlängerungsstück
Extension piece
Pièce de rallonge
Pieza de prolongación



Cuching
Fig. 5
27-3443-05
Ø 14 mm



Adson
Fig. 6
27-3443-06
Ø 2 mm



McKenzie
Fig. 7
27-3443-07
Ø 13 mm



Errico
Fig. 8
27-3443-08
Ø 16 mm

27

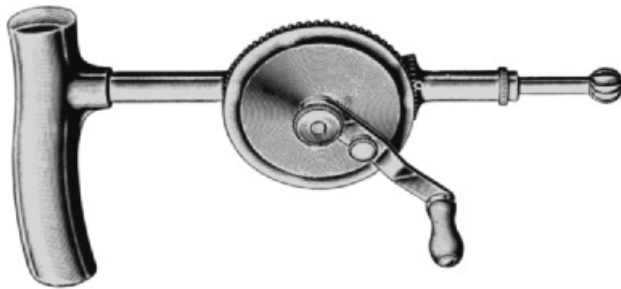

Stille
 20,0 cm/8"

27-3444-00
 komplett mit Fräsern Fig. 1-9
 complete with burrs fig. 1-9
 complet avec fraises fig. 1-9
 completo con fresas fig. 1-9



Fig. 1
 27-3444-01
 Ø 2,5 mm



Fig. 2
 27-3444-02
 Ø 3,0 mm



Fig. 3
 27-3444-03
 Ø 3,5 mm



Fig. 4
 27-3444-04
 Ø 4,0 mm



Fig. 5
 27-3444-05
 Ø 10 mm



Fig. 6
 27-3444-06
 Ø 5,0 mm



Fig. 7
 27-3444-07
 Ø 8,0 mm



Fig. 8
 27-3444-08
 Ø 12,0 mm



Fig. 9
 27-3444-09
 Ø 16,0 mm



Fig. 10
 27-3444-10
 Ø 1,0 mm



Fig. 11
 27-3444-11
 Ø 1,5 mm



Fig. 12
 27-3444-12
 Ø 2,0 mm



17,0 cm/6¾"



27-3450-01



27-3450-02

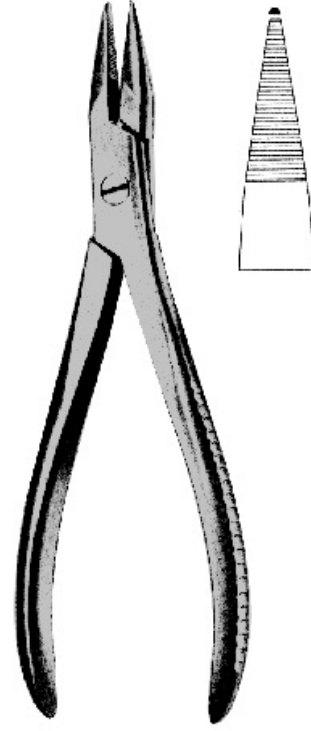

27-3451-19
 19,0 cm/7½"



27



27-3452-14
 14,0 cm/5½"

spitz
 sharp
 pointu
 agudo

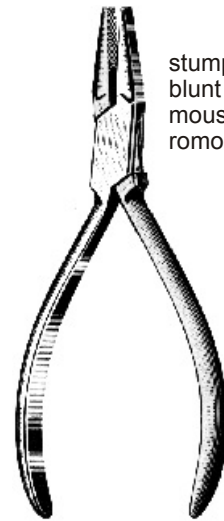

27-3453-14
 14,0 cm/5½"

stumpf
 blunt
 mousse
 romo



18,0 cm/7"



Fig. 1
27-3454-01



Fig. 2
27-3454-02



Fig. 3
27-3454-03

Flachzangen
Flat nose pliers
Pincas plates
Alicates planos



18,0 cm/7"



Fig. 4
27-3454-04



27-3455-16
16,0 cm/6¼"

Kopfschneider
Wire cutting pliers
Pincas à couper le fil
Alicates para cortar alambre



27-3456-15
15,0 cm/6"

Kopfschneider
Wire cutting pliers
Pincas à couper le fil
Alicates para cortar alambre

für harten Draht bis 1,5 mm
for hard wire up to 1,5 mm
pour fils durs jusqu'à 1,5 mm
para hilos duros hasta 1,5 mm

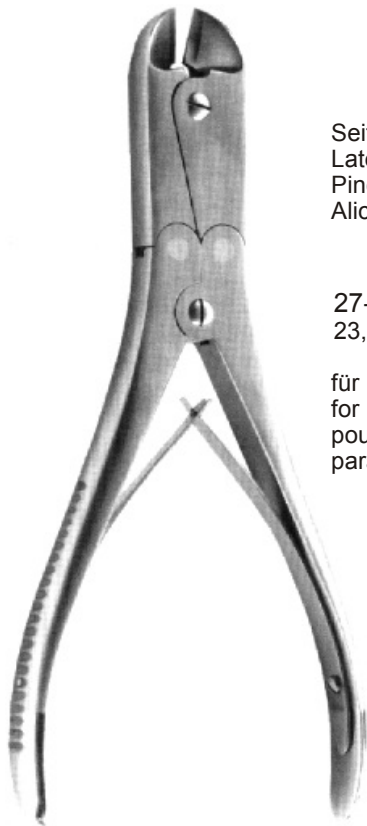

Seitenschneider
Lateral wire cutter
Pince à couper le fil à tranchant latéral
Alicates para cortar alambre con corte lateral

27-3457-23
23,0 cm/9"

für harten Draht bis 2,2 mm
for hard wire up to 2,2 mm
pour fils durs jusqu'à 2,2 mm
para hilos duros hasta 2,2 mm



Bolzenschneider
Wire cutting pliers
Pince à couper le fil
Alicates para cortar alambre

27-3459-45
45,0 cm/18"

27-3459-56
56,0 cm/22½"

für Draht bis
for wire up to
pour fils jusqu'à
para hilos hasta

6,0 mm
6,0 mm
6,0 mm
6,0 mm

7,5 mm
7,5 mm
7,5 mm
7,5 mm



Kopfschneider
Frontal wire cutting pliers
Pince à couper le fil à tranchant frontal
Alicates para cortar alambre con corte frontal

27-3458-21
21,0 cm/8¼"

für harten Draht bis 2,5 mm
for hard wire up to 2,5 mm
pour fils durs jusqu'à 2,5 mm
para hilos duros hasta 2,5 mm

27-3459-90
Ersatzbacken allein
Cutting parts only
Pièces coupantes seules
Juego de mandíbulas de repuesto

Osteotome
Osteotomes
Osteotomes
Osteotomos

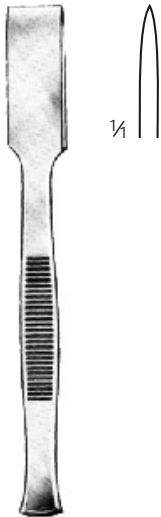

13,5 cm/5¼"

27-3460-03	3 mm
27-3460-04	4 mm
27-2460-05	5 mm
27-3460-06	6 mm
27-3460-08	8 mm
27-3460-10	10 mm
27-3460-12	12 mm
27-3460-14	14 mm
27-3460-16	16 mm

Flachmeissel
Bone chisels
Ciseaux-burins
Cinceles



13,5 cm/5¼"

27-3461-04	4 mm
27-3461-06	6 mm
27-3461-08	8 mm
27-3461-10	10 mm
27-3461-12	12 mm
27-3461-14	14 mm
27-3461-16	16 mm

Hohlmeissel
Gouges
Gouges
Gubias



13,5 cm/5¼"

27-3462-03	3 mm
27-3462-04	4 mm
27-3462-05	5 mm
27-3462-06	6 mm
27-3462-08	8 mm
27-3462-10	10 mm
27-3462-12	12 mm
27-3462-14	14 mm
27-3462-16	16 mm

Flachmeissel
Bone chisels
Ciseaux-burins
Cinceles



13,5 cm/5¼"

27-3463-02	2 mm
27-3463-03	3 mm
27-3463-04	4 mm
27-3463-05	5 mm
27-3463-06	6 mm
27-3463-07	7 mm
27-3463-08	8 mm

Partsch



17,0 cm/6¾"

27-3464-02	2 mm
27-3464-03	3 mm
27-3464-04	4 mm
27-3464-05	5 mm
27-3464-06	6 mm
27-3464-07	7 mm
27-3464-08	8 mm

Hohlmeissel
Gouges
Gouges
Gubias



13,5 cm/5¼"

27-3465-02	2 mm
27-3465-03	3 mm
27-3465-04	4 mm
27-3465-05	5 mm
27-3465-06	6 mm
27-3465-07	7 mm
27-3465-08	8 mm

Partsch

17,0 cm/6¾"

27-3466-02	2 mm
27-3466-03	3 mm
27-3466-04	4 mm
27-3466-05	5 mm
27-3466-06	6 mm
27-3466-07	7 mm
27-3466-08	8 mm



Flachmeissel
Bone chisels
Ciseaux-burins
Cinceles

1/2

Alexander
18,0 cm/7"

27-3467-04	4 mm
27-3467-06	6 mm
27-3467-08	8 mm
27-3467-10	10 mm
27-3467-12	12 mm
27-3467-14	14 mm



Hohlmeissel
Gouges
Gouges
Gubias

1/2

Alexander
18,0 cm/7"

27-3468-04	4 mm
27-3468-06	6 mm
27-3468-08	8 mm
27-3468-10	10 mm
27-3468-12	12 mm
27-3468-14	14 mm

27



1/4

12,5 cm/5"

27-3469-03	3 mm
27-3469-04	4 mm
27-3469-06	6 mm
27-3469-08	8 mm
27-3469-10	10 mm
27-3469-12	12 mm
27-3469-15	15 mm

Mini-Lambotte

Osteotome
Osteotomes
Osteotomes
Osteotomos

1/4

17,0 cm/6 3/4"

27-3470-03	3 mm
27-3470-04	4 mm
27-3470-06	6 mm
27-3470-08	8 mm
27-3470-10	10 mm
27-3470-12	12 mm
27-3470-15	15 mm

Osteotome
Osteotomes
Osteotomes
Osteotomos



Osteotome, gerade
Osteotomes, straight
Osteotomes, droits
Osteotomos, rectos

27-3471-08	8 mm
27-3471-10	10 mm
27-3471-13	13 mm
27-3471-15	15 mm
27-3471-20	20 mm
27-3471-25	25 mm
27-3471-30	30 mm
27-3471-38	38 mm
27-3471-44	44 mm
27-3471-50	50 mm

1/2

Lambotte
24,0 cm/9 1/2"



Osteotome, gebogen
Osteotomes, curved
Osteotomes, courbes
Osteotomos, curvos

27-3472-08	8 mm
27-3472-10	10 mm
27-3472-13	13 mm
27-3472-15	15 mm
27-3472-20	20 mm
27-3472-25	25 mm
27-3472-30	30 mm
27-3472-38	38 mm
27-3472-44	44 mm
27-3472-50	50 mm

1/2

Lambotte
23,0 cm/9"



Flachmeissel
Bone chisels
Ciseaux-burins
Cinceles

27-3473-04	4 mm
27-3473-06	6 mm

1/2

Lucas
16,0 cm/6 1/4"



Hohlmeissel
Gouges
Gouges
Gubias

27-3474-03	3 mm
27-3474-05	5 mm

1/2

Lucas
16,0 cm/6 1/4"



Osteotome
Osteotomes
Osteotomes
Osteotomos

27-3476-04	4 mm
27-3476-06	6 mm
27-3476-08	8 mm
27-3476-10	10 mm
27-3476-12	12 mm
27-3476-15	15 mm

1/2

Stille
16,0 cm/6 1/4"



Hohlmeissel
Gouges
Gouges
Gubias

27-3477-06	6 mm
27-3477-08	8 mm
27-3477-10	10 mm
27-3477-12	12 mm
27-3477-15	15 mm

1/2

Stille
16,0 cm/6 1/4"

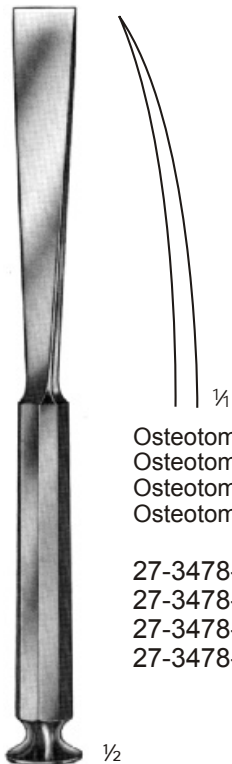

Osteotome, gebogen
Osteotomes, curved
Osteotomes, courbes
Osteotomos, curvos

27-3478-10	10 mm
27-3478-15	15 mm
27-3478-20	20 mm
27-3478-25	25 mm

1/2

Stille
20,0 cm/8"



Flachmeissel
Bone chisels
Ciseaux-burins
Cinceles

27-3479-06	6 mm
27-3479-08	8 mm
27-3479-10	10 mm
27-3479-12	12 mm
27-3479-15	15 mm
27-3479-20	20 mm
27-3479-25	25 mm
27-3479-30	30 mm

1/2

Stille
20,0 cm/8"

27



Osteotome
 Osteotomes
 Osteotomes
 Osteotomos

- | | |
|------------|-------|
| 27-3480-06 | 6 mm |
| 27-3480-08 | 8 mm |
| 27-3480-10 | 10 mm |
| 27-3480-12 | 12 mm |
| 27-3480-15 | 15 mm |
| 27-3480-20 | 20 mm |
| 27-3480-25 | 25 mm |
| 27-3480-30 | 30 mm |

Stille
 20,0 cm/8"



Hohlmeissel
 Gouges
 Gouges
 Gubias

- | | |
|------------|-------|
| 27-3481-06 | 6 mm |
| 27-3481-08 | 8 mm |
| 27-3481-10 | 10 mm |
| 27-3481-12 | 12 mm |
| 27-3481-15 | 15 mm |
| 27-3481-20 | 20 mm |
| 27-3481-25 | 25 mm |
| 27-3481-30 | 30 mm |

Stille
 20,0 cm/8"



Osteotome, gerade
 Osteotomes, straight
 Osteotomes, droits
 Osteotomos, rectos

- | | |
|------------|-------|
| 27-3482-06 | 6 mm |
| 27-3482-09 | 9 mm |
| 27-3482-13 | 13 mm |
| 27-3482-16 | 16 mm |
| 27-3482-19 | 19 mm |
| 27-3482-25 | 25 mm |
| 27-3482-32 | 32 mm |

Smith-Petersen
 20,0 cm/8"

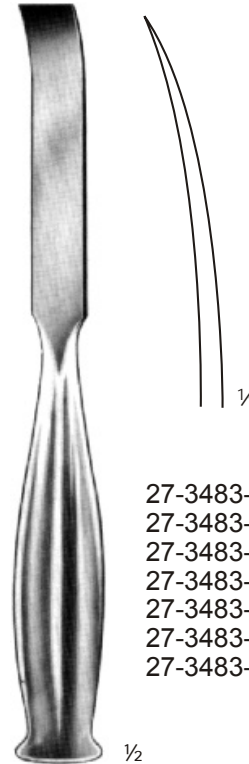

Osteotome, gebogen
 Osteotomes, curved
 Osteotomes, courbes
 Osteotomos, curvos

- | | |
|------------|-------|
| 27-3483-06 | 6 mm |
| 27-3483-09 | 9 mm |
| 27-3483-13 | 13 mm |
| 27-3483-16 | 16 mm |
| 27-3483-19 | 19 mm |
| 27-3483-25 | 25 mm |
| 27-3483-32 | 32 mm |

Smith-Petersen
 20,0 cm/8"



Hohlmeissel, gerade
 Bone chisels, straight
 Ciseaux-burins, droits
 Cinceles, rectos

- 27-3484-06 6 mm
- 27-3484-09 9 mm
- 27-3484-13 13 mm
- 27-3484-16 16 mm
- 27-3484-19 19 mm
- 27-3484-25 25 mm
- 27-3484-32 32 mm

½

Smith-Petersen
 20,0 cm/8"



Hohlmeissel, gebogen
 Bone chisels, curved
 Ciseaux-burins, courbes
 Cinceles, curvos

- 27-3485-06 6 mm
- 27-3485-09 9 mm
- 27-3485-13 13 mm
- 27-3485-16 16 mm
- 27-3485-19 19 mm
- 27-3485-25 25 mm
- 27-3485-32 32 mm

½

Smith-Petersen
 20,0 cm/8"

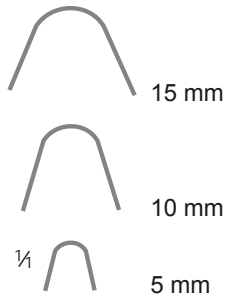

¼

Hohlmeissel, gerade
 Bone chisels, straight
 Ciseaux-burins, droits
 Cinceles, rectos

- 27-3486-05 5 mm
- 27-3486-10 10 mm
- 27-3486-15 15 mm

½

Lexer
 25,0 cm/10"

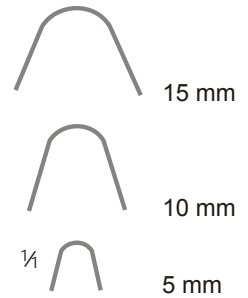

¼

Hohlmeissel, gebogen
 Bone chisels, curved
 Ciseaux-burins, courbes
 Cinceles, curvos

- 27-3487-05 5 mm
- 27-3487-10 10 mm
- 27-3487-15 15 mm

½

Lexer
 25,0 cm/10"

27

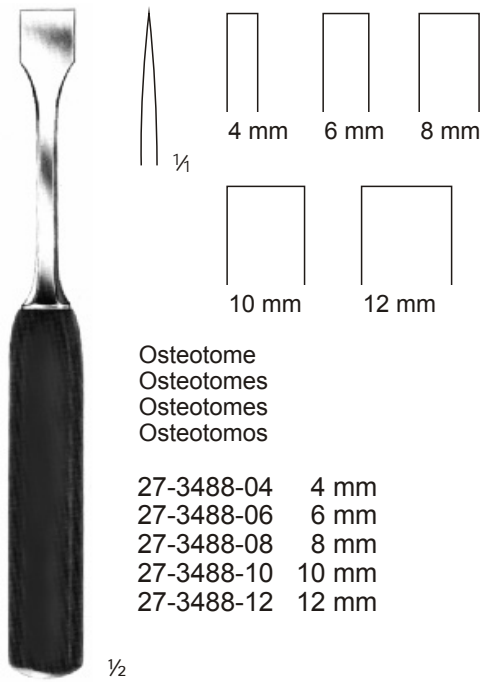

Osteotome
Osteotomes
Osteotomes
Osteotomos

- 27-3488-04 4 mm
- 27-3488-06 6 mm
- 27-3488-08 8 mm
- 27-3488-10 10 mm
- 27-3488-12 12 mm

1/2

Mini-Lexer
18,0 cm/7"

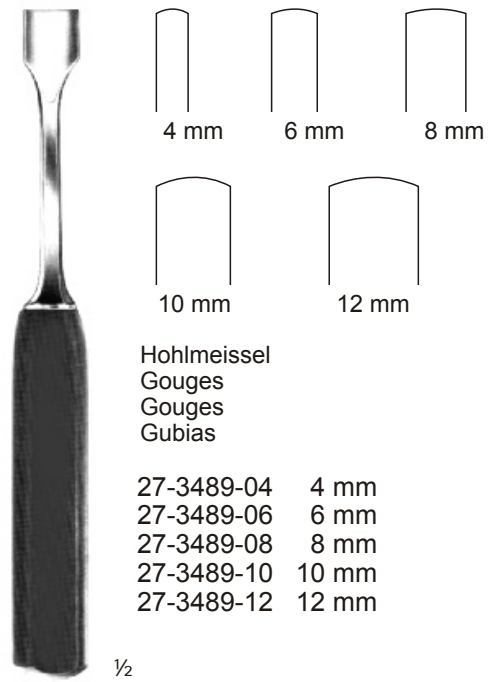

Hohlmeissel
Gouges
Gouges
Gubias

- 27-3489-04 4 mm
- 27-3489-06 6 mm
- 27-3489-08 8 mm
- 27-3489-10 10 mm
- 27-3489-12 12 mm

1/2

Mini-Lexer
18,0 cm/7"



Osteotome
Osteotomes
Osteotomes
Osteotomos

- 27-3490-05 5 mm
- 27-3490-07 7 mm
- 27-3490-10 10 mm
- 27-3490-15 15 mm
- 27-3490-20 20 mm
- 27-3490-25 25 mm
- 27-3490-30 30 mm

1/2

Lexer
22,0 cm/8 3/4"

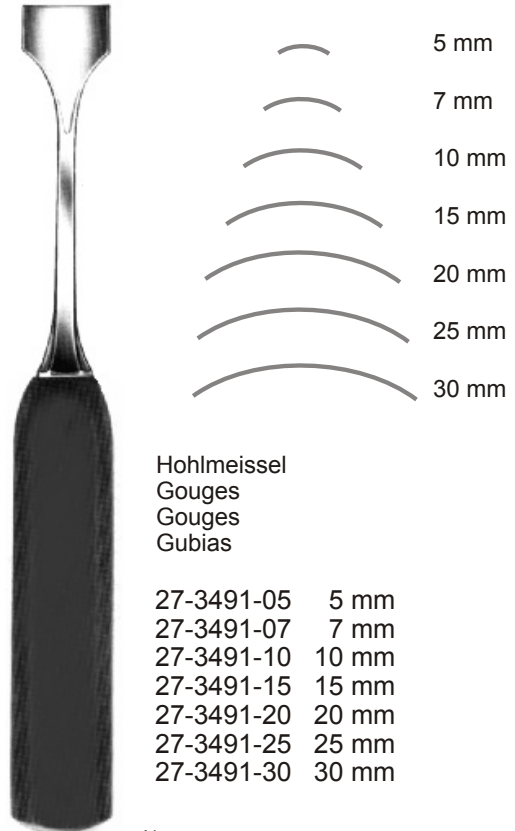

Hohlmeissel
Gouges
Gouges
Gubias

- 27-3491-05 5 mm
- 27-3491-07 7 mm
- 27-3491-10 10 mm
- 27-3491-15 15 mm
- 27-3491-20 20 mm
- 27-3491-25 25 mm
- 27-3491-30 30 mm

1/2

Lexer
22,0 cm/8 3/4"

Osteotome, gerade
Osteotomes, straight
Osteotomes, droits
Osteotomos, rectos



- 27-3492-03 3 mm
- 27-3492-05 5 mm
- 27-3492-06 6 mm
- 27-3492-08 8 mm
- 27-3492-09 9 mm

Hoke
17,0 cm/6¾"

Osteotome, gerade
Osteotomes, straight
Osteotomes, droits
Osteotomos, rectos



- 27-3493-06 6 mm
- 27-3493-13 13 mm
- 27-3493-19 19 mm
- 27-3493-25 25 mm
- 27-3493-32 32 mm

Hibbs
24,0 cm/9½"

Flachmeissel, gerade
Bone chisels, straight
Ciseaux-burins, droits
Cinceles, rectos



- 27-3494-06 6 mm
- 27-3494-13 13 mm
- 27-3494-19 19 mm
- 27-3494-25 25 mm
- 27-3494-32 32 mm

Hibbs
24,0 cm/9½"

27

Osteotome
Osteotomes
Osteotomes
Osteotomos



27-3495-06 6 mm
27-3495-13 13 mm
27-3495-19 19 mm
27-3495-25 25 mm
27-3495-32 32 mm

1/2

Hibbs
24,0 cm/9 1/2"

Hohlmeissel
Gouges
Gouges
Gubias



27-3496-06 6 mm
27-3496-13 13 mm
27-3496-19 19 mm
27-3496-25 25 mm
27-3496-32 32 mm

1/2

Hibbs
24,0 cm/9 1/2"

Hohlmeissel
Gouges
Gouges
Gubias



27-3497-06 6 mm
27-3497-13 13 mm
27-3497-19 19 mm
27-3497-25 25 mm
27-3497-32 32 mm

1/2

Hibbs
24,0 cm/9 1/2"

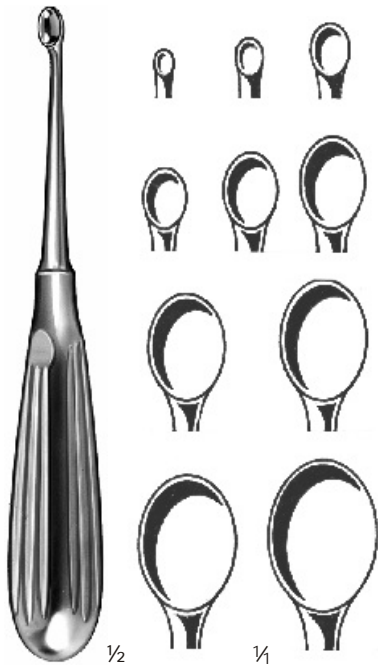

Volkmann
17,0 cm/6¾"

	Fig.	mm
27-3500	0000	3,0
27-3501	000	4,0
27-3502	00	5,0
27-3503	0	6,0
27-3504	1	7,0
27-3505	2	8,0
27-3506	3	10,0
27-3507	4	11,6
27-3508	5	12,6
27-3509	6	13,8

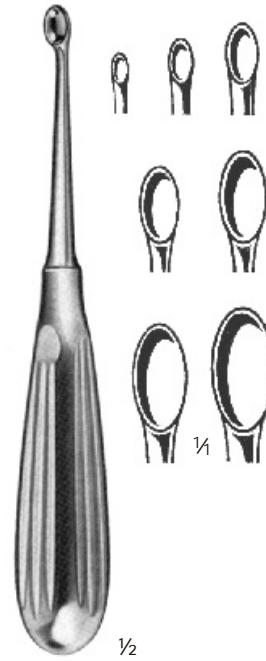

Schede
17,0 cm/6¾"

	Fig.	mm
27-3510	000	3,0
27-3511	00	4,0
27-3512	0	5,0
27-3513	1	6,0
27-3514	2	6,5
27-3515	3	7,5
27-3516	4	8,5

27

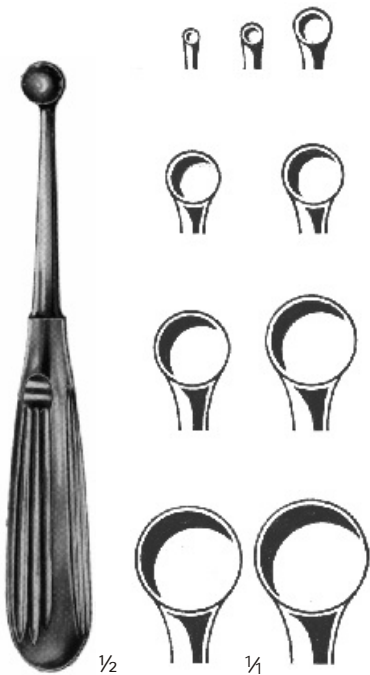

Bruns
17,0 cm/6¾"

	Fig.	mm
27-3520	000	3,0
27-3521	00	4,0
27-3522	0	5,0
27-3523	1	6,0
27-3524	2	8,0
27-3525	3	10,0
27-3526	4	12,0
27-3527	5	13,0
27-3528	6	14,0

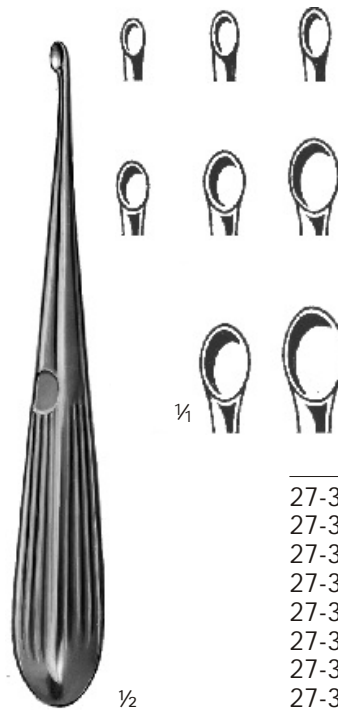

Spratt
17,0 cm/6¾"

	Fig.	mm
27-3530	000	3,0
27-3531	00	4,0
27-3532	0	4,5
27-3533	1	5,0
27-3534	2	6,0
27-3535	3	7,0
27-3536	4	8,5
27-3537	5	9,5



Williger
17,0 cm/6¾"

	Fig.	mm
27-3538-20	00	2,0
27-3538-10	0	2,5
27-3538-01	1	3,5
27-3538-02	2	5,0



Bruns
23,0 cm/9"

	Fig.	mm
27-3540	000	2,0
27-3541	00	2,5
27-3542	0	3,3
27-3543	1	3,8
27-3544	2	4,8
27-3545	3	5,3
27-3546	4	6,0
27-3547	5	6,7
27-3548	6	7,3

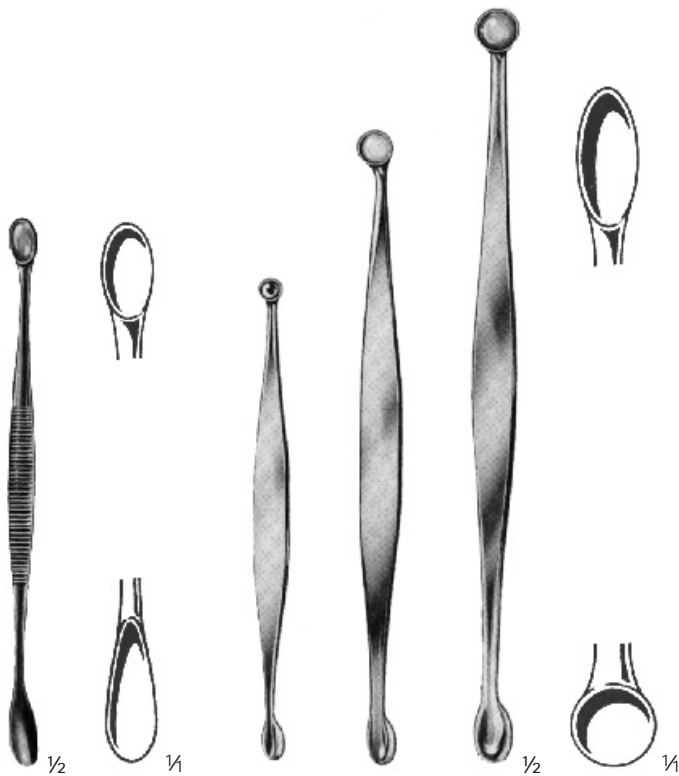

Volkman
27-3550 - 27-3552

Volkman
27-3555 - 27-3557

Länge Length Longueur Largo cm in.	oval/oval oval/oval ovale/ovale ovalada/ovalada	oval/rund oval/round ovale/ronde ovalada/redonda
13,0 5	27-3550 7,5/6,3 mm	27-3555 6,3/6,8 mm
14,5 5¾	27-3551 6,8/5,8 mm	
16,0 6¼		27-3556 7,0/9,0 mm
17,0 6¾	27-3552 6,8/7,3 mm	
20,0 8		27-3557 9,1/11,1 mm

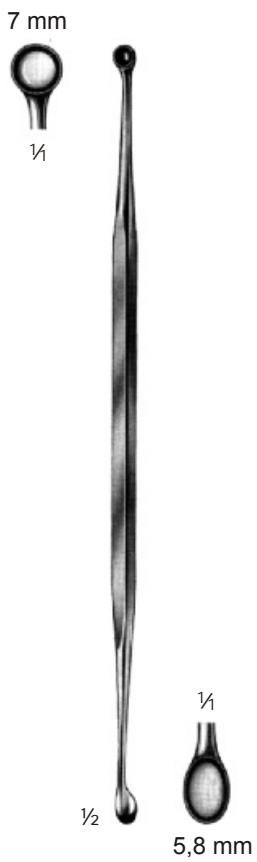

27-3558
 21,0 cm/8 1/4"



Williger
 13,5 cm/5 1/4"

	Fig.
27-3561	0/00
27-3562	0/1
27-3563	1/2

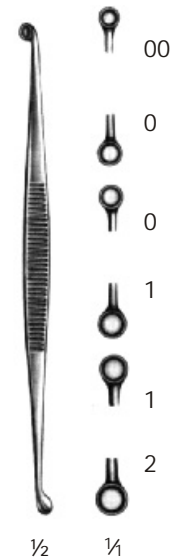

Martini
 13,5 cm/5 1/4"

	Fig.
27-3571	0/00
27-3572	0/1
27-3573	1/2

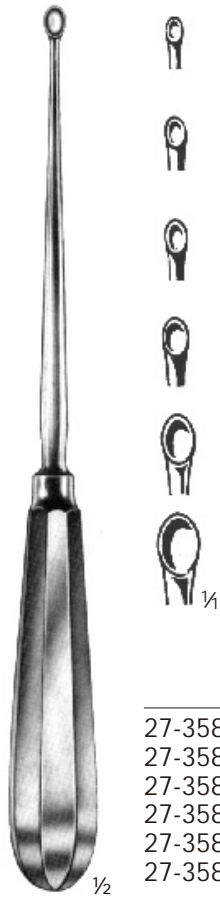

Simon
24,0 cm/9½"

	Fig.	mm
27-3581-01	1	2,2
27-3581-02	2	2,8
27-3581-03	3	3,3
27-3581-04	4	3,7
27-3581-05	5	4,5
27-3581-06	6	4,8



Daubenspeck
20,0 cm/8"

	Fig.	mm
27-3582-20	00	2,8
27-3582-10	0	3,8
27-3582-01	1	5,0
27-3582-02	2	6,0

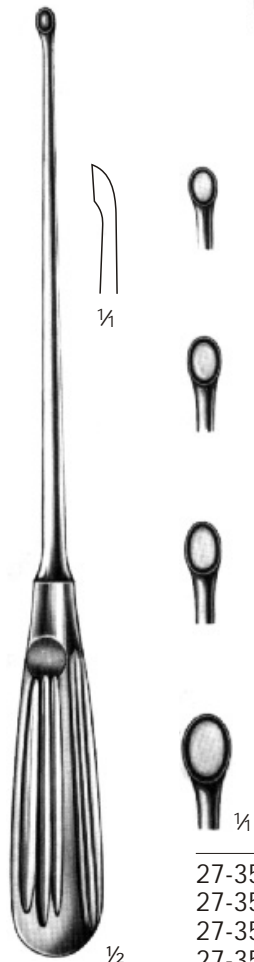

25,0 cm/10"

	Fig.	mm
27-3583-30	000	3,6
27-3583-20	00	4,4
27-3583-10	0	5,2
27-3583-01	1	6,0



25,0 cm/10"

	Fig.	mm
27-3584-30	000	3,6
27-3584-20	00	4,4
27-3584-10	0	5,2
27-3584-01	1	6,0

27



	Fig.	mm
27-3585-00	0	5
27-3585-01	1	6
27-3585-02	2	6,5
27-3585-03	3	7
27-3585-04	4	8,5

Volkmann
27,0 cm/10³/₄"

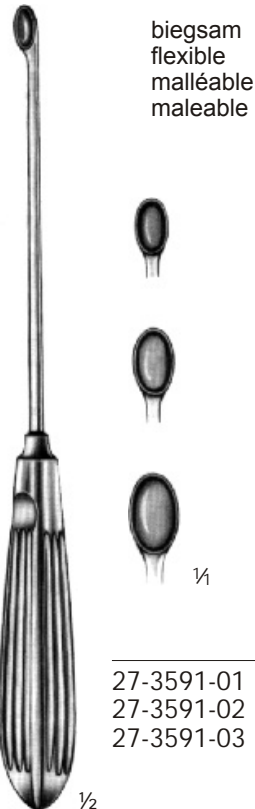

	Fig.	mm
27-3591-01	1	4,8
27-3591-02	2	5,8
27-3591-03	3	6,8

Halle
21,0 cm/8¹/₄"

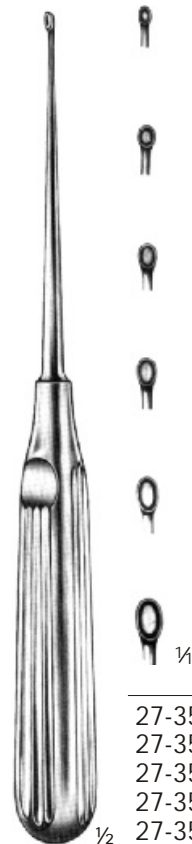

	Fig.	mm
27-3594-01	1	1,7
27-3594-02	2	2,0
27-3594-03	3	2,4
27-3594-04	4	2,7
27-3594-05	5	3,0

Lempert
21,5 cm/8¹/₂"



gerade
straight
droit
recta

Spinal
20,0 cm/8"

Spratt
23,0 cm/9"



gebogen
curved
courbe
curva

Spinal
20,0 cm/8"

Spratt
23,0 cm/9"

¼



Fig.

000

00

0

1

2

3

4

5

6

gerade
straight
droit
recta

20,0 cm/8"

23,0 cm/9"

gebogen
curved
courbe
curva

20,0 cm/8"

23,0 cm/9"

27-3595 -30	27-3595 -20	27-3595 -10	27-3595 -01	27-3595 -02	27-3595 -03	27-3595 -04	27-3595 -05	27-3595 -06
27-3596 -30	27-3596 -20	27-3596 -10	27-3596 -01	27-3596 -02	27-3596 -03	27-3596 -04	27-3596 -05	27-3596 -06
27-3597 -30	27-3597 -20	27-3597 -10	27-3597 -01	27-3597 -02	27-3597 -03	27-3597 -04	27-3597 -05	27-3597 -06
27-3598 -30	27-3598 -20	27-3598 -10	27-3598 -01	27-3598 -02	27-3598 -03	27-3598 -04	27-3598 -05	27-3598 -06



Langenbeck
27-3600
19,0 cm/7½"



Langenbeck
27-3601
18,0 cm/7"



Sedillot
27-3602
21,0 cm/8¼"



27-3603-01
14,0 cm/5½"



27-3603-02
14,0 cm/5½"



Farabeuf
27-3604
15,0 cm/6"

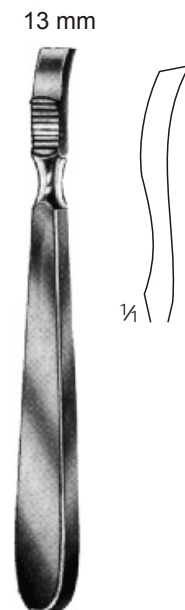

Farabeuf
27-3605
15,0 cm/6"

27



10 mm
15 mm
20 mm
25 mm



27-3606-10 10 mm
27-3606-15 15 mm
27-3606-20 20 mm
27-3606-25 25 mm

Lambotte
21,0 cm/8¼"

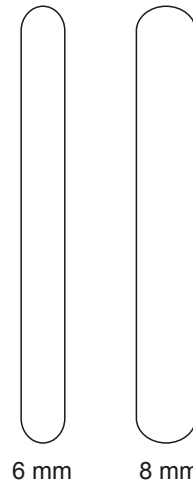

27-3607-06 6 mm
27-3607-08 8 mm
17,0 cm/6¾"



5 mm

Williger

27-3608
13,0 cm/5"



6 mm

Williger

27-3609
16,0 cm/6¼"



Howarth

27-3610
21,5 cm/8½"



8 mm

27-3611-08



17 mm

27-3611-17



Wagner
33,0 cm/13"



Alexander

27-3612
20,0 cm/8"



Matson

27-3613
22,0 cm/8¾"



6 mm
12 mm
19 mm
25 mm

leicht gebogen
slightly curved
courbe légèrement
curva ligeramente

27-3614-06 6 mm
27-3614-12 12 mm
27-3614-19 19 mm
27-3614-25 25 mm

Key
19,0 cm/7½"



27-3615

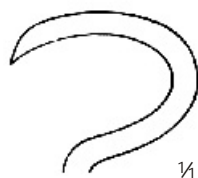

27-3617

rechts gebogen
curved to the right
courbe à droite
curva a la derecha



Doyen
17,0 cm/6¾"

Doyen
17,0 cm/6¾"



27-3616



27-3618

links gebogen
curved to the left
courbe à gauche
curva a la izquierda



Semb

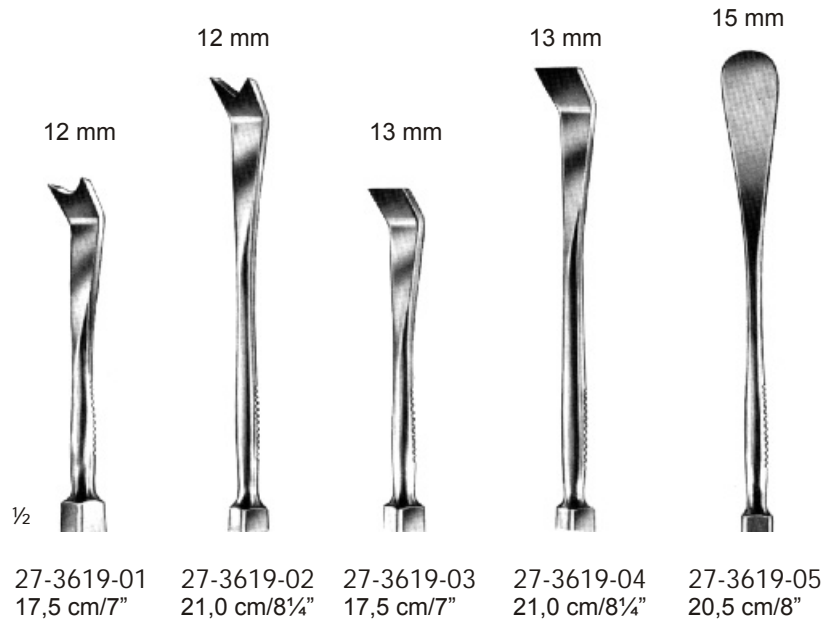

Hylin

27-3620
14,5 cm/6"

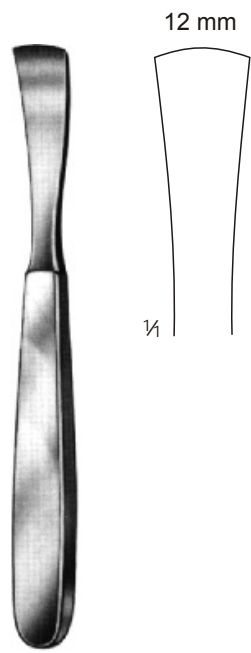

Jansen

27-3621
17,0 cm/6 3/4"

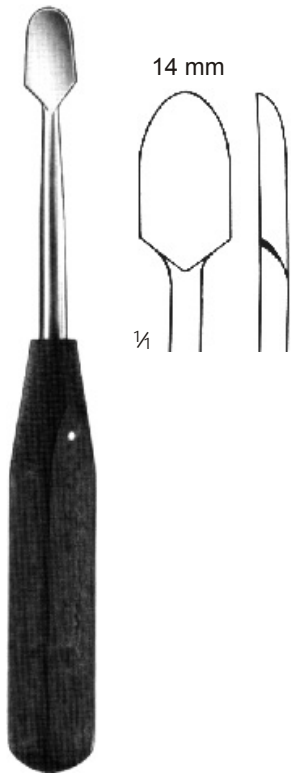

27-3622-01
 20,0 cm/8"

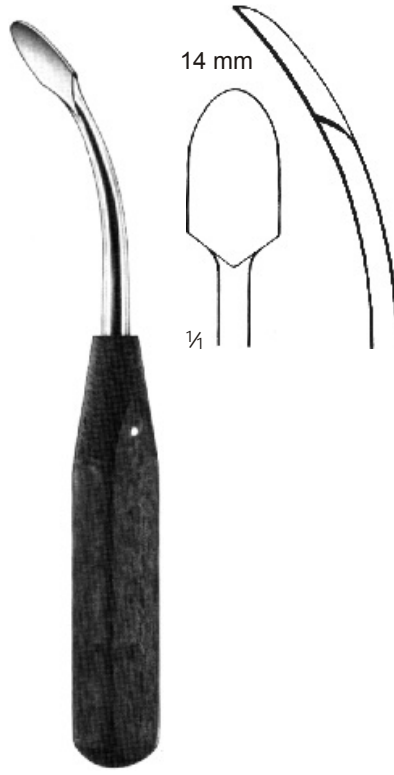

27-3622-02
 20,0 cm/8"

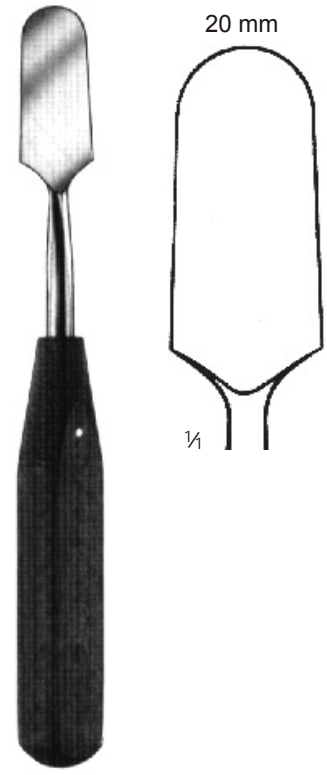

27-3622-03
 20,0 cm/8"

27

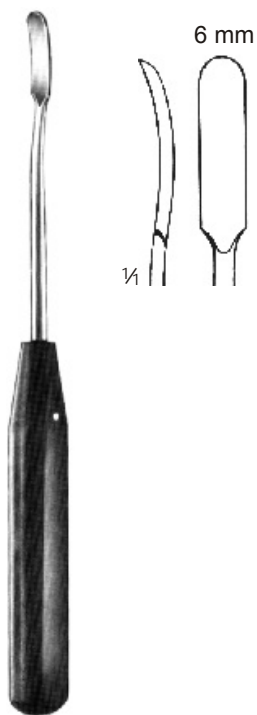

27-3623
 18,0 cm/7"

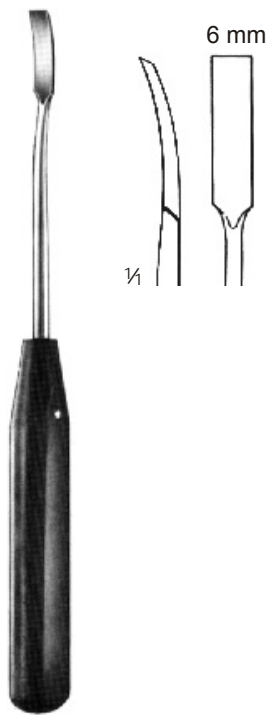

27-3624
 18,0 cm/7"

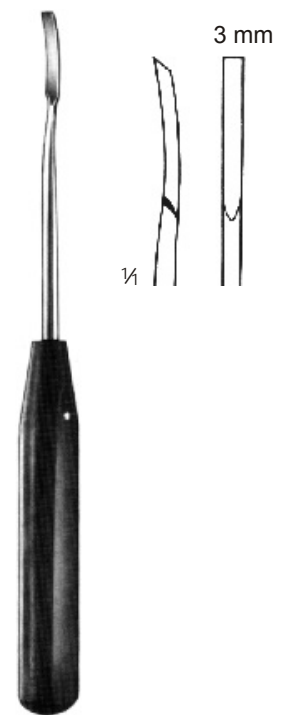

27-3625
 18,0 cm/7"

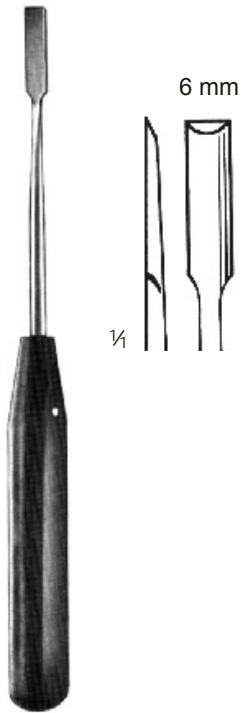

27-3626
 19,0 cm/7½"

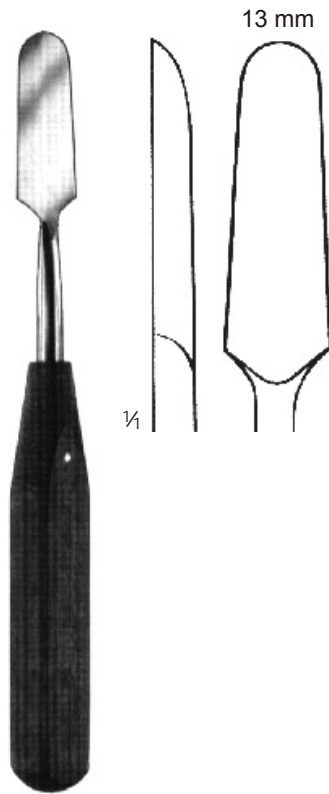

27-3627
 20,0 cm/8"

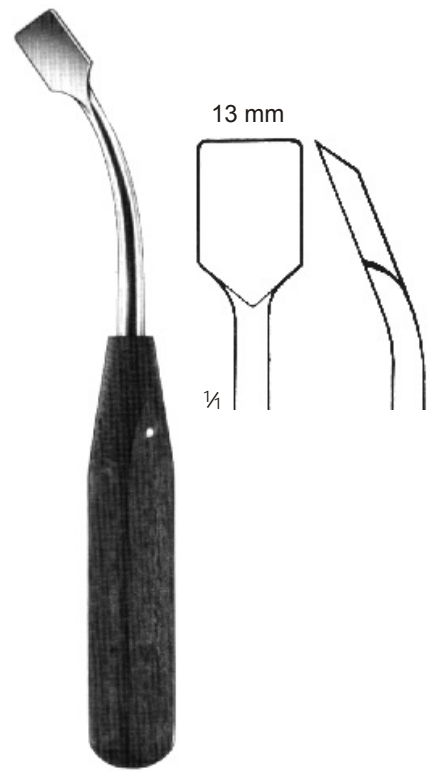

27-3628
 18,5 cm/7¼"



Adson
 17,0 cm/6¾"



27-3629-01



27-3629-02



27-3629-03



27-3629-04

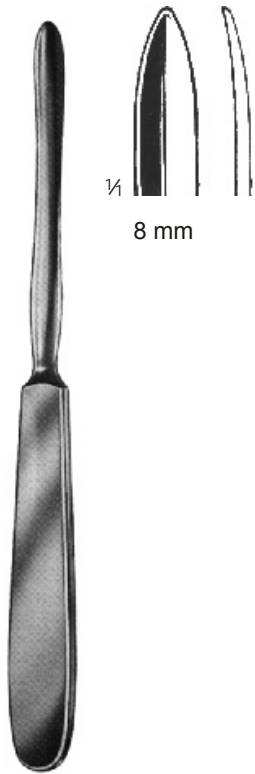

1/4
8 mm

Langenbeck

27-3630
20,0 cm/8"

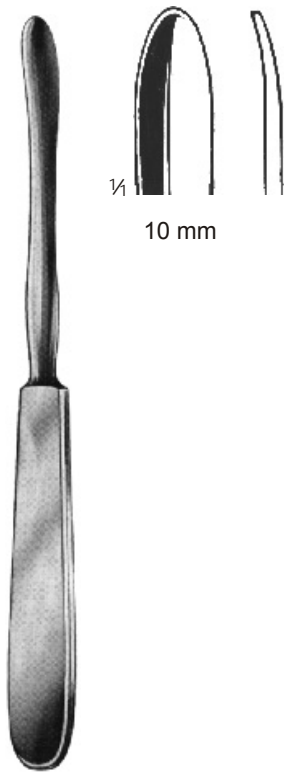

1/4
10 mm

Langenbeck

27-3631
20,0 cm/8"



5 mm

6,5 mm

Williger

27-3632
16,0 cm/6 1/4"

Williger

27-3633
17,0 cm/6 3/4"

6 mm



Quervain

27-3634-20
19,5 cm/7 3/4"



6 mm

6 mm

McDonald

27-3635
19,0 cm/7 1/2"



4 mm

Joseph





27-3636
16,5 cm/6 1/2"

Raspatorium
Periosteal Raspatory
Rugine-raspatoire
Legra-Periostótomo

27

Sehenschäler
Tendon stripper
Instrument à écorcher
Enucleador de tendones



-  27-3640-01
-  27-3640-02
-  27-3640-03
-  27-3640-04
- $\frac{1}{4}$  27-3640-05



Bunnell
15,0 cm/6"

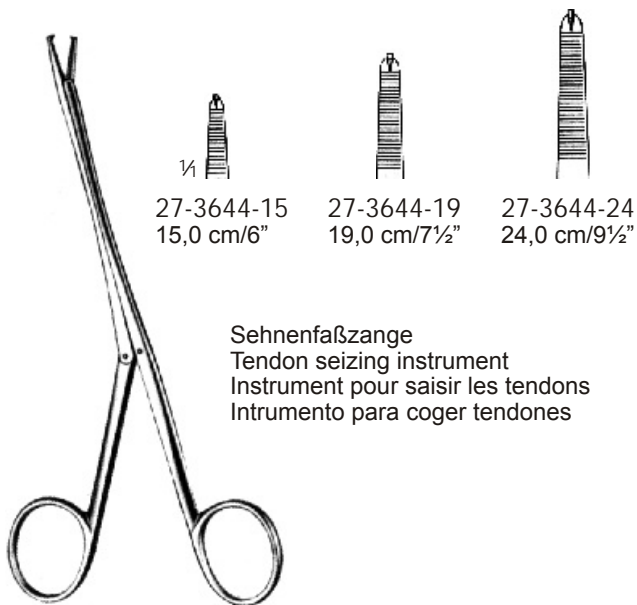

Sehnenführer
Tendon passing instrument
Instrument pour passer les tendons
Instrumento para el tunel del tendón

Bunnell
27-3642
23,0 cm/9"



- $\frac{1}{4}$  27-3644-15
15,0 cm/6"
-  27-3644-19
19,0 cm/7½"
-  27-3644-24
24,0 cm/9½"

Sehnenfaßzange
Tendon seizing instrument
Instrument pour saisir les tendons
Instrumento para coger tendones

Brand



Caroll

27-3645
11,0 cm/4½"



Gallaher
18,0 cm/7"



Fig. 1
27-3647-01



Fig. 2
27-3647-02



Fig. 3
27-3647-03



Joseph
16,0 cm/6½"



Fig. 1
27-3648-01



Fig. 2
27-3648-02



Fig. 3
27-3648-03



27-3650
24,5 cm/9¾"

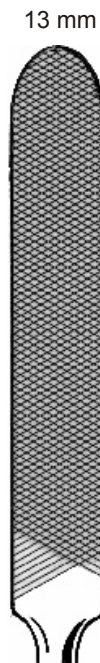

13 mm



27-3651
28,0 cm/11"

20 mm

27

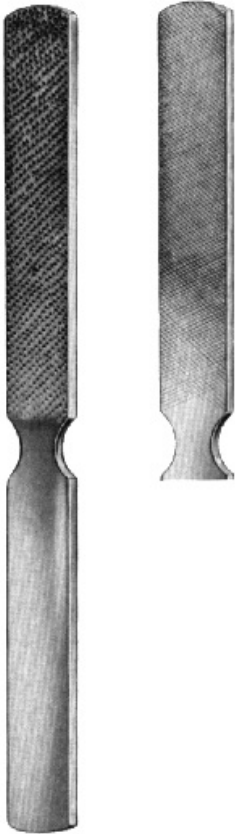

27-3652
22,0 cm/8¾"



Putti
27-3653
30,0 cm/12"



Putti
27-3654
27,0 cm/10½"



Smillie
17,0 cm/6¾"

Fig. 1
27-3655-01



Fig. 2
27-3655-02



Fig. 3
27-3655-03



Bircher

27-3656-01
19,0 cm/7½"



Bircher

27-3656-02
19,0 cm/7½"

27



doppelschneidig
double edged
double tranchant
doble cortante

27-3657-18
18,0 cm/7"



Neff
22,0 cm/8¾"

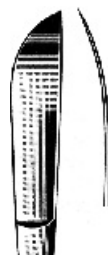

27-3658-01



27-3658-02



Salenius

27-3659-01
22,0 cm/8¾"



Salenius

27-3659-02
22,0 cm/8¾"

2,8 mm

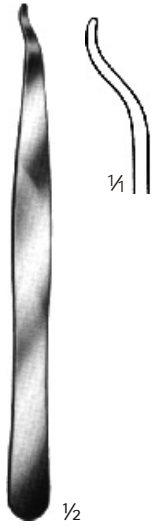

27-3660-03
14,0 cm/5½"

5 mm

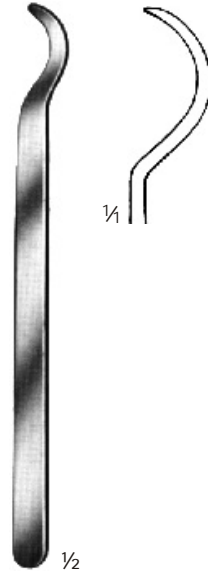

27-3661-05
15,0 cm/6"

7 mm

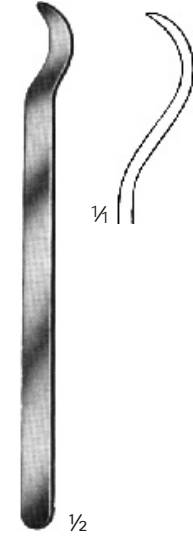

27-3662-07
15,0 cm/6"

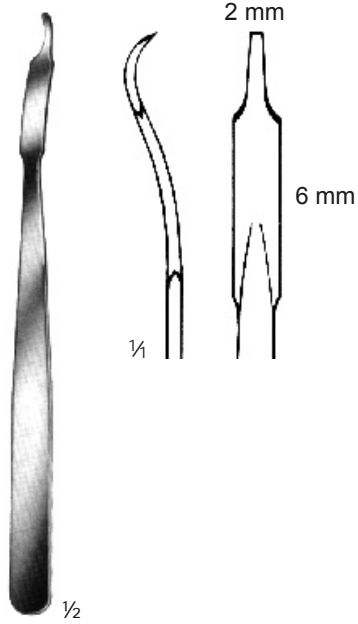

Mini-Hohmann

27-3664-06
16,0 cm/6¼"

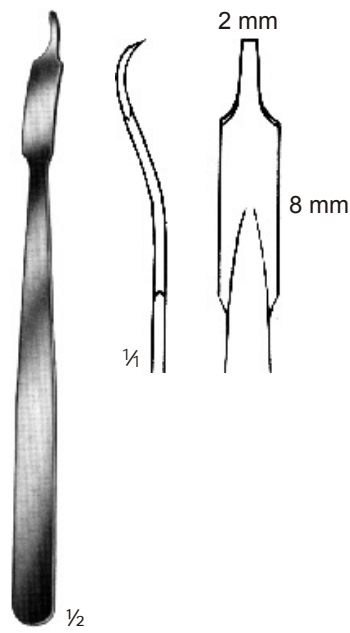

Mini-Hohmann

27-3664-08
16,0 cm/6¼"

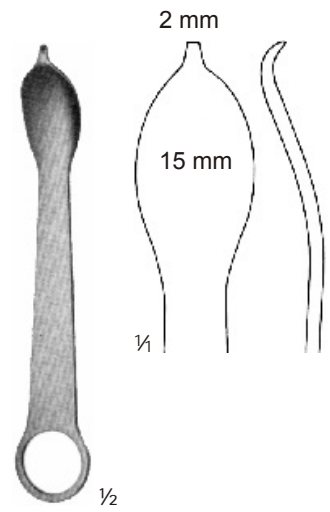

27-3665-15
12,5 cm/5"

27

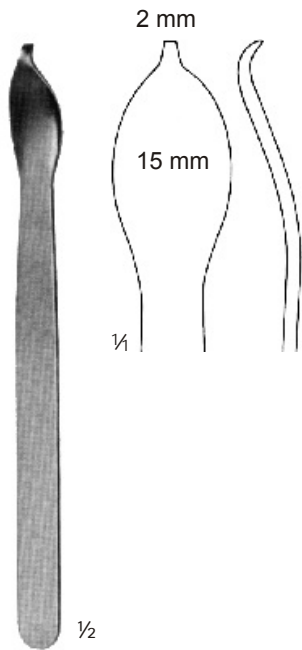

27-3666-15
 16,0 cm/6¼"



Hohmann
 22,0 cm/8¾"

27-3667-08 8 mm
 27-3667-10 10 mm

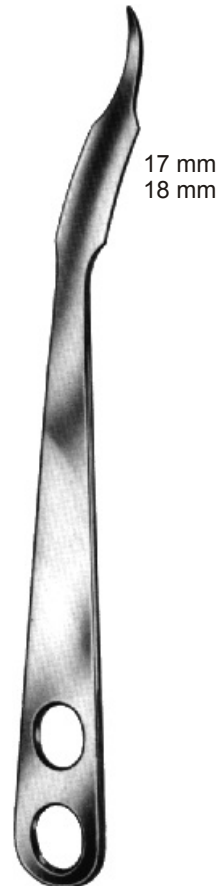

Hohmann
 24,0 cm/9½"

27-3667-17 17 mm
 spitz, sharp
 pointu, agudo

27-3667-18 18 mm
 stumpf, blunt
 mousse, romo

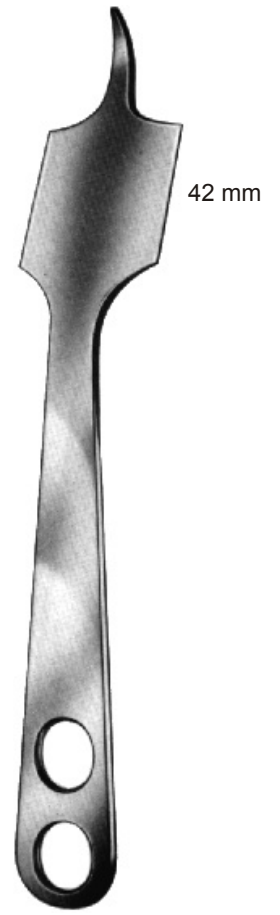

Hohmann

27-3667-42
 24,0 cm/9½"



65 mm

Hohmann

27-3667-65
25,5 cm/10"



43 mm

Hohmann

27-3668-43
24,0 cm/9½"



22 mm

Hohmann

27-3669-22
26,0 cm/10¼"



24 mm

Hohmann

27-3669-24
27,0 cm/10¾"

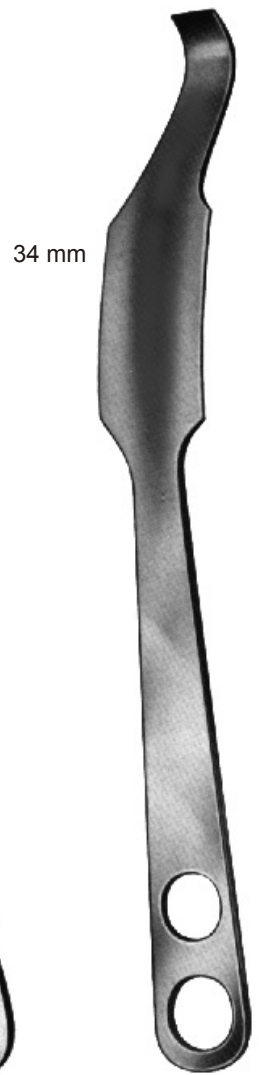

34 mm

Hohmann

27-3669-34
28,5 cm/11¼"

27

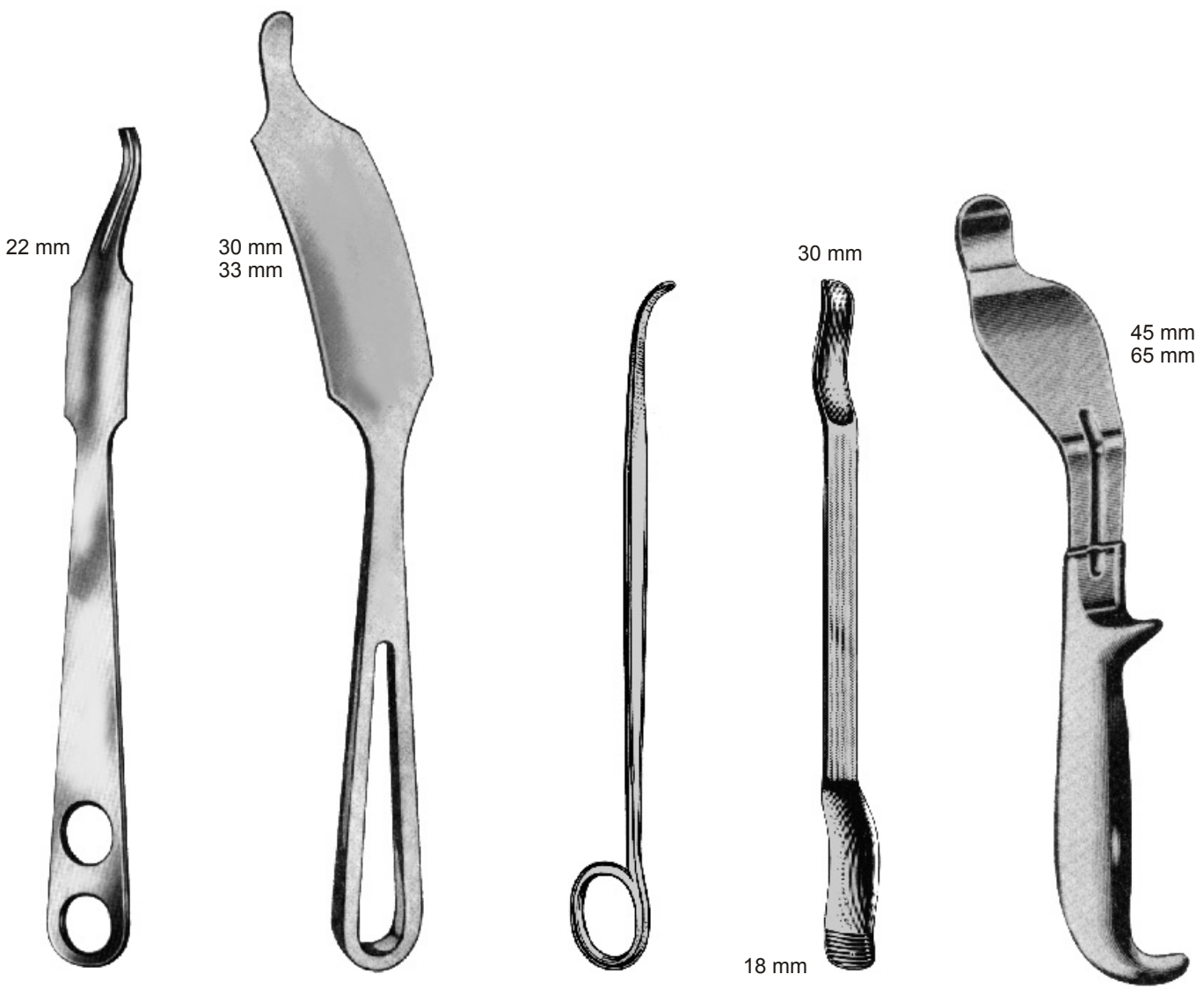

Lange-Hohmann

27-3670-22
25,0 cm/10"

Lange-Hohmann modif.

27-3671-30 30 mm
26,5 cm/10½"

27-3671-33 33 mm
28,0 cm/11½"

Lane

27-3673-21
21,5 cm/8½"

Murphy-Lane

27-3674-34
34,0 cm/13½"

Bennett

24,0 cm/9½"

27-3675-45 45 mm
27-3675-65 65 mm

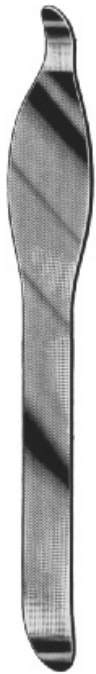

38 mm

Blount

27-3676-01
 26,0 cm/10¼"

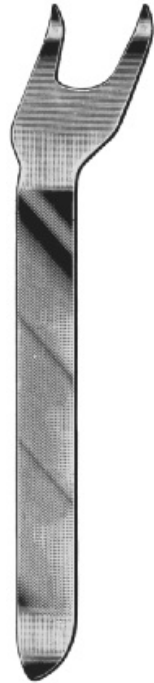

Blount

27-3676-02
 26,0 cm/10¼"



Meniskushaken
 Meniscus retractors
 Ecarteurs pour le ménisque
 Separadores para menisco

Blount

27-3677-18
 17,5 cm/7"



Spinalhaken
 Spinal retractors
 Ecarteurs spinaux
 Separadores espinales

Taylor
 16,5 cm/6½"

27-3678-07 75 x 30 mm
 27-3678-10 100 x 30 mm

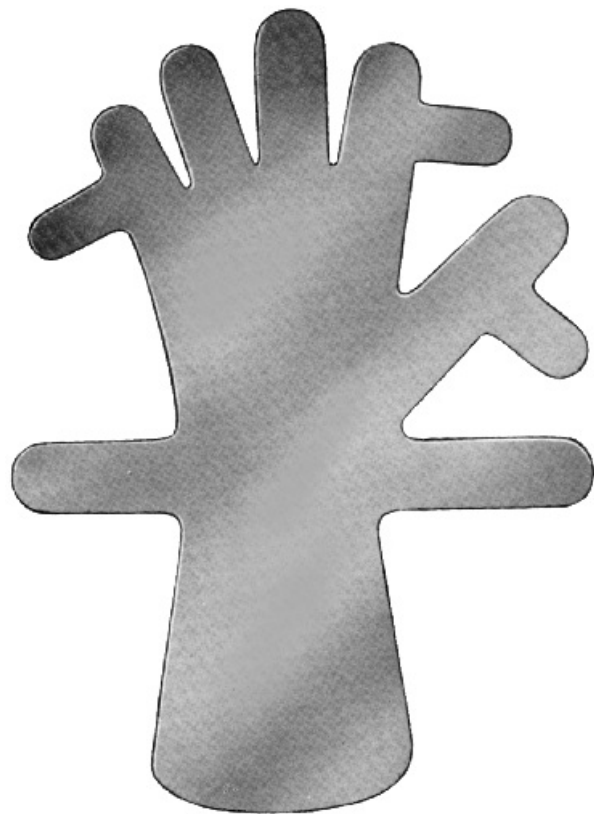

Bleihände
 Lead hands
 Main de plomb
 Mano de plomo

27-3679-01
 für Kinder
 for children
 pour enfants
 para niños

27-3679-02
 für Erwachsene
 for adults
 pour adultes
 para adultos



28 mmØ
340 g (12 oz.)

Williger

27-3680-28
24,0 cm/9½"

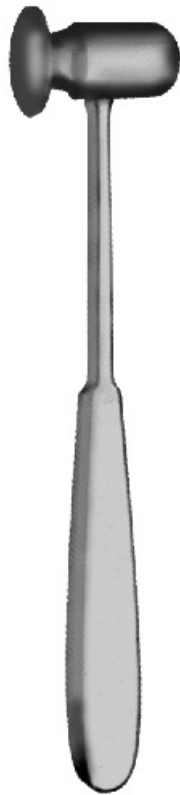

27-3681-25
25 mmØ
120 g (4¼ oz.)

27-3681-30
30 mmØ
180 g (6½ oz.)

27-3681-35
35 mmØ
260 g (9 oz.)

Doyen
21,0 cm/8¼"



30 mmØ
220 g (7¾ oz.)

Collin

27-3682-30
20,0 cm/8"

27



25 mmØ
260 g (9 oz.)

Lucae

27-3683-25
19,0 cm/7½"



20 mmØ
140 g (5 oz.)

bleigefüllt
lead filled
rempli de plomb
relleno de plomo

27-3684-01
16,5 cm/6½"



20 mmØ
140 g (5 oz.)

Messing massiv
solid brass
laiton solide
latón macizo

27-3684-02
16,5 cm/6½"



26 mmØ
320 g (11¼ oz.)

27-3685-02
Ferrozellbacken allein,
paarweise
Ferrozell jaws only,
pair
Plaques en matière Ferrozell,
pair
Tapas de Ferrozell sueltas,
par

Mead

27-3685-17
17,0 cm/6¾"



22 mmØ
200 g (7 oz.)

27-3686-01
bleigefüllt
lead filled
rempli de plomb
relleno de plomo

27-3686-02
Stahl, massiv
Steel, solid
Acier, solide
Acero, macizo

Partsch
18,0 cm/7"



25 mmØ
140 g (5 oz.)

27-3687-02
Ferrozellbacken allein,
paarweise
Ferrozell jaws only,
pair
Plaques en matière Ferrozell,
pair
Tapas de Ferrozell sueltas,
par

27-3687-25
18,5 cm/7¼"



30 mmØ
240 g (8¾ oz.)

Stahl, massiv
mit Leichtmetallgriff
Steel solid
with light metal handle
Acier solide
avec manche en métal léger
Acero, macizo,
con mango de metal ligero

Cottle

27-3688-30
18,5 cm/7¼"



27 mmØ
140 g (5 oz.)

Hajek

27-3689-27
21,5 cm/8½"



30 mmØ
300 g (10½ oz.)

Bergmann

27-3690-30
23,5 cm/9¼"

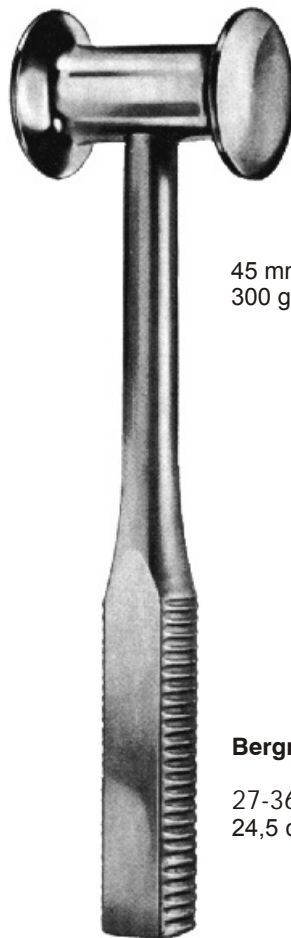

45 mmØ
300 g (10½ oz.)

Bergmann

27-3690-45
24,5 cm/9¾"



40 mmØ
550 g (19 oz.)

Ombredanne

27-3691-40
24,0 cm/9½"

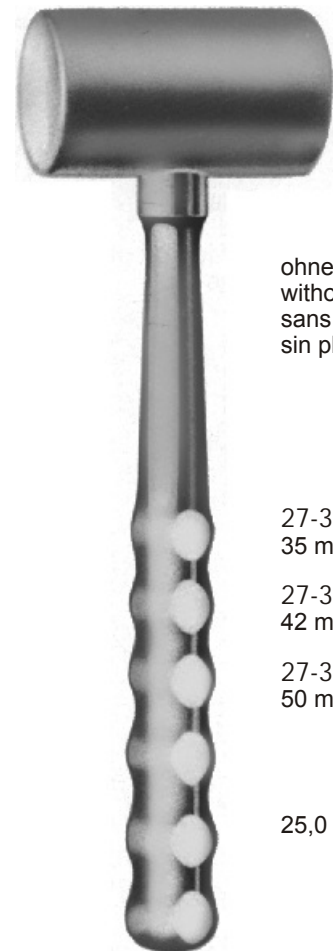

ohne Blei
without lead
sans plomb
sin plomo

27-3692-35
35 mmØ

27-3692-42
42 mmØ

27-3692-50
50 mmØ

25,0 cm/10"

27



42 mmØ

30 mmØ

400 g (14 oz.)

Stahl, massiv
mit Leichtmetallgriff
Steel solid
with light metal handle
Acier solide
avec manche en métal léger
Acero, macizo,
con mango de metal ligero

27-3693-42
24,0 cm/9½"



30 mmØ
510 g (18 oz.)

27-3695
26,0 cm/10¼"



450 g (1 lb.)

Stahl, massiv
Steel, solid
Acier, solide
Acero, macizo

27-3694-01
26,5 cm/10½"



900 g (2 lb.)

Stahl, massiv
Steel, solid
Acier, solide
Acero, macizo

27-3694-02
26,5 cm/10½"



30 mmØ
125 g (4 oz.)

Ferrozell, massiv
Ferrozell, solid
Ferrozell, solide
Ferrozell, macizo

27-3696-18
18,0 cm/7"

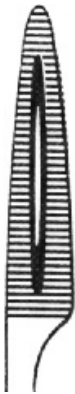

27-3700-01
gerade
straight
droite
recta



20,0 cm/8"



27-3700-02
aufgebogen
curved on flat
courbe vers le haut
curva sobre el plano



27-3701-14
14,0 cm/5½"

Sequesterzangen
Sequestum Forceps
Pince à séquestre
Pinza para secuestros

27

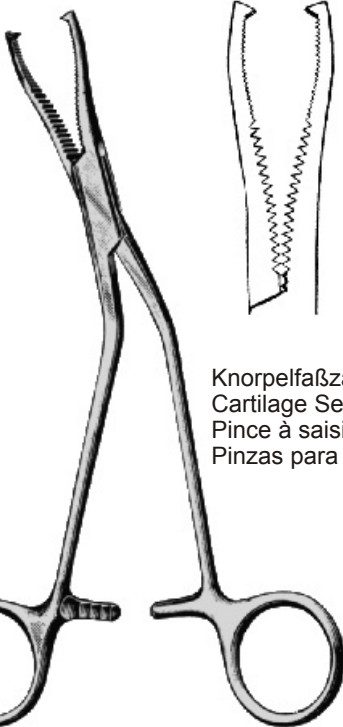

Knorpelfaßzange
Cartilage Seizing Forceps
Pince à saisir cartilages
Pinzas para coger cartílagos

Dingmann

27-3702
19,0 cm/7½"

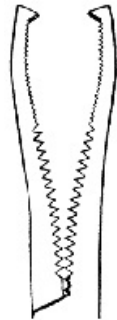

27-3703
12,0 cm/4¾"



Lewin

27-3704-17
17,5 cm/7"

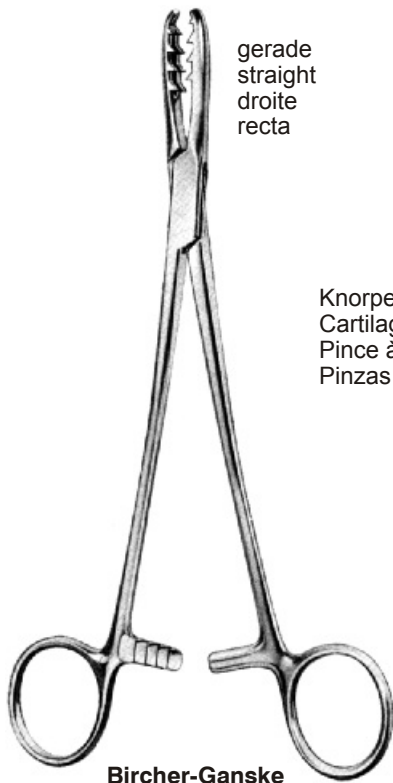

gerade
straight
droite
recta

Knorpelfaßzangen
Cartilage Seizing Forceps
Pince à saisir cartilages
Pinzas para coger cartílagos

Bircher-Ganske

27-3705-01
20,0 cm/8"



gebogen
curved
courbe
curva

Bircher-Ganske

27-3705-02
20,0 cm/8"



Setter

27-3706-16
16,0 cm/6¼"
27-3706-24
24,0 cm/9½"



Semb

27-3707
19,0 cm/7½"

ohne Sperre
without ratchet
sans crémaillère
sin cremallera



Semb

27-3708
19,0 cm/7½"

mit Sperre
with ratchet
avec crémaillère
con cremallera



Van Buren

27-3709
23,0 cm/9"



Langenbeck

27-3710
21,0 cm/8¼"



Farabeuf

27-3711
23,0 cm/9"
27-3712
26,0 cm/10¼"



Fergusson

27-3713
21,0 cm/8¼"

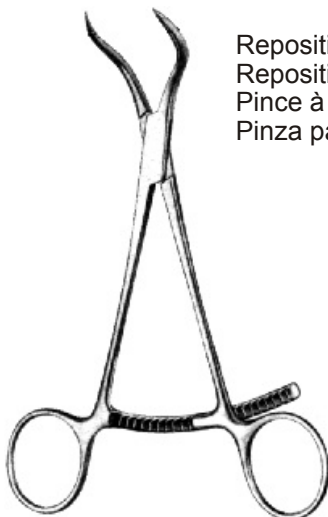

Repositionszange
Reposition Forceps
Pince à réduction
Pinza para reposición

27-3714
13,5 cm/5¼"



Farabeuf-Lambotte

27-3715
26,0 cm/10¼"
mit Sperre
with ratchet
avec crémaillère
con cremallera

27



27-3716-20
20,0 cm/8"

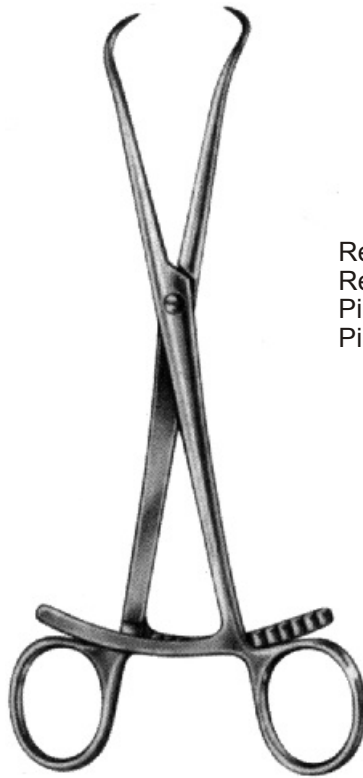

27-3717-01
20,0 cm/8"

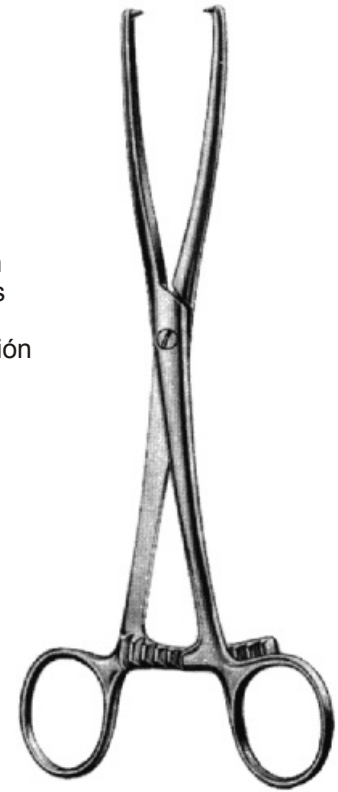

27-3717-02
21,0 cm/8¼"

Repositionszangen
Reposition Forceps
Pince à reduction
Pinza para reposición

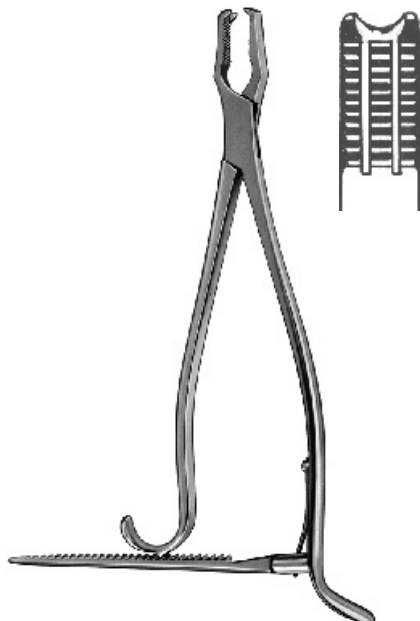

Baby-Kern

27-3718
15,0 cm/6"
mit Sperre
with ratchet
avec crémaillère
con cremallera

27-3719
15,0 cm/6"
ohne Sperre
without ratchet
sans crémaillère
sin cremallera



Kern

27-3718-17
17,0 cm/6³/₄"

27-3720
21,0 cm/8¹/₄"

mit Sperre
with ratchet
avec crémaillère
con cremallera

27-3719-17
17,0 cm/6³/₄"

27-3721
21,0 cm/8¹/₄"

ohne Sperre
without ratchet
sans crémaillère
sin cremallera



27

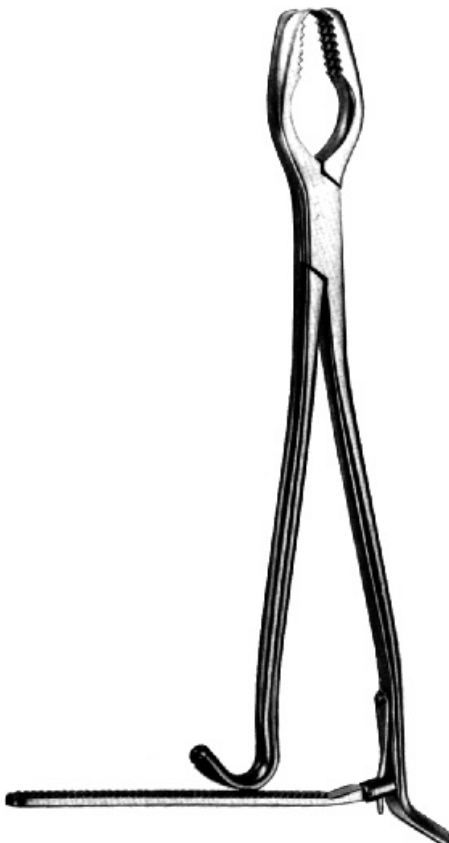

Lane

27-3722
33,0 cm/13"

27-3724
45,0 cm/17³/₄"

mit Sperre
with ratchet
avec crémaillère
con cremallera

27-3723
33,0 cm/13"

27-3725
45,0 cm/17³/₄"

ohne Sperre
without ratchet
sans crémaillère
sin cremallera





Lambotte

27-3727 22,0 cm/8³/₄"
27-3728 26,0 cm/10¹/₄"
27-3729 33,0 cm/13"

gerade
straight
droite
recta



Lambotte

27-3730 19,0 cm/7¹/₂"
27-3731 23,0 cm/9"
27-3732 26,0 cm/10¹/₄"

rechtswärts gebogen
right angled
courbe à droite
curva a la derecha



Lambotte

27-3733 22,0 cm/8³/₄"
27-3734 27,0 cm/10³/₄"
27-3735 30,0 cm/11³/₄"

verstellbar
adjustable
ajustable
ajustable

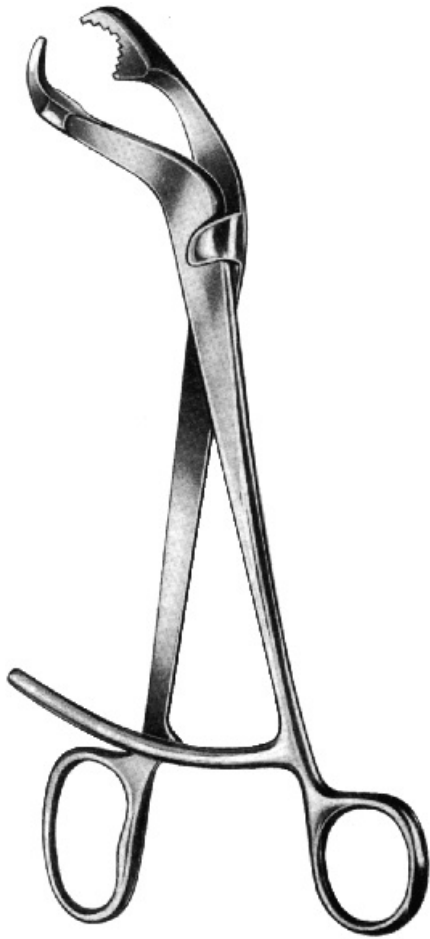

Verbrugge

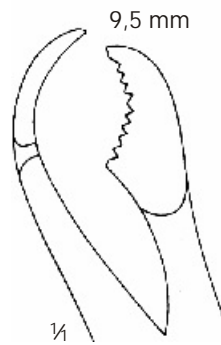

9,5 mm

¼

Fig. 1
27-3736
25,0 cm/10"

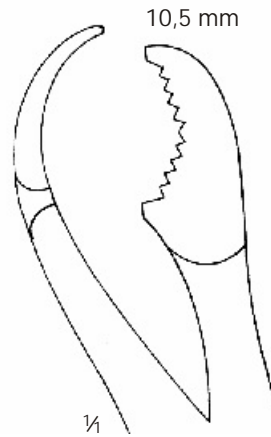

10,5 mm

¼

Fig. 2
27-3737
26,0 cm/10¼"

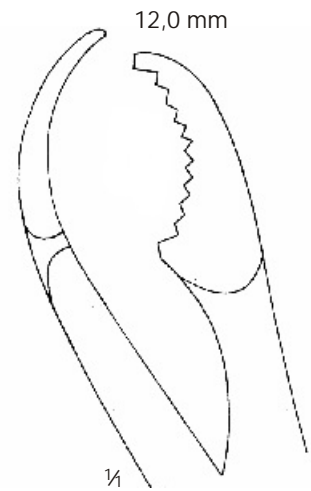

12,0 mm

¼

Fig. 3
27-3738
27,0 cm/10¾"



Verbrugge-Baby

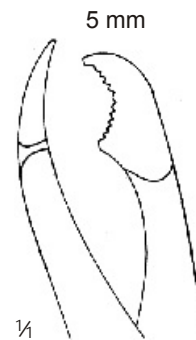

5 mm

¼

27-3739
17,5 cm/7"



Verbrugge

Fig. 00	27-3740	15,0 cm/6"	2,5 mm
Fig. 0	27-3741	19,0 cm/7½"	6,5 mm
Fig. 1	27-3742	24,0 cm/9½"	9,5 mm
Fig. 2	27-3743	26,0 cm/10¼"	10,0 mm
Fig. 3	27-3744	28,0 cm/11"	11,0 mm



Ulrich

27-3745	23,0 cm/9"
27-3746	25,0 cm/10"
27-3747	28,0 cm/11"

gerade
straight
droite
recta



Ulrich

27-3748	28,0 cm/11"
---------	-------------

seitwärts gebogen
curved sideways
courbe sur le côté
curva al lado



Luer
15,0 cm/6"



Fig. 1
27-3750-01



Fig. 2
27-3750-02



Fig. 3
27-3750-03



2,5 mm



27-3751-19
gerade
straight
droite
recta

2,5 mm



27-3752-19
gebogen
curved
courbe
curva

Lempert
19,0 cm/7½"

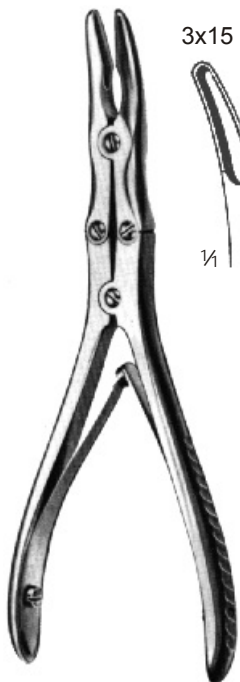

Beyer

27-3753
18,0 cm/7"



27-3754
gerade
straight
droite
recta



27-3755
gebogen
curved
courbe
curva



Ruskin
18,0 cm/7"



5 mm



27-3754-23
gerade
straight
droite
recta

5 mm







27-3755-23
gebogen
curved
courbe
curva

Röttgen-Ruskin



27-3754-23
23,0 cm/9"

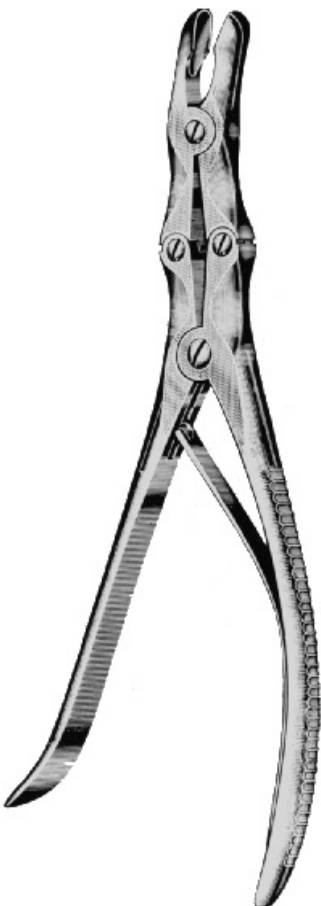

	10 mm	10 mm	17 mm	17 mm
				
¼				
	27-3756 22,0 cm/8¾"	27-3757 22,0 cm/8¾"	27-3756-27 27,0 cm/10¾"	27-3757-27 27,0 cm/10¾"
	gerade straight droite recta	gebogen curved courbe curva	gerade straight droite recta	gebogen curved courbe curva

Stille-Luer



	4 mm	8 mm
		
¼		
	27-3758-04	27-3758-08

Leksell-Stille

24,0 cm/9½"

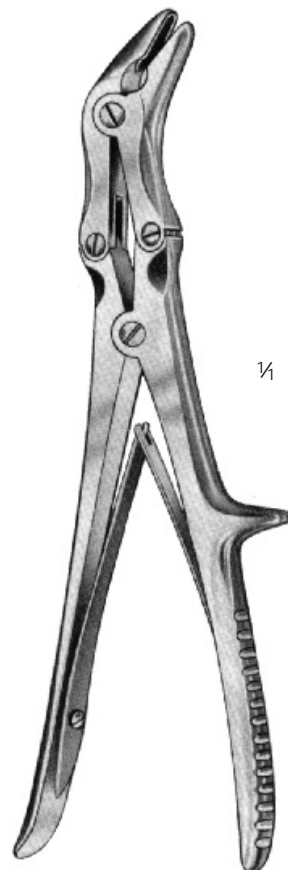

	7 mm
	
¼	

Stille

27-3758-23
23,0 cm/9"



Luer
17,0 cm/6¾"



27-3759

gerade
straight
droite
recta



27-3760

gebogen
curved
courbe
curva



Luer-Friedmann

27-3761
14,0 cm/5½"

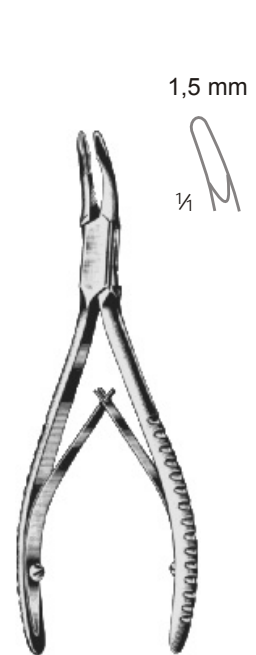

Micro-Friedmann

27-3761-02
14,0 cm/5½"



Mini-Friedmann

27-3761-03
12,0 cm/5"

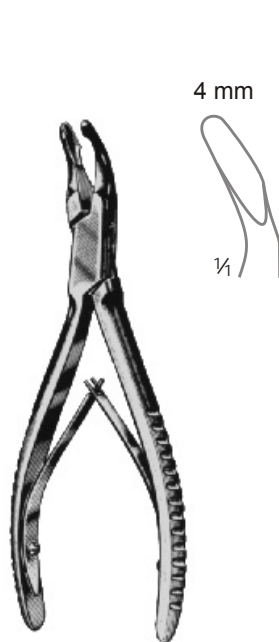

Cleveland

27-3762
14,0 cm/5½"

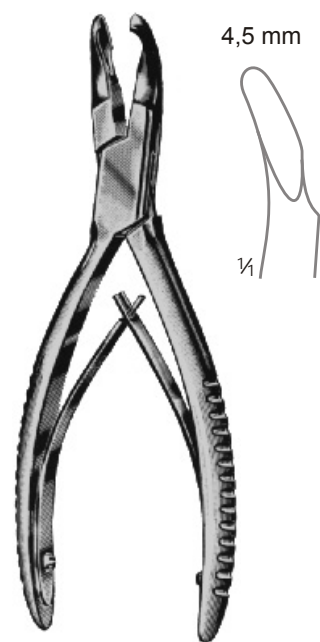

Cleveland

27-3763
17,0 cm/6¾"

27

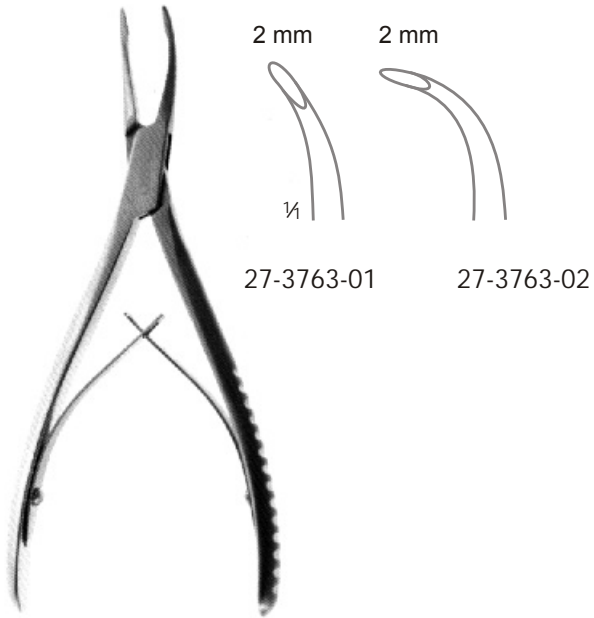

Stellbrink
 17,0 cm/6¾"

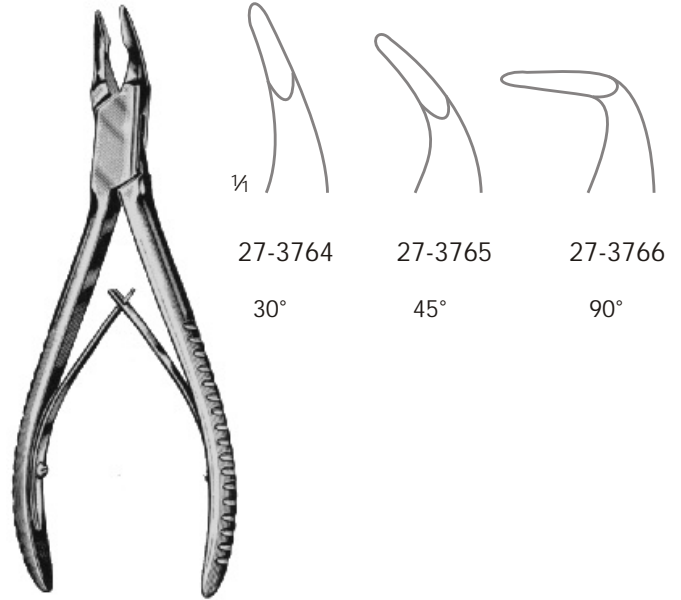

Blumenthal
 15,5 cm/6"

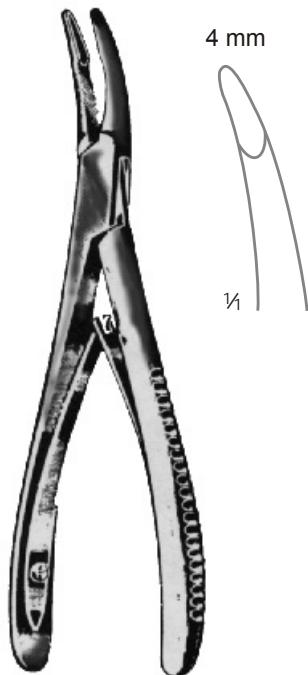

Zaufal
 27-3767
 17,0 cm/6¾"

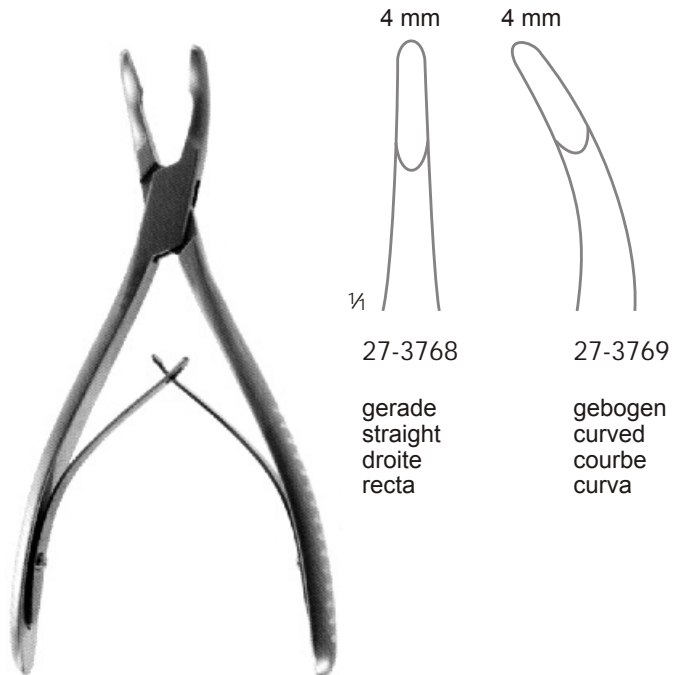

Jansen
 17,0 cm/6¾"

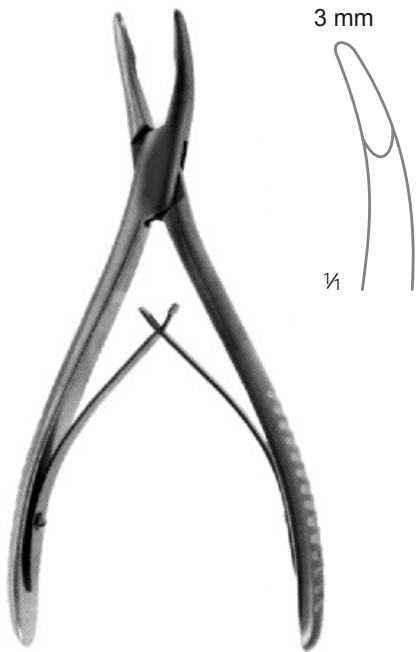

Bayer

27-3770
18,0 cm/7"

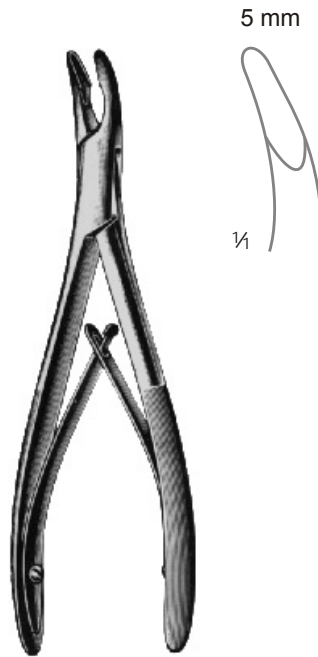

Bane (Hartmann)

27-3771
17,0 cm/6 3/4"

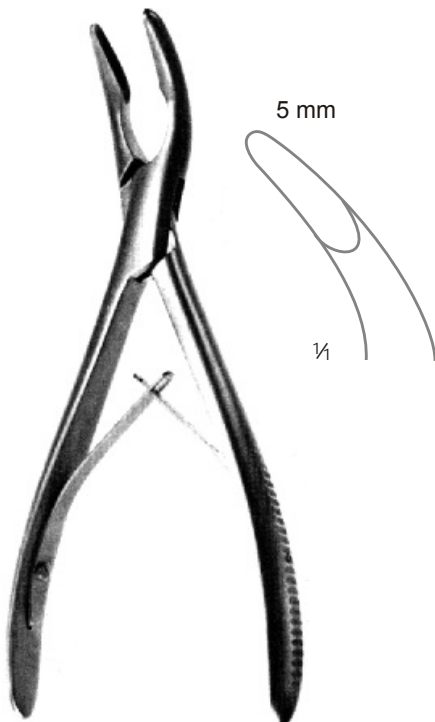

Olivecrona

27-3772
19,0 cm/7 1/2"

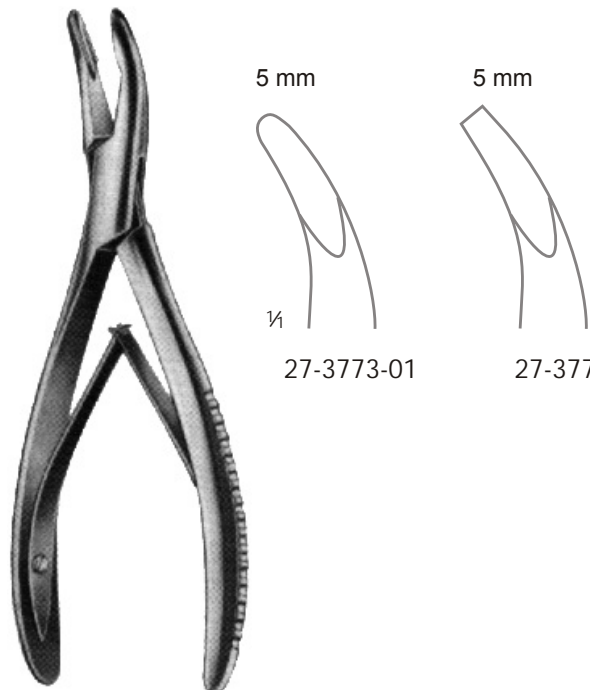

Mead

16,5 cm/6 1/2"

27-3773-01

27-3773-02

27



Adson

27-3774
20,0 cm/8"

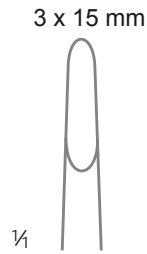

27-3775
gerade
straight
droite
recta



27-3776
gebogen
curved
courbe
curva

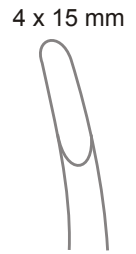

27-3777
gebogen
curved
courbe
curva

Böhler
15,0 cm/6"

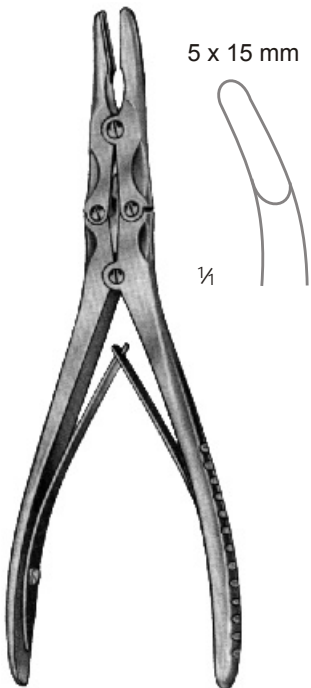

Zaufal-Jansen

27-3778
18,0 cm/7"

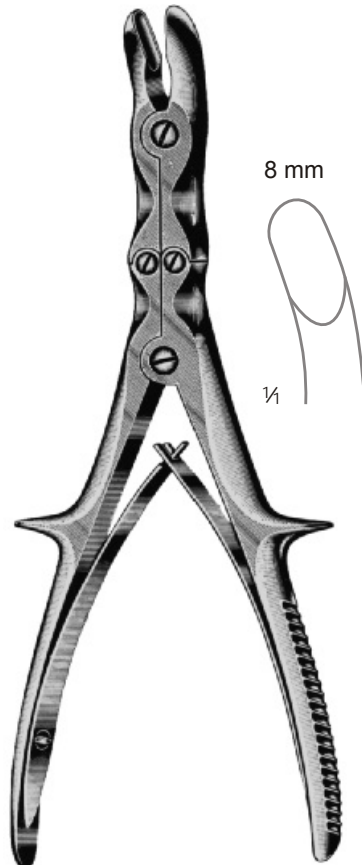

Stille-Ruskin

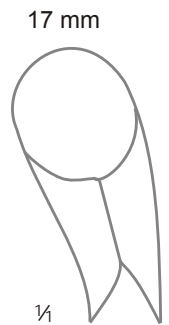
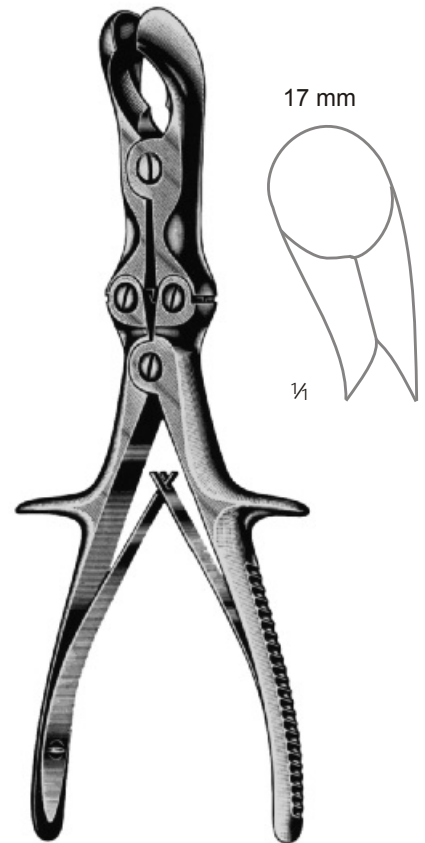

27-3779
23,0 cm/9"

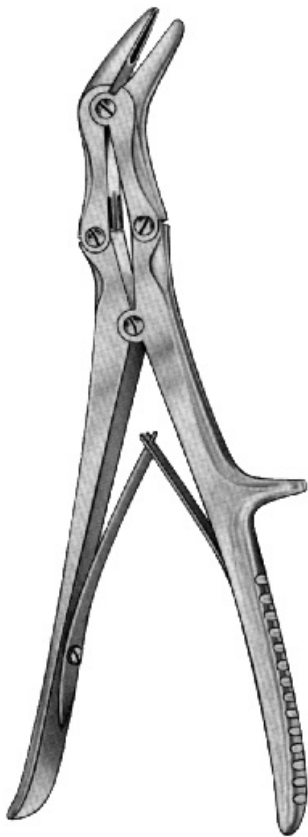

Semb

27-3780
22,5 cm/8 3/4"





2 x 10 mm	3 x 10 mm	4 x 10 mm
		
27-3781	27-3782	27-3783

seitwärts gebogen
curved sideways
courbe sur le côté
curva al lado

Echlin
23,0 cm/9"

27



3 mm	3 mm	3 mm
		
27-3784 19,0 cm/7½"	27-3785 19,0 cm/7½"	27-3786 19,0 cm/7½"
27-3787 24,0 cm/9½"	27-3788 24,0 cm/9½"	27-3789 24,0 cm/9½"
gerade straight droite recta	leicht gebogen slightly curved courbe légèrement curva ligeramente	stark gebogen fully curved courbe fortement curva fuertemente

Smith-Petersen



Sauerbruch
 30,0 cm/11¾"

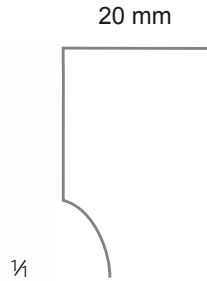

27-3790



27-3791

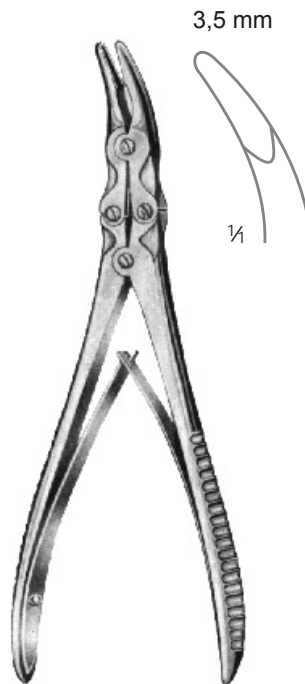

Mayfield

27-3792
 17,0 cm/6¾"

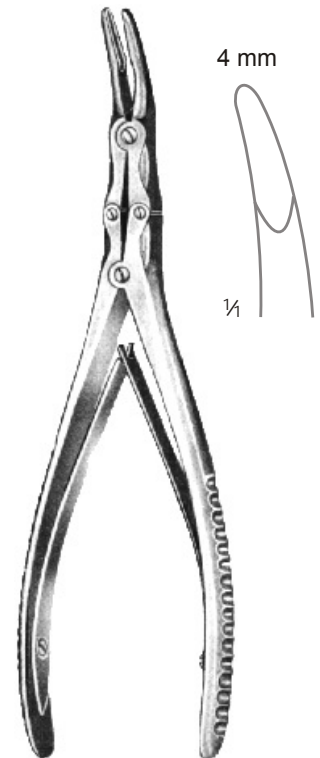

Marquardt

27-3793
 20,0 cm/8"



gerade
straight
droite
recta

27-3814 14,0 cm/5½"
27-3817 17,0 cm/6¾"
27-3819 19,0 cm/7½"
27-3822 22,0 cm/8¾"

Liston



gebogen
curved
courbe
curva

27-3824
27-3827
27-3829
27-3832



¼



27-3838
gerade
straight
droite
recta



27-3839
gebogen
curved
courbe
curva

Liston-Mini
15,0 cm/6"

27



gerade
straight
droite
recta

Stille-Liston

27-3840
27,0 cm/10½"



27-3841
27,0 cm/10½"
gebogen
curved
courbe
curva



Liston-Key

27-3842
27,0 cm/10½"



Stille-Liston

27-3843
27,0 cm/10½"



27-3844
15,0 cm/6"



27-3845
17,0 cm/6¾"

Cleveland
gebogen
curved
courbe
curva



27-3846
gerade
straight
droite
recta

Böhler
15,0 cm/6"



27-3847
nach vorn gebogen
curved forward
courbe en avant
curva hacia delante



27-3848
nach hinten gebogen
curved backward
courbe en arrière
curva hacia atrás



27-3849
gebogen
curved
courbe
curva

Mc Indoe
17,0 cm/6¾"



Ruskin
18,0 cm/7"



27-3850
gerade
straight
droite
recta



27-3851
gebogen
curved
courbe
curva



Ruskin-Liston
18,0 cm/7"



27-3852
gerade
straight
droite
recta



27-3853
gebogen
curved
courbe
curva



Semb

27-3854
23,0 cm/9"

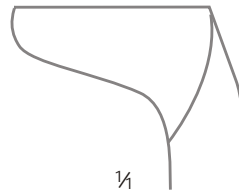

seitwärts gebogen
sideways curved
courbe sur le côté
curva al lado

1 x 1



Lowman

27-3855-12 12,0 cm/4³/₄"
27-3855-18 18,0 cm/7"
27-3855-20 20,0 cm/8"

1 x 2



Lowman

27-3856-12 12,0 cm/4³/₄"
27-3856-18 18,0 cm/7"
27-3856-20 20,0 cm/8"
27-3856-22 22,0 cm/8³/₄"

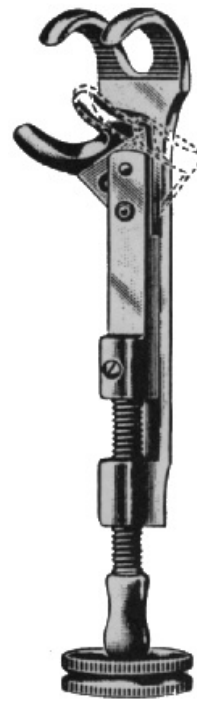

Lowman-Baby

27-3857-13
13,0 cm/4³/₄"

Lowman-Hoglund

27-3857-18
18,0 cm/7"



Gerster

27-3858
15,0 cm/6"

Distraktionsklammer
Traction bar
Clamp porte-os
Barra de tracción

**Herz-, Thorax- und Gefäß-Chirurgie
Cardiovascular and Thoracic Surgery
Chirurgie cardiovasculaire et Thoracoplastie
Cirugía cardiovascular y Toracoplástica**



28

mit ziehendem Schnitt
with eccentric sliding blade
avec lame glissante
con hoja de retroacción



28-3859
22,0 cm/8 $\frac{3}{4}$ "

Rippenschere
Rib Shears
Costotomes
Cizallas para costillas



28-3860-19 19,5 cm/7 $\frac{3}{4}$ "
28-3860-23 22,5 cm/9"

Knochenschere
Bone Shears
Cisailles pour os
Cizallas para huesos



Gluck

28-3861
21,0 cm/8 $\frac{3}{4}$ "

Rippenschere
Rib Shears
Costotomes
Cizallas para costillas

Griffe mit Gummiüberzug
 Handles with rubber cover
 Manches avec couverture en caoutchouc
 Mangos con cubierta de goma



Bethune

28-3863
 34,0 cm/13½"



Giertz-Stille

28-3864
 27,0 cm/10½"



Brunner

32,0 cm/12½"

28-3865
 für die rechte Hand
 for the right hand
 pour la main droite
 para la mano derecha

28-3866
 für die linke Hand
 for the left hand
 pour la main gauche
 para la mano izquierda

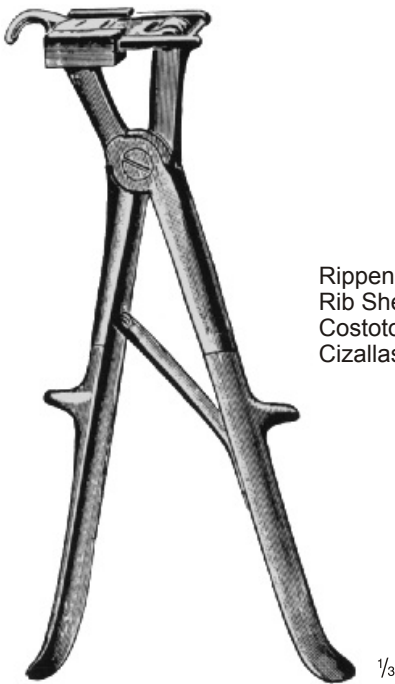

Rippenschere
Rib Shears
Costotomes
Cizallas para costillas

Sauerbruch

28-3867
26,0 cm/10¼"



Rippenschere
Rib Shears
Costotomes
Cizallas para costillas

Sauerbruch-Frey

28-3868
36,0 cm/14"



Sternumschere
Sternum scissors
Cisailles à sternum
Tijeras de esternón

Lebsche

28-3869
25,0 cm/10"



Sternummeißel
Sternum chisel
Burin à sternum
Cinzel de esternón

Lebsche

28-3871
24,5 cm/9¾"





Aluminium
Aluminium
Aluminium
Aluminio

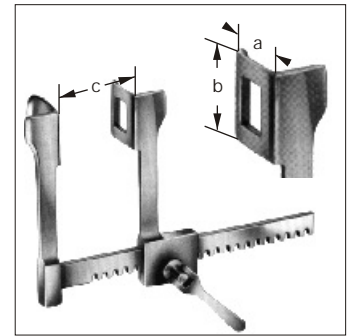

Finocchietto-Infant

	a	b	c
28-3880	10 mm	15 mm	70 mm



Aluminium
Aluminium
Aluminium
Aluminio

Finocchietto-Baby-Haight

	a	b	c
28-3881	31 mm	31 mm	80 mm



Aluminium
Aluminium
Aluminium
Aluminio

Finocchietto

	a	b	c
28-3882-01	30 mm	45 mm	140 mm
28-3882-02	40 mm	62 mm	175 mm
28-3882-03	64 mm	65 mm	175 mm





Aluminium
Aluminium
Aluminium
Aluminio

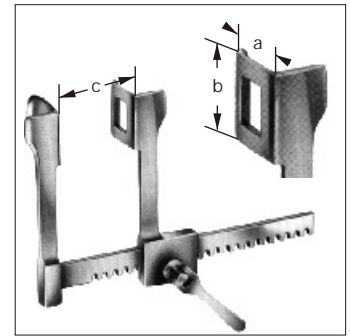

Burford	für Kinder for children pour enfants para niños		mit 2 Paar Valven with 2 pairs of blades avec 2 paires de valves con 2 pares de valvas
	a	b	c
28-3884	41 mm 30 mm	42 mm 42 mm	130 mm



Aluminium
Aluminium
Aluminium
Aluminio

Burford	für Erwachsene for adults pour adultes para adultos		mit 2 Paar Valven with 2 pairs of blades avec 2 paires de valves con 2 pares de valvas
	a	b	c
28-3885-01	65 mm 47 mm	62 mm 62 mm	165 mm
28-3885-02	65 mm 47 mm	62 mm 62 mm	250 mm
28-3885-03	65 mm 47 mm	62 mm 62 mm	290 mm



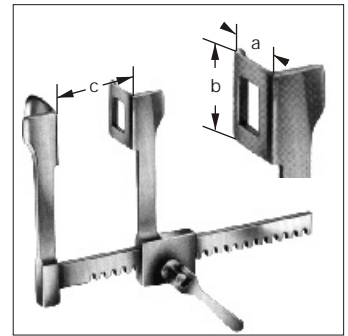

Aluminium
Aluminium
Aluminium
Aluminio

für Säuglinge
for newborns
pour bébés
para recién nacidos

Cooley

	a	b	c
28-3887-01	12 mm	16 mm	70 mm



Aluminium
Aluminium
Aluminium
Aluminio

für Kinder
for children
pour enfants
para niños

Cooley

	a	b	c
28-3887-02	15 mm	30 mm	100 mm

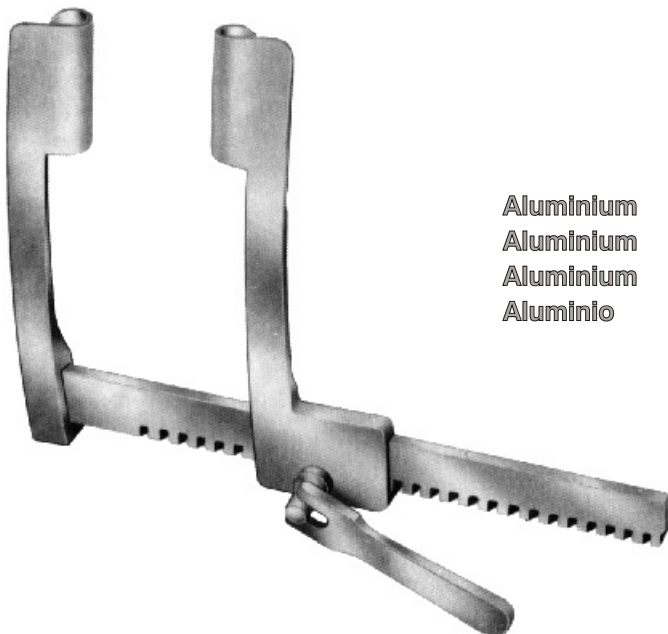

Aluminium
Aluminium
Aluminium
Aluminio

für Erwachsene
for adults
pour adultes
para adultos

Cooley

	a	b	c
28-3887-03	21 mm	44 mm	140 mm
28-3887-04	30 mm	50 mm	185 mm



Aluminium
Aluminium
Aluminium
Aluminio

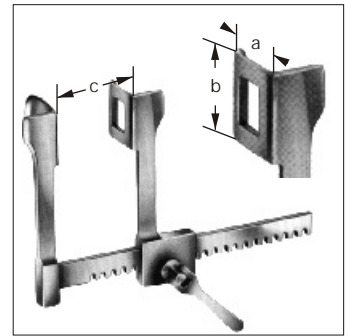

für Säuglinge
for newborns
pour bébés
para recién nacidos

Castañeda	a	b	c
28-3890-01	10,5 mm	32 mm	65 mm

für Kinder
for children
pour enfants
para niños

Castañeda	a	b	c
28-3890-02	12 mm	45 mm	70 mm
28-3890-03	15 mm	60 mm	100 mm

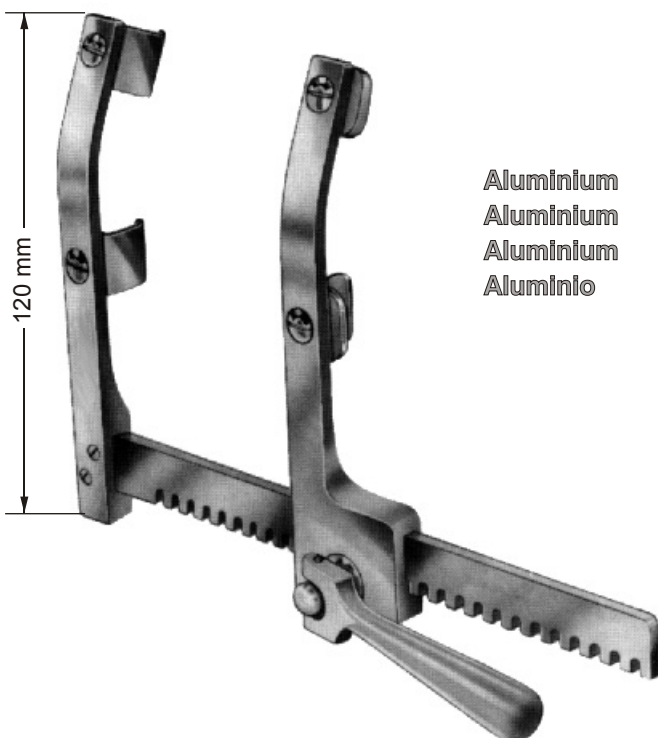

Aluminium
Aluminium
Aluminium
Aluminio

Morse	a	b	c
28-3892	20 mm	20 mm	165 mm



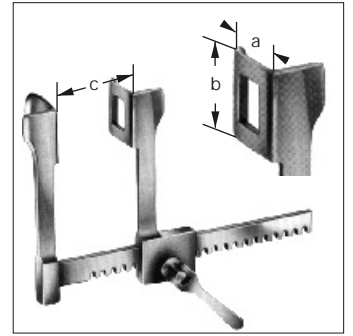
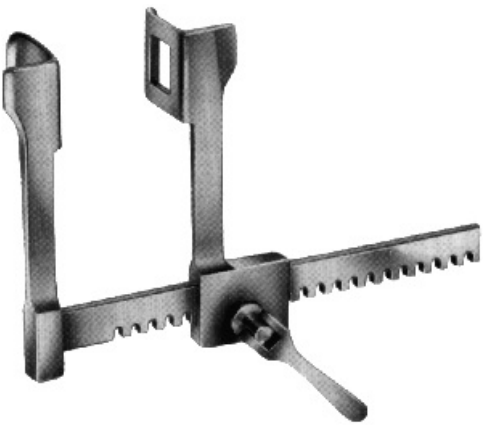

Finocchietto-Baby

	a	b	c
28-3900	19 mm	20 mm	75 mm

28



Finocchietto

	a	b	c
28-3901	40 mm	45 mm	165 mm
28-3902	45 mm	65 mm	200 mm
28-3903	65 mm	65 mm	250 mm

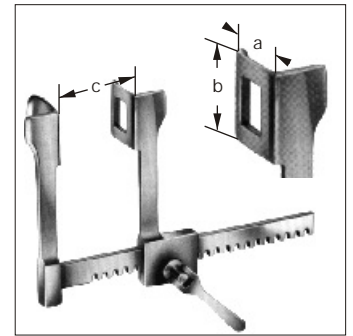
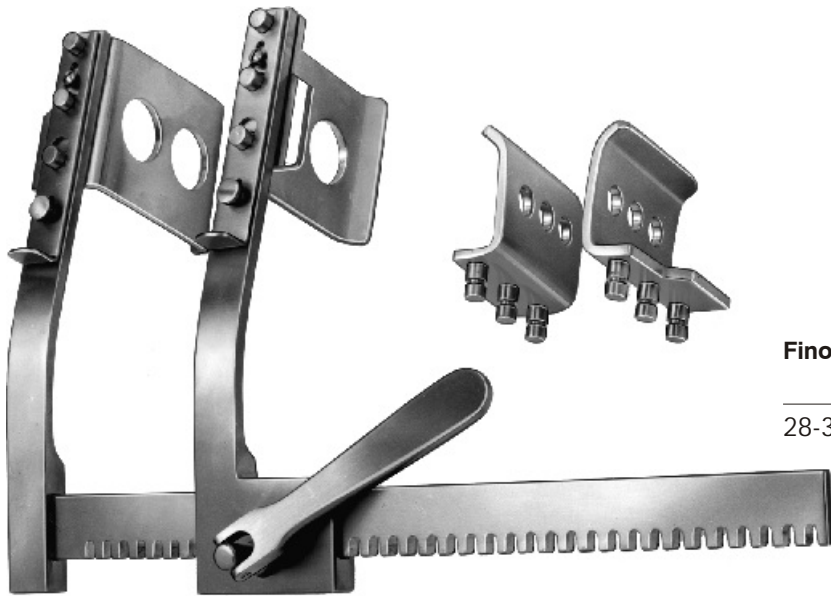

mit 2 Paar Valven
with 2 pairs of blades
avec 2 paires de valves
con 2 pares de valvas

Finocchietto-Burford

	a	b	c
28-3904	80 mm 40 mm	67 mm 67 mm	250 mm



Tuffier

	a	b	c
28-3905	50 mm	45 mm	165 mm

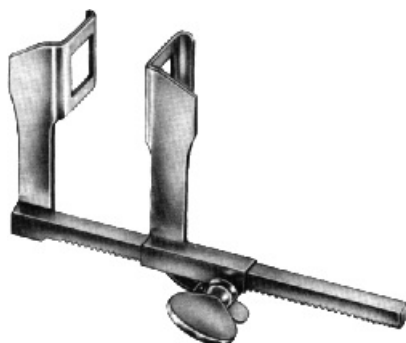

Haight

	a	b	c
28-3906	30 mm	30 mm	90 mm



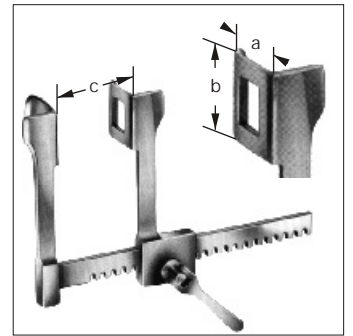

Cooley für Kinder
for children
pour enfants
para niños

	a	b	c
28-3907-01	21 mm	45 mm	145 mm



Cooley für Erwachsene
for adults
pour adultes
para adultos

	a	b	c
28-3907-02	32 mm	50 mm	190 mm

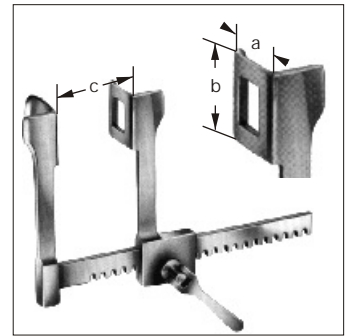
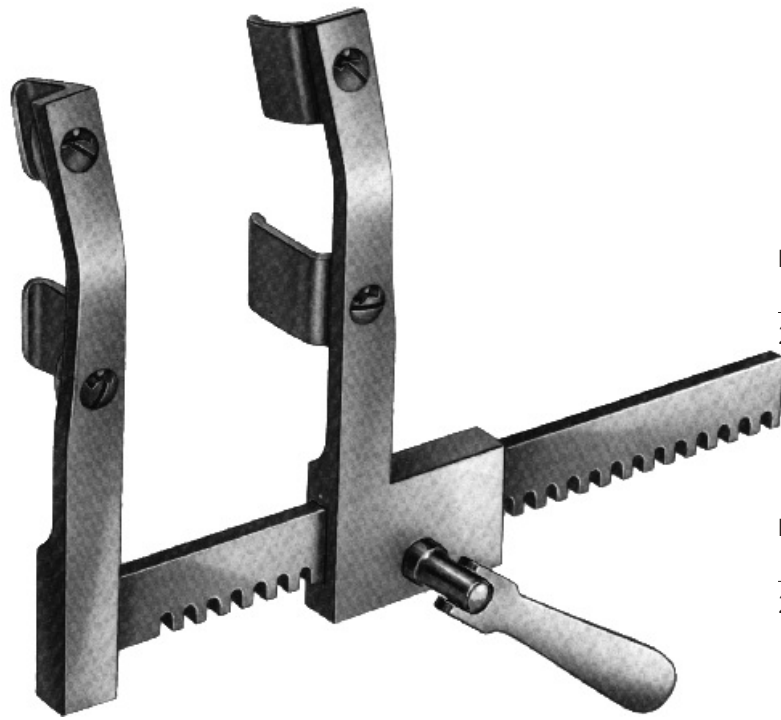

für Kinder
for children
pour enfants
para niños

Morse	a	b	c
28-3908-01	12 mm	20 mm	200 mm

für Erwachsene
for adults
pour adultes
para adultos

Morse	a	b	c
28-3908-02	19 mm	19 mm	200 mm



Morse-Favaloro	a	b	c
28-3908-03	38 mm	28 mm	200 mm



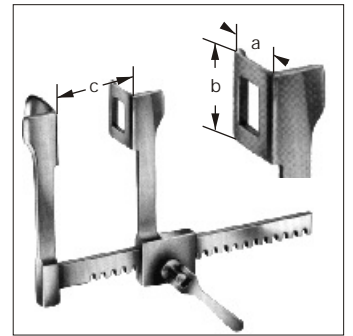

mit 1 Paar zusätzlich abnehmbaren Valven
 with 1 pair of additional detachable blades
 avec 1 paire de valves démontables, supplémentaire
 con 1 par de valvas desmontables, adicional

a	b
40 mm	50 mm

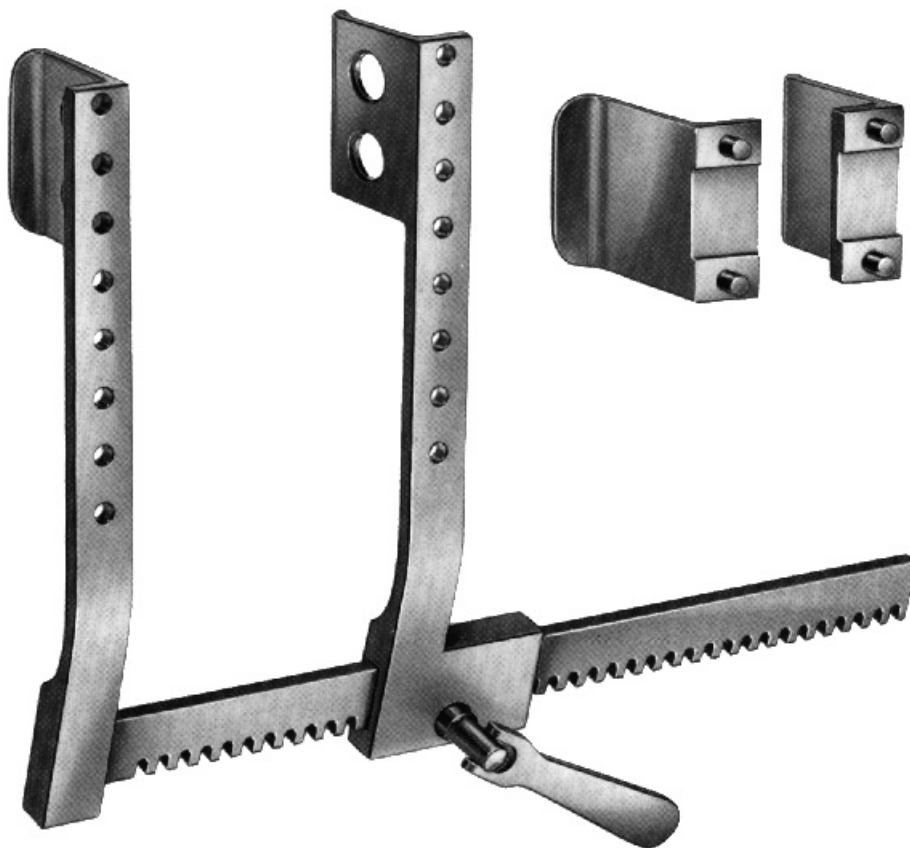

Harken

	a	b	c
28-3909	45 mm	65 mm	250 mm

28



Bailey-Gibbon

28-3910
16,0 cm/6¼"



Bailey

28-3911
16,0 cm/6¼"



Bailey-Baby

28-3912
14,0 cm/5½"



Lungenspatel
Lung Spatulas
Spatules pulmonaires
Espátulas pulmonares

Allison

28-3920-27 40 mm
27,0 cm/11"

28-3920-32 65 mm
32,0 cm/12½"





25 mm/1"

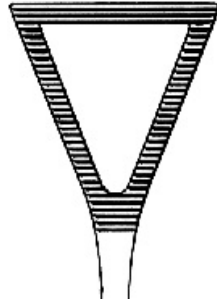

gerade
straight
droite
recta

Duval

28-4052 28.4054
20,0 cm/8" 23,0 cm/9¼"



25 mm/1"

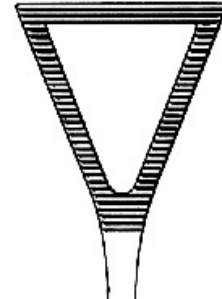

gebogen
curved
courbe
curva

Lovelace

28-4053
20,0 cm/8"



13 mm/½"



28-4057
20,0 cm/8"

25 mm/1"

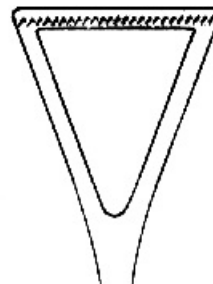

28-4058
20,0 cm/8"

28-4059
23,0 cm/9¼"

Collin



S



Bronchusklemmen
Bronchus Clamps
Pinces-clamps à bronches
Pinzas-clamps para bronquios

Price-Thomas

28-4060
22,5 cm/9"



28-4061-01

28-4061-02

Bronchusklemmen
Bronchus Clamps
Pinces-clamps à bronches
Pinzas-clamps para bronquios

Price-Thomas

22,5 cm/9"

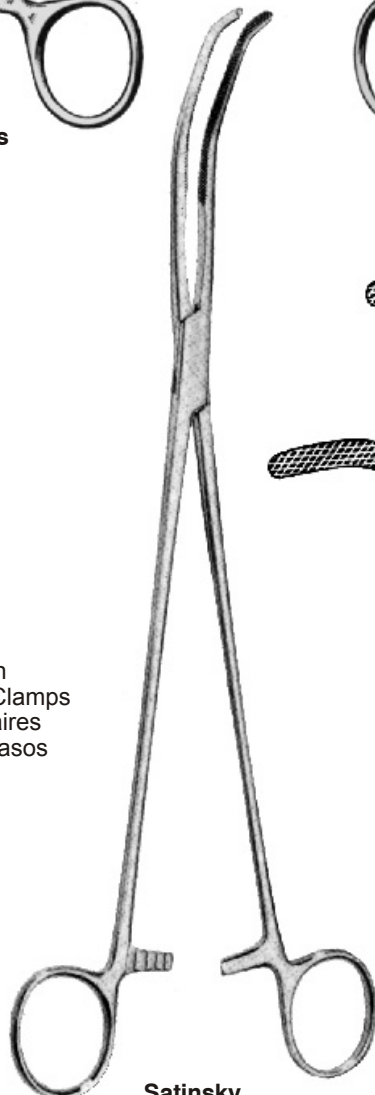

Gefäßklemmen
Blood Vessel Clamps
Pinces vasculaires
Clamps para vasos

Satinsky
26,5 cm/10½"

Fig. 1
28-4064

Fig. 2
28-4065

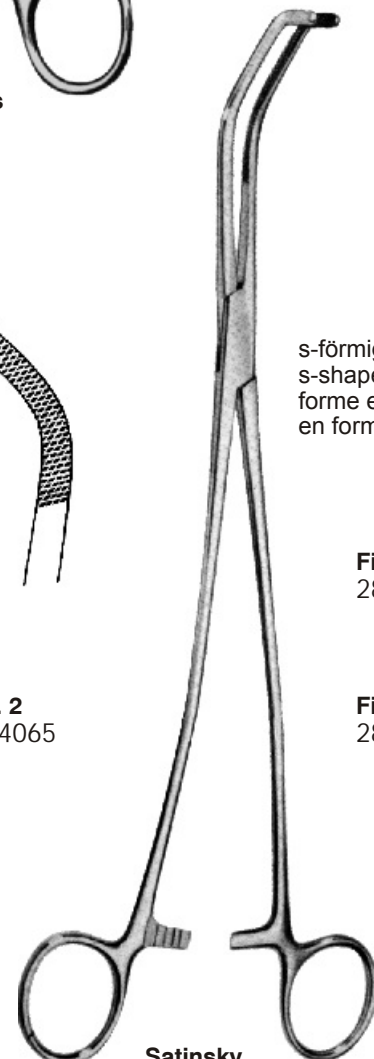

s-förmig
s-shaped
forme en S
en forma de S

Fig. 1
28-4066

Fig. 2
28-4067

Satinsky
26,5 cm/10½"



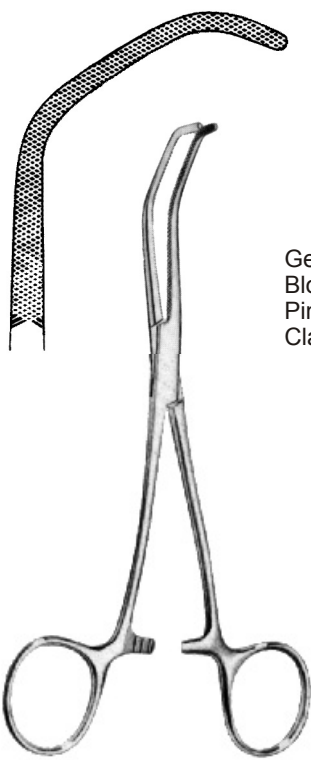

Baby-Satinsky

28-4068
15,0 cm/6"

Gefäßklemmen
Blood Vessel Clamps
Pinces vasculaires
Clamps para vasos

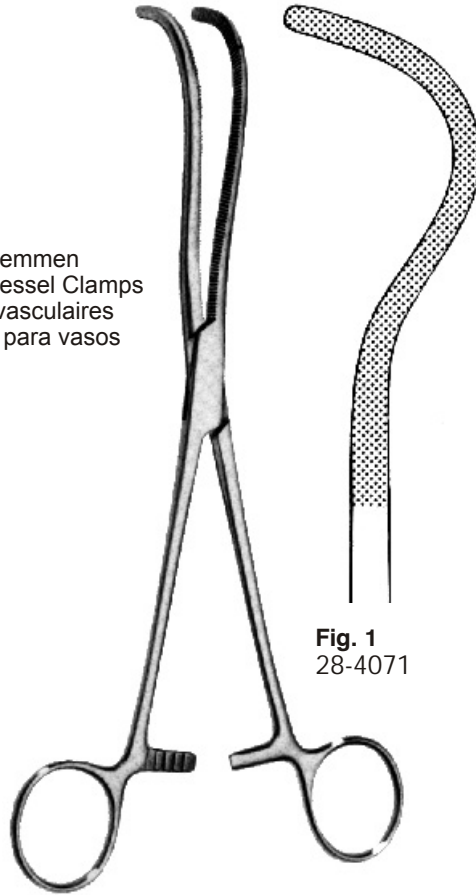

Fig. 1
28-4071

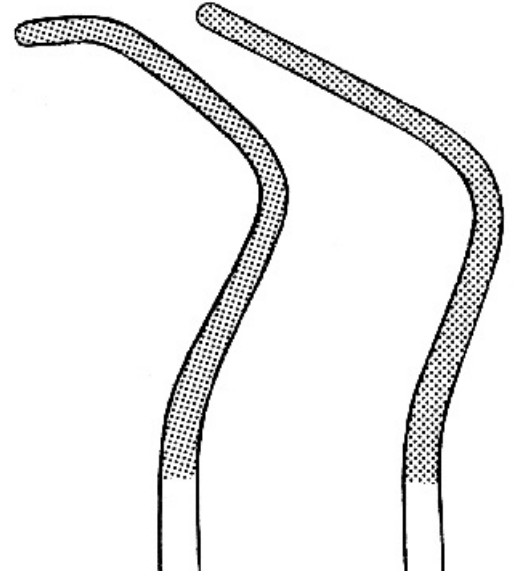

Fig. 2
28-4072

Fig. 3
28-4073

Harken
24,0 cm/9½"

88
2



19,0 cm/7½"

Gefäßdilatoren
Vascular Dilators
Dilatateurs vasculaires
Dilatadores vasculares

biegsam
malleable
malléable
flexible

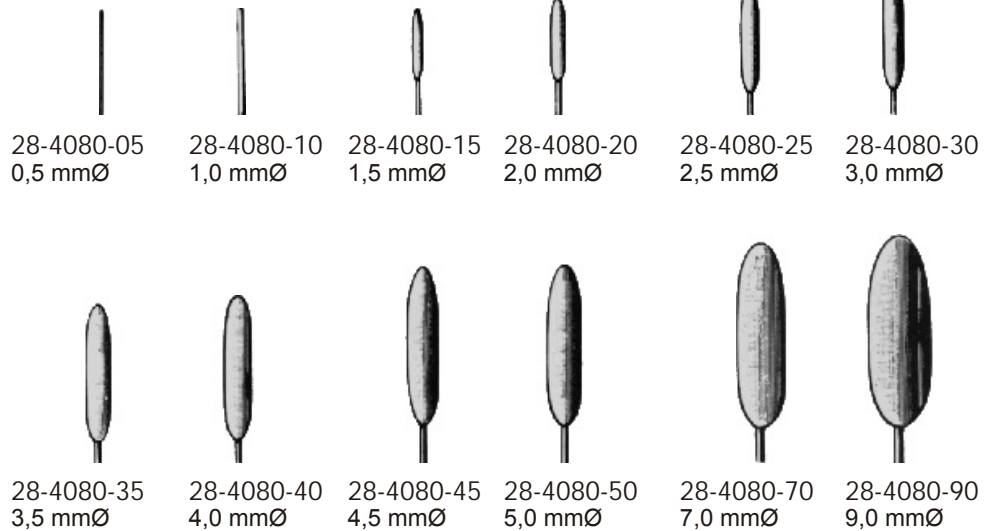

**Tracheotomie
Tracheotomy
Trachéotomie
Traqueotomía**

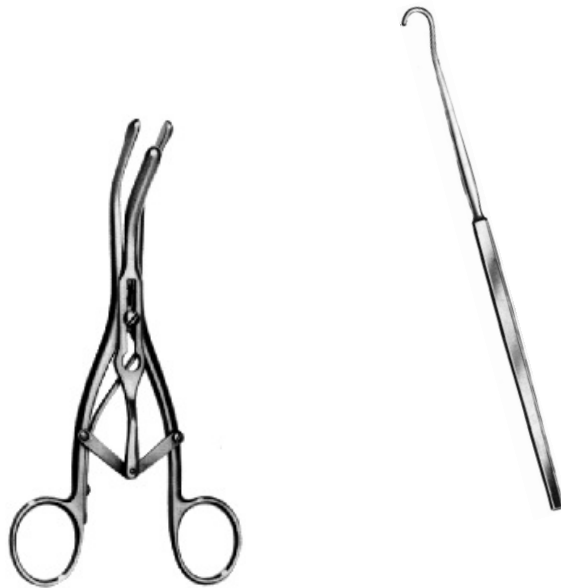

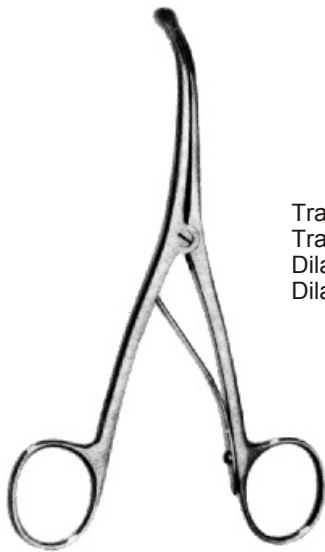

Trousseau

29-4100
14,0 cm/5½"

Tracheal-Dilatatoren
Trachea Dilators
Dilatateurs pour la trachéotomie
Dilatadores para la tráquea

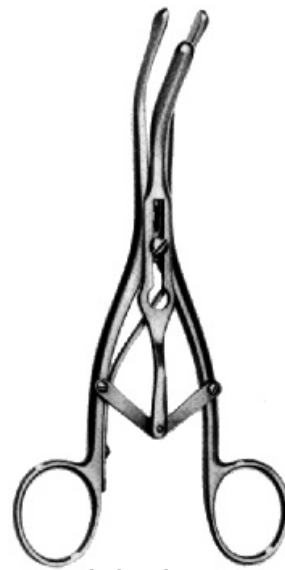

Laborde

29-4101
14,0 cm/5½"

Tracheal-Häkchen, Trachea Retractors, Crochets pour la trachéotomie, Ganchos para la tráquea



links
left
gauche
izquierda

½

Bose

29-4110-01
16,0 cm/6¼"



rechts
right
droit
derecha

½

Bose

29-4110-02
16,0 cm/6¼"



spitz
sharp
pointu
agudo

½

Iterson

29-4112-01
16,0 cm/6¼"



stumpf
blunt
mousse
romo

½

Iterson

29-4112-02
16,0 cm/6¼"



Jackson

29-4113
15,0 cm/6"

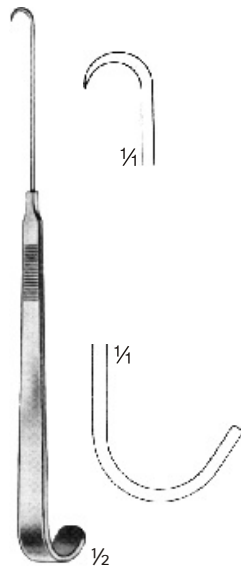

News

29-4114
15,0 cm/6"

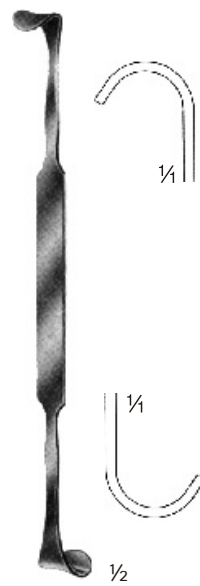

Rose

29-4115
13,5 cm/5"

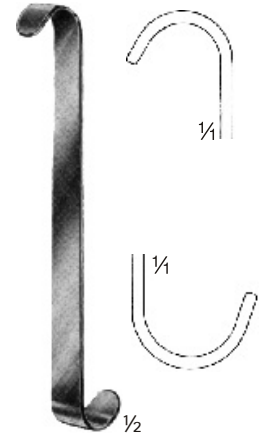

Luer

29-4116
11,0 cm/4½"



Lukens

29-4117
17,0 cm/6¾"



Jackson

29-4118
17,0 cm/6¾"



Schoenborn

29-4119
21,0 cm/8¼"

Schilddrüsenhaken
Thyroid Gland Retractor
Ecarteur pour la thyroïde
Separador para la glándula tiroidea

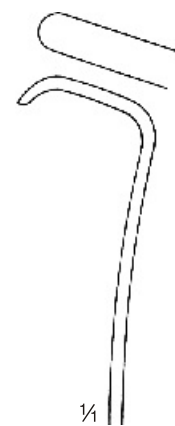

T T

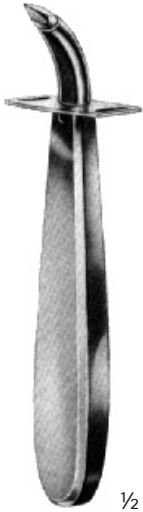

1/2

Uckermann
13,0 cm/5"



29-4120-07
7,5 mmØ



29-4120-09
9 mmØ

Tracheal-Trokare
Trachea Trocars
Trocartes pour la trachéotomie
Trocares para la tráquea



Kropffaßzange
Goitre Grasping Forceps
Pincas à goitre
Pinzas cogger-bocio

Lahey

29-4150-15
15,0 cm/6"

29-4150-20
20,0 cm/8"

Tracheal-Kanülen
Trachea Tubes
Canules pour la trachéotomie
Cánulas traqueales



Chevalier-Jackson

Fig.	L mm	Ø mm	Neusilber German silver Maillechort Plata nueva	Silber Silver Argent Plata
0	45	4	29-4130-01	29-4130-02
1	50	5	29-4131-01	29-4131-02
2	55	6	29-4132-01	29-4132-02
3	60	7	29-4133-01	29-4133-02
4	65	8	29-4134-01	29-4134-02
5	70	9	29-4135-01	29-4135-02
6	75	10	29-4136-01	29-4136-02
7	80	11	29-4137-01	29-4137-02
8	85	12	29-4138-01	29-4138-02
9	90	13	29-4139-01	29-4139-02

Narkose
Anaesthesia
Anesthésie
Anestesia





McIntosh

30-4200
Laryngoskopie-Besteck, bestehend aus:
Laryngoscope set, consisting of:
Trousse à laryngoscopie, composée de:
Juego para laryngoscopia, compuesto de:

Etui, case, boîte, estuche (30-4205-03)
Griff, handle, manche, mango (30-4225-01)
Spatel, blades, spatules, hojas
Fig. 1 (30-4203-01)
Fig. 2 (30-4203-02)
Fig. 3 (30-4203-03)



McIntosh

30-4202
Laryngoskopie-Besteck, bestehend aus:
Laryngoscope set, consisting of:
Trousse à laryngoscopie, composée de:
Juego para laryngoscopia, compuesto de:

Etui, case, boîte, estuche (30-4205-04)
Griff, handle, manche, mango (30-4225-01)
Spatel, blades, spatules, hojas
Fig. 1 (30-4203-01)
Fig. 2 (30-4203-02)
Fig. 3 (30-4203-03)
Fig. 4 (30-4203-04)

30-4205-03
Etui allein, passend für McIntosh Spatel und Griff
Case only, for McIntosh blades and handle
Boîte seule, pour McIntosh spatules et manche
Estuche solo, para McIntosh hojas y mango
Fig. 1 (30-4203-01)
Fig. 2 (30-4203-02)
Fig. 3 (30-4203-03)

30-4205-04
Etui allein, passend für McIntosh Spatel und Griff
Case only, for McIntosh blades and handle
Boîte seule, pour McIntosh spatules et manche
Estuche solo, para McIntosh hojas y mango
Fig. 1 (30-4203-01)
Fig. 2 (30-4203-02)
Fig. 3 (30-4203-03)
Fig. 4 (30-4203-04)

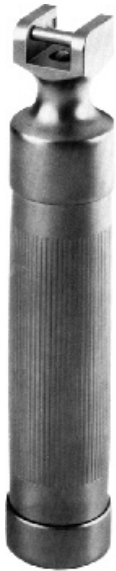

30-4225-01

Griff
Handle
Manche
Mango



30-4227-01

Ersatzbirne klein, 2,5 V
Spare bulb small, 2,5 V
Lampe de rechange petite, 2,5 V
Bombilla de repuesto pequeña, 2,5 V



30-4227-02

Ersatzbirne groß, 2,5 V
Spare bulb large, 2,5 V
Lampe de rechange grande, 2,5 V
Bombilla de repuesto grande, 2,5 V

McIntosh

← 75 mm →



Fig. 0
30-4203-00

← 90 mm →



Fig. 1
30-4203-01

← 110 mm →



Fig. 2
30-4203-02

← 130 mm →



Fig. 3
30-4203-03

← 150 mm →



Fig. 4
30-4203-04



Miller

30-4210
Laryngoskopie-Besteck, bestehend aus:
Laryngoscope set, consisting of:
Trousse à laryngoscopie, composée de:
Juego para laryngoscopia, compuesto de:

Etui, case, boîte, estuche (30-4213)
Griff, handle, manche, mango (30-4225-01)
Spatel, blades, spatules, hojas
Fig. 0 (30-4212-00)
Fig. 1 (30-4212-01)
Fig. 2 (30-4212-02)
Fig. 3 (30-4212-03)
Fig. 4 (30-4212-04)

30-4213
Etui allein, passend für Miller Spatel und Griff
Case only, for Miller blades and handle
Boîte seule, pour Miller spatules et manche
Estuche solo, para Miller hojas y mango
Fig. 0 (30-4212-00)
Fig. 1 (30-4212-01)
Fig. 2 (30-4212-02)
Fig. 3 (30-4212-03)
Fig. 4 (30-4212-04)

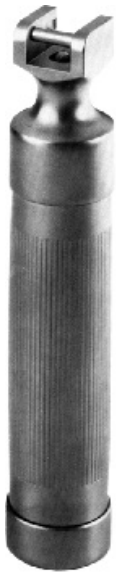

30-4225-01

Griff
Handle
Manche
Mango



30-4227-01

Ersatzbirne klein, 2,5 V
Spare bulb small, 2,5 V
Lampe de rechange petite, 2,5 V
Bombilla de repuesto pequeña, 2,5 V



30-4227-02

Ersatzbirne groß, 2,5 V
Spare bulb large, 2,5 V
Lampe de rechange grande, 2,5 V
Bombilla de repuesto grande, 2,5 V

Miller

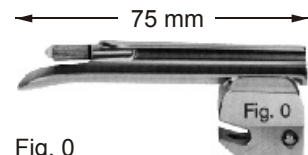

Fig. 0
30-4212-00



Fig. 1
30-4212-01

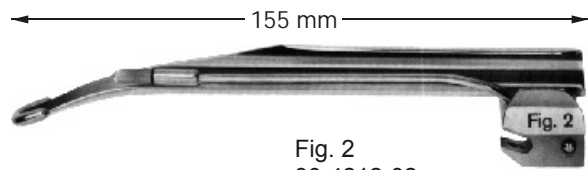

Fig. 2
30-4212-02

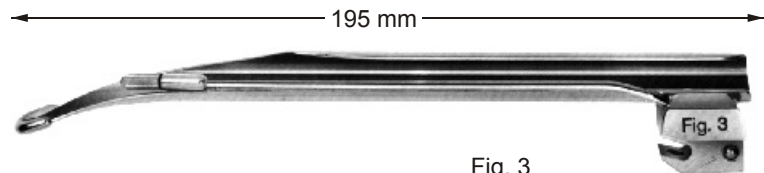

Fig. 3
30-4212-03

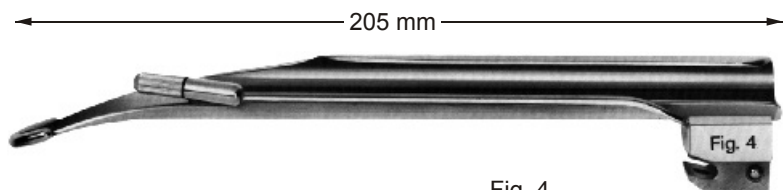

Fig. 4
30-4212-04

Etuis auf Anfrage erhältlich
 Cases available on request
 Boîtes sont disponibles à demande
 Estuches están disponibles a pregunta

Foregger



30-4227-01

Ersatzbirne klein, 2,5 V
 Spare bulb small, 2,5 V
 Lampe de rechange petite, 2,5 V
 Bombilla de repuesto pequeña, 2,5 V



30-4227-02

Ersatzbirne groß, 2,5 V
 Spare bulb large, 2,5 V
 Lampe de rechange grande, 2,5 V
 Bombilla de repuesto grande, 2,5 V

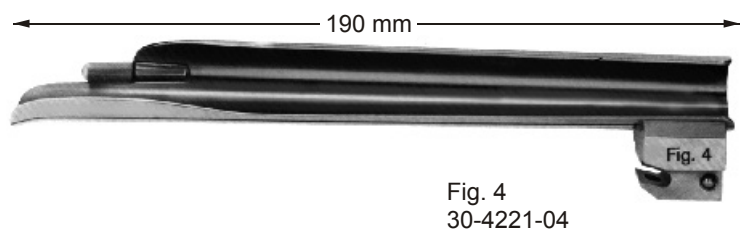

Griff mit Trafoanschluß
Handle with transformer connection
Manche avec connexion de transformation
Mango con conexión al transformador

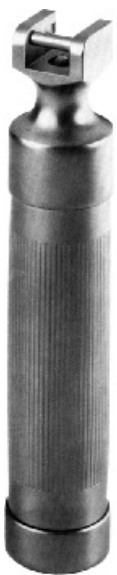

30-4225-01
30 mmØ

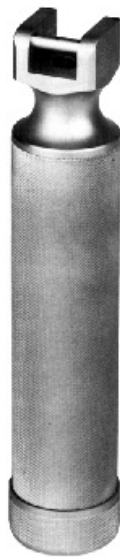

30-4225-02
30 mmØ



30-4225-03
18 mmØ



30-4226
30 mmØ



McIntosh

30-4240

Laryngoskopie-Besteck, bestehend aus:
Laryngoscope set, consisting of:
Trousse à laryngoscopie, composée de:
Juego para laryngoscopia, compuesto de:

Etui, case, boîte, estuche (30-4205-03)
Griff, handle, manche, mango (30-4266-01)
Spatel, blades, spatules, hojas
Fig. 1 (30-4243-01)
Fig. 2 (30-4243-02)
Fig. 3 (30-4243-03)

30-4205-03

Etui allein, passend für McIntosh Spatel und Griff
Case only, for McIntosh blades and handle
Boîte seule, pour McIntosh spatules et manche
Estuche solo, para McIntosh hojas y mango
Fig. 1 (30-4243-01)
Fig. 2 (30-4243-02)
Fig. 3 (30-4243-03)

30-4205-04

Etui allein, passend für McIntosh Spatel und Griff
Case only, for McIntosh blades and handle
Boîte seule, pour McIntosh spatules et manche
Estuche solo, para McIntosh hojas y mango
Fig. 1 (30-4243-01)
Fig. 2 (30-4243-02)
Fig. 3 (30-4243-03)
Fig. 4 (30-4243-04)

McIntosh

← 75 mm →



← 90 mm →



← 110 mm →



← 130 mm →



← 150 mm →





Miller

30-4250

Laryngoskopie-Besteck, bestehend aus:

Laryngoscope set, consisting of:

Trousse à laryngoscopie, composée de:

Juego para laryngoscopia, compuesto de:

Etui, case, boîte, estuche (30-4213)

Griff, handle, manche, mango (30.4266-01)

Spatel, blades, spatules, hojas

Fig. 0 (30-4253-00)

Fig. 1 (30-4253-01)

Fig. 2 (30-4253-02)

Fig. 3 (30-4253-03)

Fig. 4 (30-4253-04)

30-4213

Etui allein, passend für Miller Spatel und Griff

Case only, for Miller blades and handle

Boîte seule, pour Miller spatules et manche

Estuche solo, para Miller hojas y mango

Fig. 0 (30-4253-00)

Fig. 1 (30-4253-01)

Fig. 2 (30-4253-02)

Fig. 3 (30-4253-03)

Fig. 4 (30-4253-04)

Miller

75 mm



Fig. 0
30-4253-00

100 mm

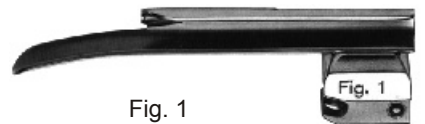

Fig. 1
30-4253-01

155 mm



Fig. 2
30-4253-02

195 mm



Fig. 3
30-4253-03

205 mm



Fig. 4
30-4253-04



Etuis auf Anfrage erhältlich
Cases available on request
Boîtes sont disponibles à demande
Estuches están disponibles a pregunta

Foregger

← 92 mm →



Fig. 0
30-4263-00

← 115 mm →



Fig. 1
30-4263-01

← 130 mm →



Fig. 2
30-4263-02

← 160 mm →



Fig. 3
30-4263-03

← 190 mm →



Fig. 4
30-4263-04



30-4267

640 mA
Halogenlampe für Kaltlichtgriffe
Halogen-light for cold light handles
Halogen lampe pour manches de lumière froide
Halogen-lámpara para mangos de luz fría



30-4266-01
30 mmØ



30-4266-02
18 mmØ



30-4268
30 mmØ



mit 1,4 m Kabel
with 1,4 m cable
avec 1,4 m câble
con 1,4 m cable

30-4270-01
220 V

30-4270-02
110 V

Griff mit Trafoanschluß
Handle with transformer connection
Manche avec connexion de transformation
Mango con conexión al transformador

Transformator
Transformer
Transformateur
Transformador





**Magen und Darm
Stomach, Intestine
Estomac, Intestin
Estómago, Intestino**





 4:5
31-4300 15,0 cm/6"

 5:6
31-4302 15,0 cm/6"
31-4303 19,0 cm/7½"
31-4304 25,0 cm/10"
31-4313 22,0 cm/8¾"

 3:4
31-4308 15,0 cm/6"

Allis



 4:5

Allis-Baby

31-4301-13 13,0 cm/5"
31-4301-14 14,0 cm/5½"

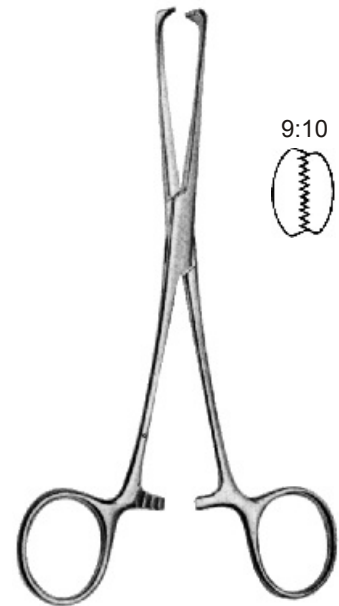

9:10



Allis-Adair

31-4305 15,5 cm/6"

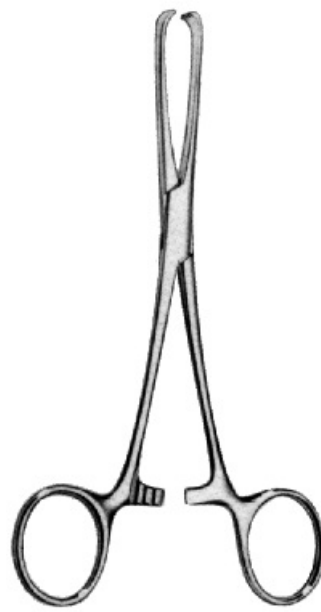

Judd-Allis

31-4306 15,0 cm/6"
31-4307 19,0 cm/7½"



Boys-Allis

31-4309 15,0 cm/6"



Thoms-Allis

31-4310 20,0 cm/8"



Lockwood-Allis

31-4311 16,0 cm/6¼"
31-4312 20,0 cm/8"

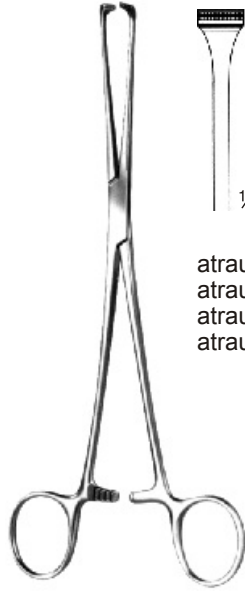

atraumatisch
atraumatic
atraumatique
atraumática

Allis

31-4315-15 15,5 cm/6¼"
31-4315-20 20,0 cm/8"
31-4315-22 22,0 cm/9"
31-4315-25 25,0 cm/10"



Babcock

31-4319 14,0 cm/5½" (Baby)
31-4320 16,0 cm/6¼"
31-4321 18,0 cm/7"
31-4322 20,0 cm/8"
31-4323 24,0 cm/9½"



atraumatisch
atraumatic
atraumatique
atraumática

31-4324-16
16,0 cm/6¼"

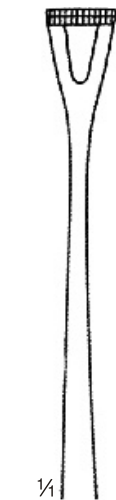

31-4324-21
21,0 cm/8¼"

Darmfaßzange
Intestinal Forceps
Pincés pour saisir l'intestin
Pinzas para coger intestinos

Babcock



Darmfaßzange
Intestinal Forceps
Pincés pour saisir l'intestin
Pinzas para coger intestinos

Williams

31-4330 20,0 cm/8"



Pylorusspreizer
Pylorus spreader
Ecarteur du pylore
Separador para piloro

Benson

31-4332 15,5 cm/6"



Doyen



¼

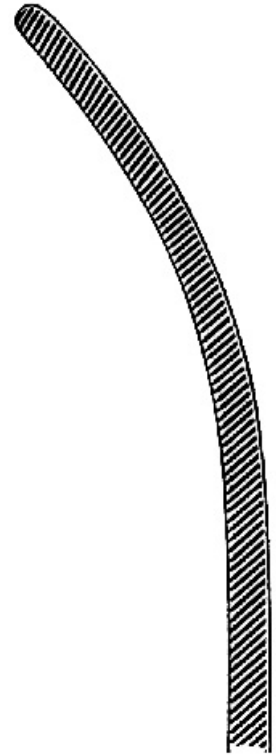

31-4399	17,0 cm/6¾"	31-4400
31-4401	21,0 cm/8¼"	31-4403
31-4402	23,0 cm/9"	31-4404

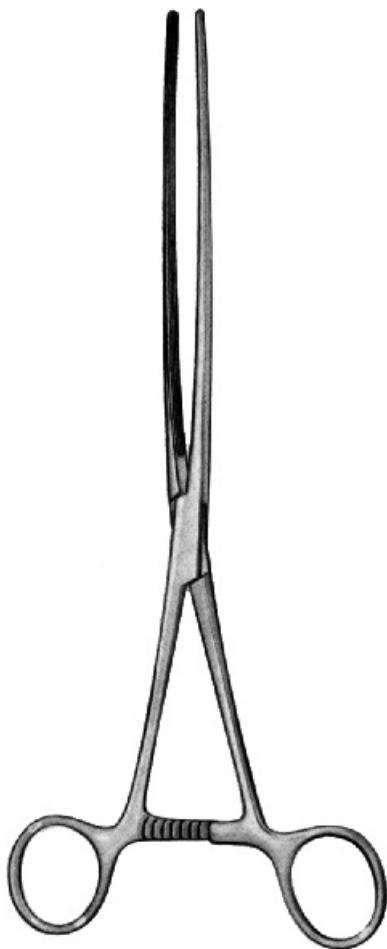

Mayo-Robson



¼



31-4405	21,0 cm/8¼"	31-4408
31-4406	23,0 cm/9"	31-4409
31-4407	25,0 cm/10"	31-4410

s
se
is



Kocher



Darmklemmen
Intestinal Clamp Forceps
Pinces-clamps intestinales
Pinzas-clamps intestinales

31-4411-22	22,0 cm/8 ³ / ₄ "	31-4412-22
31-4411-25	25,0 cm/10"	31-4412-25
31-4411-28	28,0 cm/11"	31-4412-28



Anastomosenklemmen
Anastomosis Clamp Forceps
Pinces-clamps pour l'anastomose
Pinzas-clamps para anastomosis

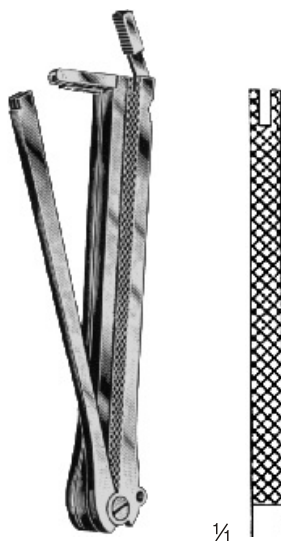

Maullänge
Length of jaw
Longueur du mors
Longitud de boca

	cm	in.	
Satz zu 3 Klemmen	5	2	31-4415-05
Set of 3 clamps	7	2 ³ / ₄	31-4415-07
Jeu de 3 clamps	10	4	31-4415-10

De Martel-Wolfson

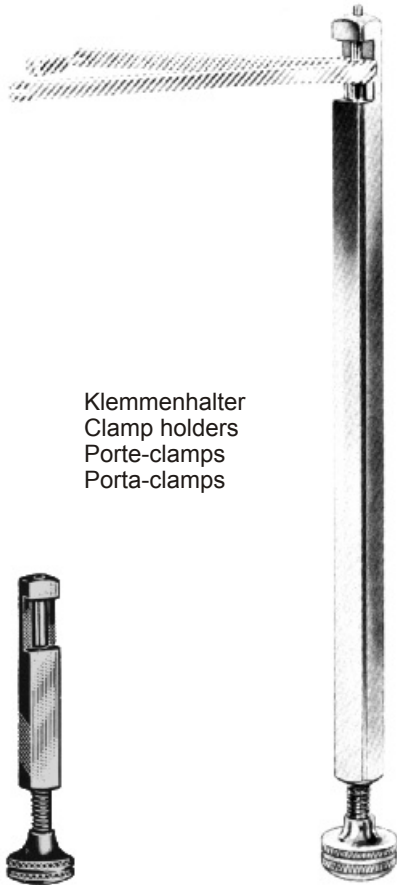

Klemmenhalter
Clamp holders
Porte-clamps
Porta-clamps

De Martel-Wolfson

31-4416-08
8,5 cm/3½"

De Martel-Wolfson

31-4416-23
23,0 cm/9"



Klemmschließzange
Clamp Closing Forceps
Pinces pour fermer les clamps
Pinzas para cerrar clamps

De Martel-Wolfson

31-4417-26
26,0 cm/10¼"

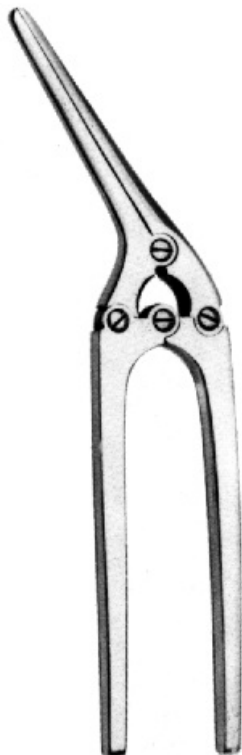

Darm- und Magenquetschklemme
Intestinal and Stomach Clamp
Pinces-clamps pour l'intestin et l'estomac
Pinzas-clamps intestinales y estomacales

ohne Stift
without pin
sans cheville
sin espiga

31-4420 15,0 cm/6"
31-4422 21,0 cm/8¼"
31-4424 29,0 cm/11½"
31-4426 35,0 cm/13¾"

mit Stift
with pin
avec cheville
con espiga

31-4421
31-4423
31-4425
31-4427

Payr





Doyen

- 31-4430-13 13,0 cm/5¼"
- 31-4430-16 16,0 cm/6¼"
- 31-4430-18 18,0 cm/7"
- 31-4430-21 21,0 cm/8½"
- 31-4430-23 23,0 cm/9"

atraumatisch
atraumatic
atraumatique
atraumática

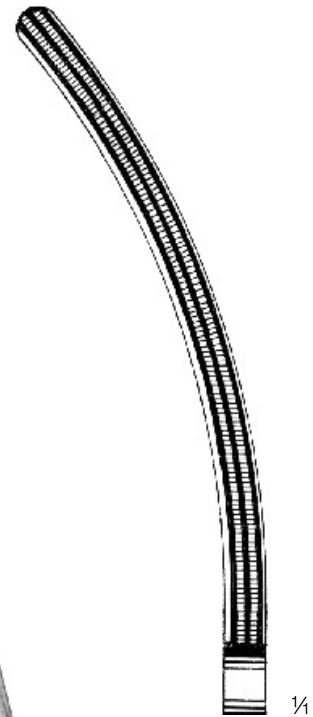

Doyen

- 31-4431-13 13,0 cm/5¼"
- 31-4431-16 16,0 cm/6¼"
- 31-4431-18 18,0 cm/7"
- 31-4431-21 21,0 cm/8½"
- 31-4431-23 23,0 cm/9"

atraumatisch
atraumatic
atraumatique
atraumática



Mayo-Robson

atraumatisch
atraumatic
atraumatique
atraumática



¼

31-4432-25
25,0 cm/10"

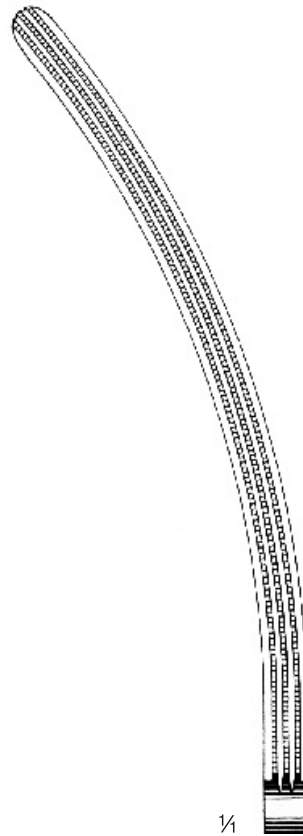

¼

31-4433-25
25,0 cm/10"

1
3



Kocher

atraumatisch
 atraumatic
 atraumatique
 atraumática

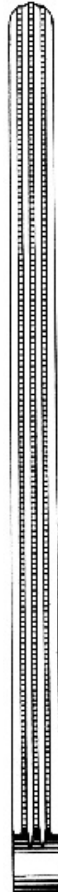

¼

31-4434-22 22,0 cm/8¾"
 31-4434-22 25,0 cm/10"
 31-4434-22 28,0 cm/11"



¼

31-4435-22 22,0 cm/8¾"
 31-4435-25 25,0 cm/10"
 31-4435-28 28,0 cm/11"

Galle, Niere, Urologie
Bile, Kidney, Urology
Bile, Rein, Urologie
Vesícula biliar, Riñon, Urología





Fig. 1

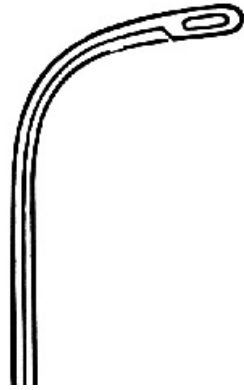

Fig. 2

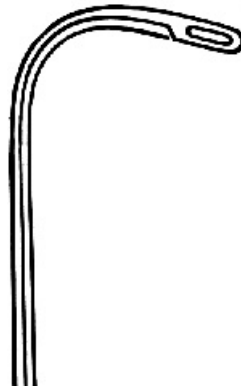

Fig. 3

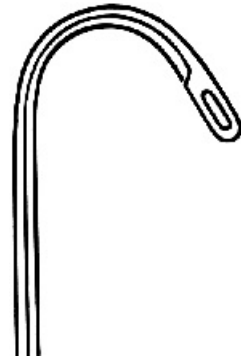

Fig. 4

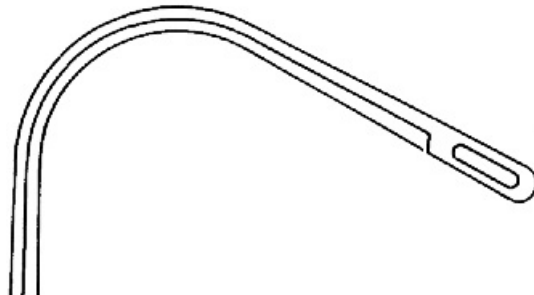

Fig. 5

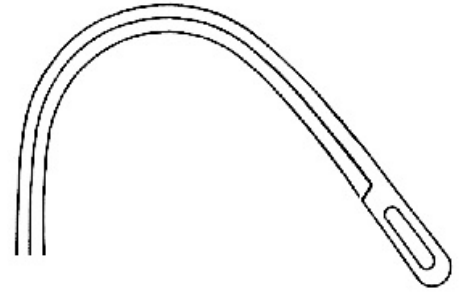
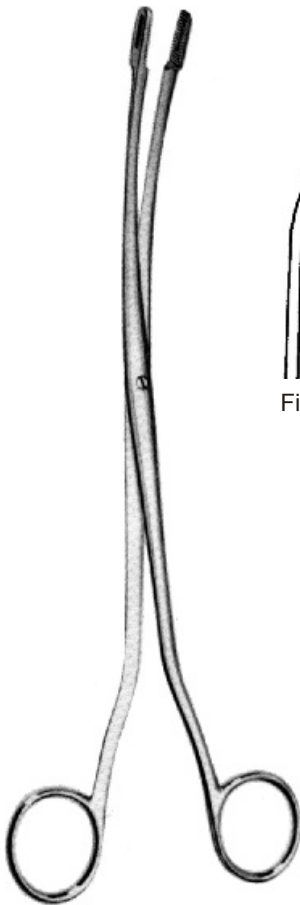

Fig. 6



Randall

Fig. 1	32-4450	23,0 cm/9"
Fig. 2	32-4451	22,0 cm/8 ³ / ₄ "
Fig. 3	32-4452	22,0 cm/8 ³ / ₄ "
Fig. 4	32-4453	22,0 cm/8 ³ / ₄ "
Fig. 5	32-4454	19,0 cm/7 ¹ / ₂ "
Fig. 6	32-4455	19,0 cm/7 ¹ / ₂ "



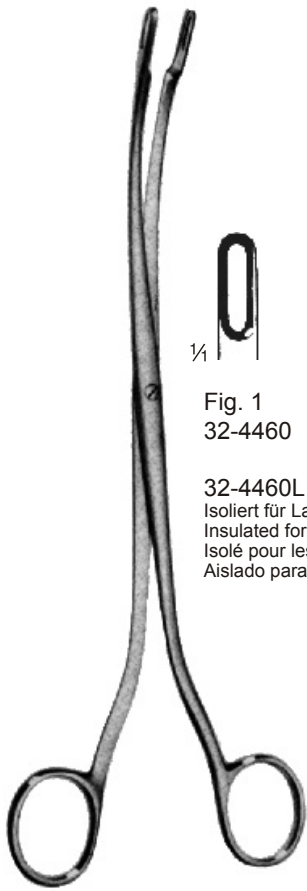

Desjardins
23,0 cm/9"

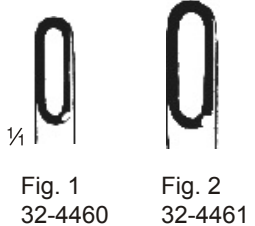
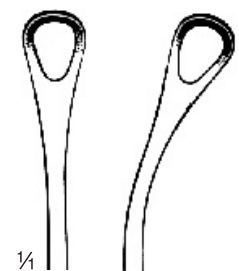

Fig. 1 32-4460
Fig. 2 32-4461

32-4460L
Isoliert für Laser- und Elektrochirurgie
Insulated for Laser- and Electrosurgery
Isolé pour les interventions au laser et électrochirurgical
Aislado para láser y electrocirugía



Blake
20,0 cm/8"



32-4462
gerade
straight
droite
recta

32-4463
gebogen
curved
courbe
curva

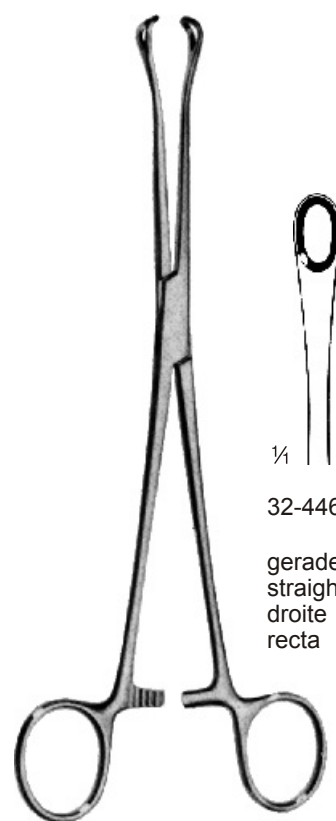

Mayo-Blake
20,0 cm/8"

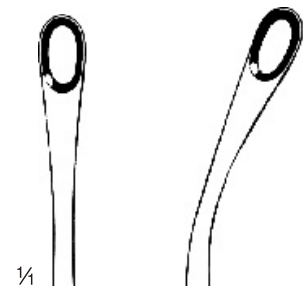

32-4464
gerade
straight
droite
recta

32-4465
gebogen
curved
courbe
curva



Mixer
32-4466
22,0 cm/8¾"



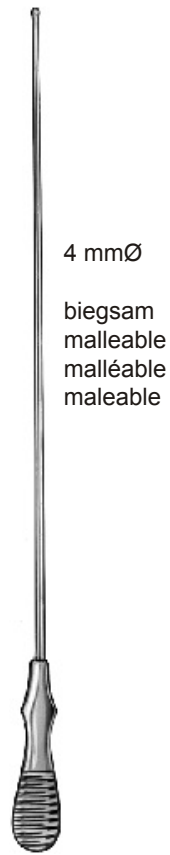

4 mmØ
 biegsam
 malleable
 malléable
 maleable

Mayo
 32-4470
 32,0 cm/12½"



4 mm 5 mm 6 mm
 ¼ ¼ ¼
 32-4471 32-4472 32-4473

federnd
 elastic
 élastique
 elástica

Desjardins
 28,0 cm/11"



biegsam
 malleable
 malléable
 maleable

Gallengangdilatoren
 Bile Duct Dilators
 Dilatateurs à voies biliaires
 Dilatadores para conducto biliar

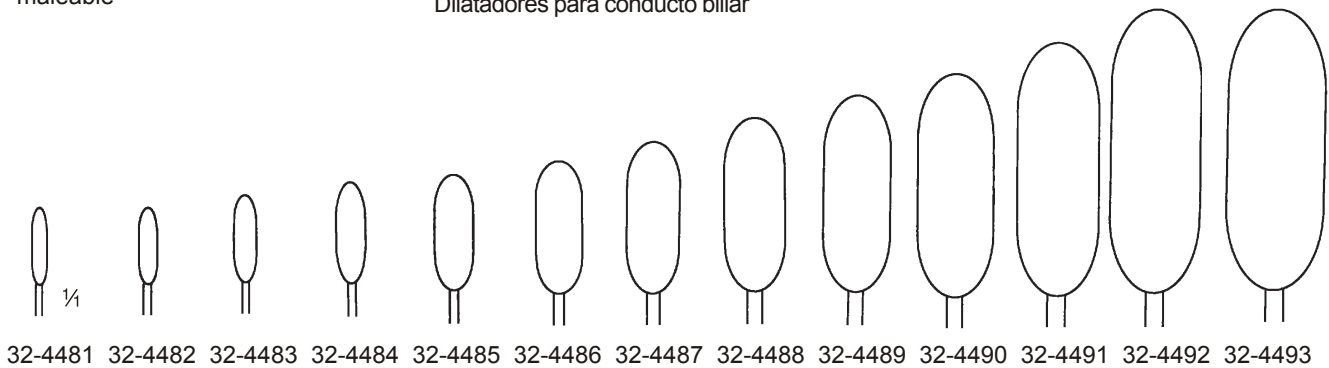

Bakes
 30,0 cm/12"

aus Kupfer
 of copper
 en cuivre
 de cobre

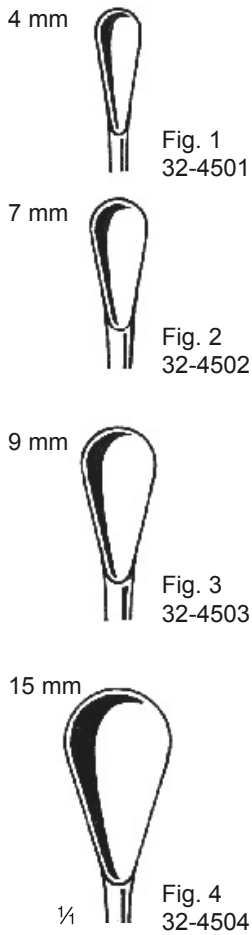

Luer-Koerte
 26,0 cm/10¹/₄"
 biegsam
 malleable
 malléable
 maleable

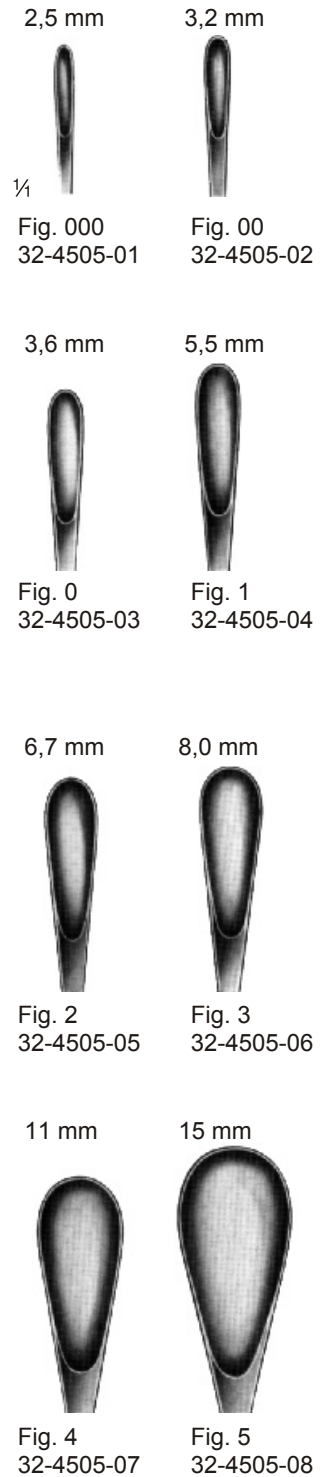

Luer-Koerte
 32,0 cm/12³/₄"
 biegsam
 malleable
 malléable
 maleable





6 mm



Fig. 1
32-4511

7 mm



Fig. 2
32-4512

8 mm



Fig. 3
32-4513

9 mm



¼
Fig. 4
32-4514

Desjardins
30,0 cm/12"
federnd
elastic
élastique
elástica



Moore
32-4520
28,0 cm/11"



Mayo
32-4525
28,0 cm/11"

Metallkatheter
Metal Catheters
Sondes métalliques
Sondas metálicas



für Männer
for male
pour hommes
para hombres

29,0 cm/11½"

Charr.

32-4600-06	6
32-4600-08	8
32-4600-10	10
32-4600-12	12
32-4600-14	14
32-4600-16	16
32-4600-18	18
32-4600-20	20
32-4600-22	22
32-4600-24	24

Katheter-Einführungsinstrument
Catheter introducing instrument
Instrument pour introduire des sondes
Instrumento para introducir catéteres



für Frauen
for female
pour femmes
para mujeres

16,0 cm/6¼"

Charr.

32-4602-06	6
32-4602-07	7
32-4602-08	8
32-4602-09	9
32-4602-10	10
32-4602-11	11
32-4602-12	12
32-4602-13	13
32-4602-14	14
32-4602-15	15
32-4602-16	16
32-4602-18	18
32-4602-20	20
32-4602-22	22
32-4602-24	24



Guyon

32-4604
36,5 cm/14½"



ohne Innengewinde
without internal thread
sans filet
sin rosca interior

mit Innengewinde
with internal thread
avec filet
con rosca interior

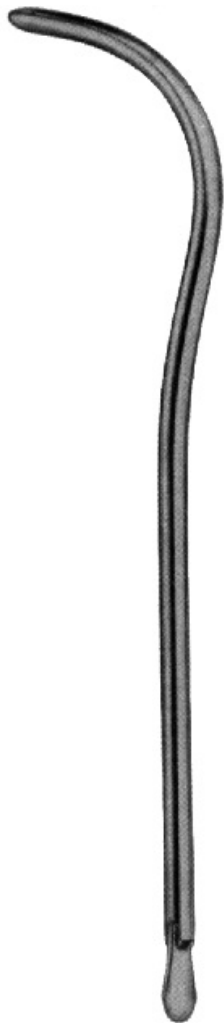

Guyon

Béniqué Nr.		Charr.
24	32-4610-24	12
25	32-4610-25	
26	32-4610-26	13
27	32-4610-27	
28	32-4610-28	14
29	32-4610-29	
30	32-4610-30	15
31	32-4610-31	
32	32-4610-32	16
33	32-4610-33	
34	32-4610-34	17
35	32-4610-35	
36	32-4610-36	18
37	32-4610-37	
38	32-4610-38	19
39	32-4610-39	
40	32-4610-40	20
41	32-4610-41	
42	32-4610-42	21
43	32-4610-43	
44	32-4610-44	22
45	32-4610-45	
46	32-4610-46	23
47	32-4610-47	
48	32-4610-48	24
49	32-4610-49	
50	32-4610-50	25
51	32-4610-51	
52	32-4610-52	26
53	32-4610-53	
54	32-4610-54	27
55	32-4610-55	
56	32-4610-56	28
57	32-4610-57	
58	32-4610-58	29
59	32-4610-59	
60	32-4610-60	30

Béniqué Nr.		Charr.
24	32-4611-24	12
25	32-4611-25	
26	32-4611-26	13
27	32-4611-27	
28	32-4611-28	14
29	32-4611-29	
30	32-4611-30	15
31	32-4611-31	
32	32-4611-32	16
33	32-4611-33	
34	32-4611-34	17
35	32-4611-35	
36	32-4611-36	18
37	32-4611-37	
38	32-4611-38	19
39	32-4611-39	
40	32-4611-40	20
41	32-4611-41	
42	32-4611-42	21
43	32-4611-43	
44	32-4611-44	22
45	32-4611-45	
46	32-4611-46	23
47	32-4611-47	
48	32-4611-48	24
49	32-4611-49	
50	32-4611-50	25
51	32-4611-51	
52	32-4611-52	26
53	32-4611-53	
54	32-4611-54	27
55	32-4611-55	
56	32-4611-56	28
57	32-4611-57	
58	32-4611-58	29
59	32-4611-59	
60	32-4611-60	30



Dittel
 35,0 cm/14"

gebogen
 curved
 courbe
 curva

Charr.

32-4613-06	6
32-4613-07	7
32-4613-08	8
32-4613-09	9
32-4613-10	10
32-4613-11	11
32-4613-12	12
32-4613-13	13
32-4613-14	14
32-4613-15	15
32-4613-16	16
32-4613-17	17
32-4613-18	18
32-4613-19	19
32-4613-20	20
32-4613-21	21
32-4613-22	22
32-4613-23	23
32-4613-24	24
32-4613-25	25
32-4613-26	26
32-4613-27	27
32-4613-28	28
32-4613-29	29
32-4613-30	30
32-4613-31	31
32-4613-32	32
32-4613-33	33
32-4613-34	34
32-4613-35	35
32-4613-36	36



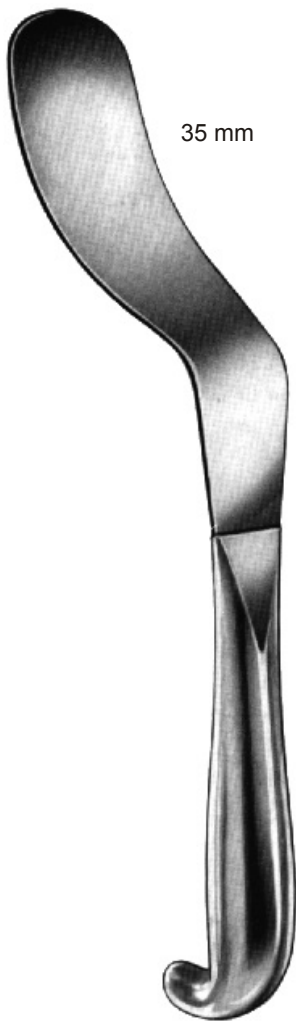

35 mm

Legue

32-4620
27,0 cm/10½"

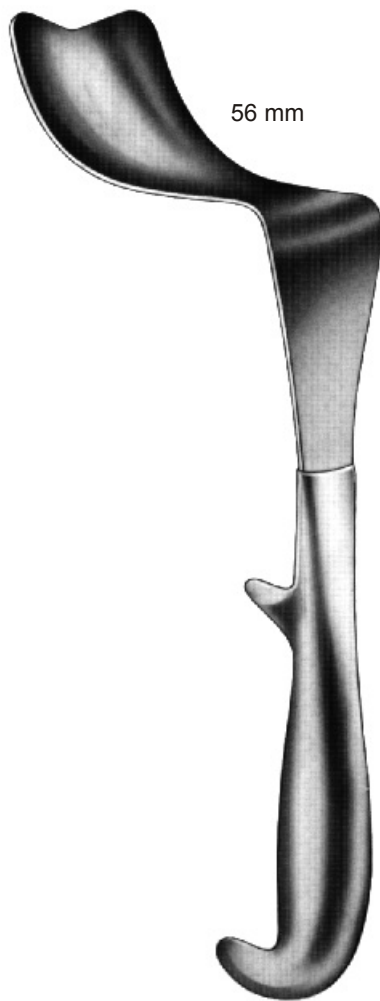

56 mm

Kocher

32-4621
26,0 cm/10¼"



67 mm

Kocher

32-4622
26,0 cm/10¼"



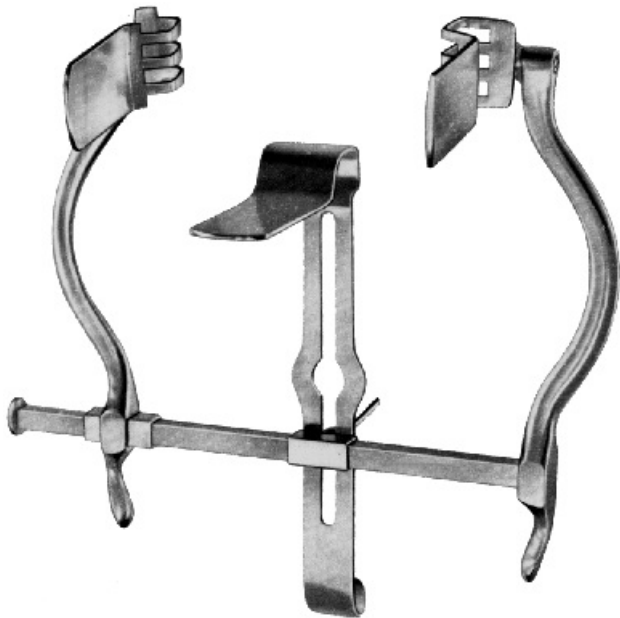

Judd-Masson
32-4625

110 mm	73 x 28 mm	73 x 28 mm
Spreizweite	Seitliche Valven	Mittelvalve
Spread	Lateral blades	Center blade
Ecartement	Valves latérales	Valve centrale
Apertura de la hoja	Valvas laterales	Valva central



Millin

32-4626-00

32-4626-10

Sperrer
Spreader
Ecarteur
Separador

bestehend aus:
consisting of:
composé de:
compuesto de:

Seitliche Valven, Lateral blades
Valves latérales, Valvas laterales
32-4626-57 57 x 25 mm
32-4626-80 80 x 25 mm

Mittelvalve, Center blade
Valve centrale, Valva central
32-4626-99 120 x 45 mm



Legueu
32-4627

95 mm	28 x 60 mm	70 x 32 mm
Spreizweite	Seitliche Valven	Mittelvalve
Spread	Lateral blades	Center blade
Ecartement	Valves latérales	Valve centrale
Apertura de la hoja	Valvas laterales	Valva central

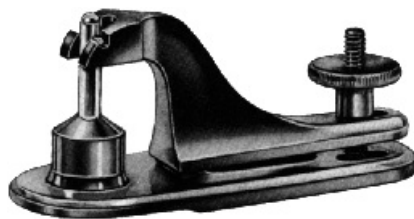

Beschneidungsinstrumente
Circumcision Instruments
Instruments de circoncision
Instrumentos para circuncisión

32-4648-08	8 mm
32-4648-11	11 mm
32-4648-13	13 mm
32-4648-16	16 mm
32-4648-21	21 mm
32-4648-26	26 mm
32-4648-32	32 mm

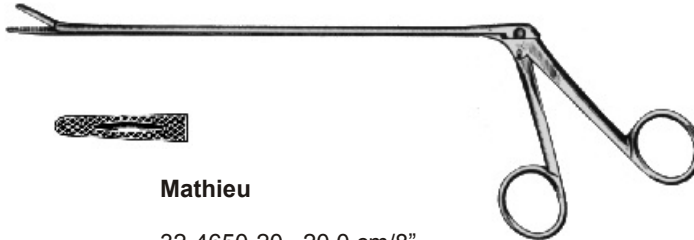

Fremdkörperzangen
Foreign Body Forceps
Pincès à corps étrangers
Pinzas para cuerpos extraños

Mathieu

32-4650-20	20,0 cm/8"
32-4650-28	28,0 cm/11"

Penisklemmen
Penis Seizing Forceps
Compresseurs de l'urètre
Compresores uretrales



Strauss

32-4656	11,0 cm/4½"
---------	-------------



Stockmann

32-4657	8,0 cm/3¼"
---------	------------

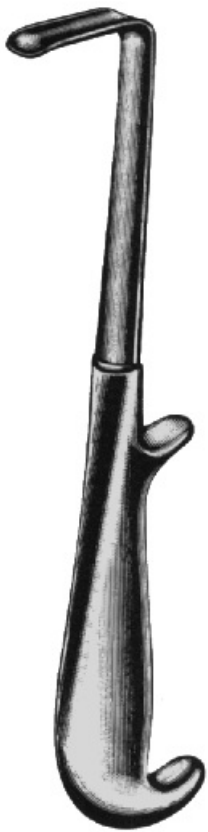

Young

32-4660
21,5 cm/8½"



Young

32-4661
21,0 cm/8½"

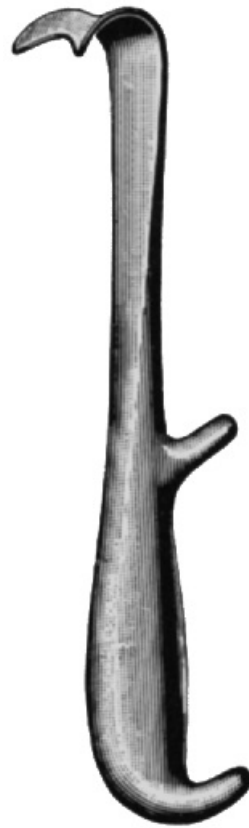

Young

32-4662
22,0 cm/8¾"



Young

32-4663
21,0 cm/8½"

32

atraumatisch
atraumatic
atraumatique
atraumática

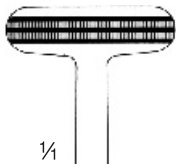

32-4670
23,5 cm/9¼"



32-4671
24,5 cm/9¾"

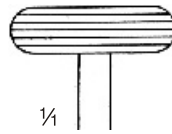

Fig. 1
32-4672-01
23,0 cm/9"

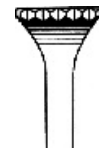

Fig. 2
32-4672-02
23,0 cm/9"

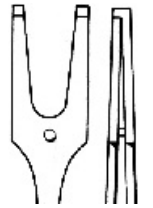
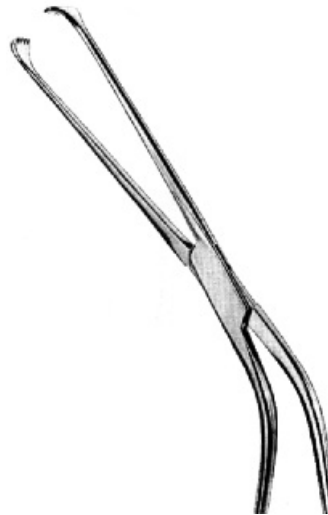

Fig. 3
32-4672-03
24,0 cm/9½"



Millin



2
3

Gynäkologie, Geburtshilfe
Gynecology, Obstetrics
Gynécologie, Accouchement
Ginecología, Obstetricia





Kristeller

33-4700

70 x 15 mm
Satz, set, jeu, juego

für Kinder
for children
pour enfants
para niños

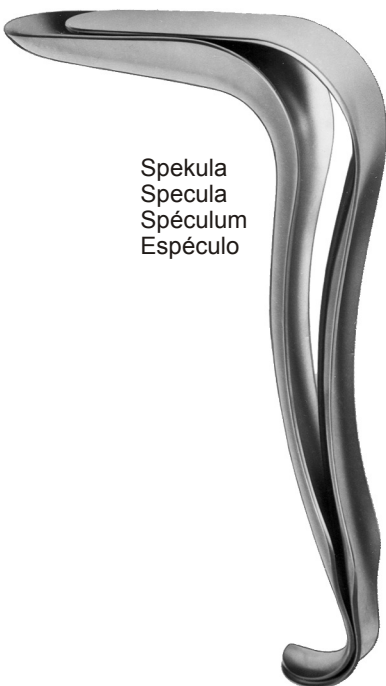

Spekula
Specula
Spéculum
Espéculo

Halter
Retractor
Valve
Valva

Kristeller
kurzes Modell
short model
modèle court
modelo corto

Satz aus je 1 Spekula und 1 Halter
Set of 1 specula and 1 retractor
Jeu de 1 spéculum et 1 valve
Juego de 1 espéculo y 1 valva

Fig. 1 33-4701
Fig. 2 33-4702
Fig. 3 33-4703

Spekula
Specula
Spéculum
Espéculo

Fig. 1 33-4701-01 70 x 27 mm
Fig. 2 33-4702-02 80 x 30 mm
Fig. 3 33-4703-03 90 x 36 mm

Halter
Retractor
Valve
Valva

Fig. 1 33-4701-11 75 x 23 mm
Fig. 2 33-4702-12 85 x 26 mm
Fig. 3 33-4703-13 100 x 32 mm



Spekula
Specula
Spéculum
Espéculo

Halter
Retractor
Valve
Valva

Satz aus je 1 Spekula und 1 Halter
Set of 1 specula and 1 retractor
Jeu de 1 spéculum et 1 valve
Juego de 1 espéculo y 1 valva

Fig. 00 33-4709

Fig. 0 33-4710

Spekula
Specula
Spéculum
Espéculo

Fig. 00 33-4709-01 105 x 18 mm

Fig. 0 33-4710-01 105 x 21 mm

Kristeller

mit konisch verlaufenden Blättern
with conically shaped blades
avec valves coniques
con valvas cónicas

Halter
Retractor
Valve
Valva

Fig. 00 33-4709-11 110 x 14 mm

Fig. 0 33-4710-11 110 x 17 mm

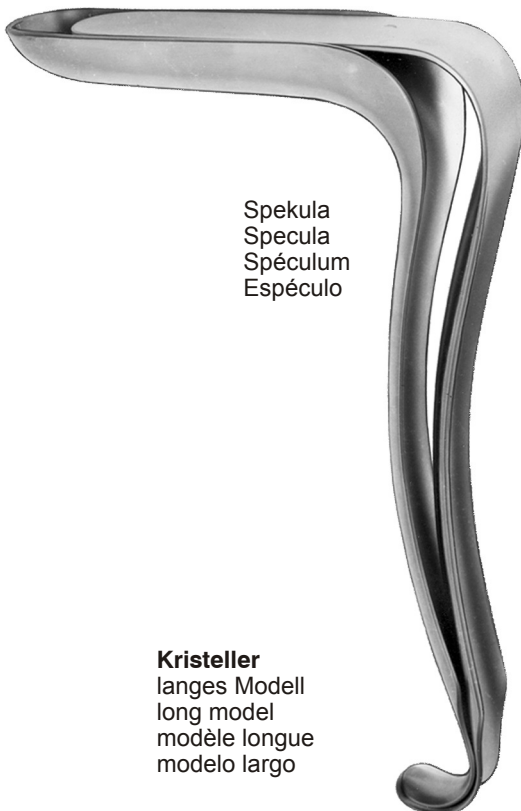

Spekula
Specula
Spéculum
Espéculo

Halter
Retractor
Valve
Valva

Satz aus je 1 Spekula und 1 Halter
Set of 1 specula and 1 retractor
Jeu de 1 spéculum et 1 valve
Juego de 1 espéculo y 1 valva

Fig. 1 33-4721

Fig. 2 33-4722

Fig. 3 33-4723

Spekula
Specula
Spéculum
Espéculo

Fig. 1 33-4721-01 105 x 26 mm

Fig. 2 33-4722-02 105 x 28 mm

Fig. 3 33-4723-03 105 x 33 mm

Kristeller

langes Modell
long model
modèle longue
modelo largo

Halter
Retractor
Valve
Valva

Fig. 1 33-4721-11 115 x 22 mm

Fig. 2 33-4722-12 115 x 24 mm

Fig. 3 33-4723-13 115 x 29 mm



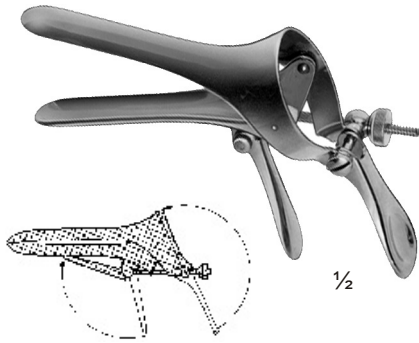

Cusco

Fig. 1 33-4800 85 x 17 mm
für Jungfrauen
for virgins
pour vierges
para virgenes

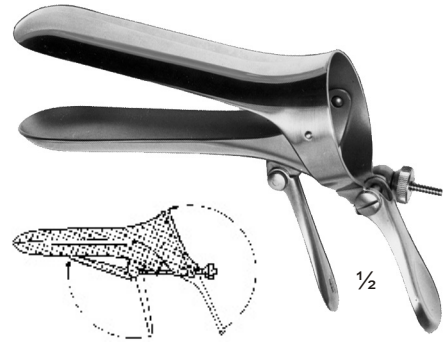

Cusco

Fig. 1 33-4801 75 x 32 mm
Fig. 2 33-4802 85 x 35 mm
Fig. 3 33-4803 100 x 35 mm

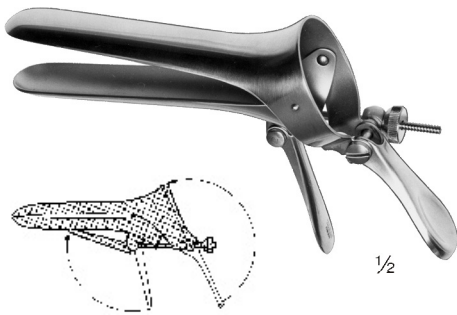

Cusco

Fig. 1 33-4805 90 x 23/25 mm
Fig. 2 33-4806 100 x 25/27 mm
Fig. 3 33-4807 110 x 27/30 mm

Schweizer Modell
Swiss pattern
Modèle suisse
Modelo suizo



Grave

Fig. 1 33-4811 85 x 33 mm
Fig. 2 33-4812 95 x 33 mm
Fig. 3 33-4813 105 x 33 mm



Seyffert
 23,0 cm/9"

- 33-4816-01 100 x 17 mm
- 33-4816-02 110 x 33 mm

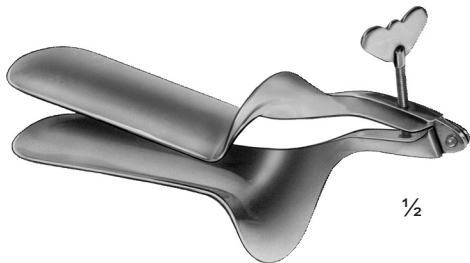

Collin

- Fig. 1** 33-4821 90 x 29 mm
- Fig. 2** 33-4822 95 x 35 mm
- Fig. 3** 33-4823 110 x 40 mm

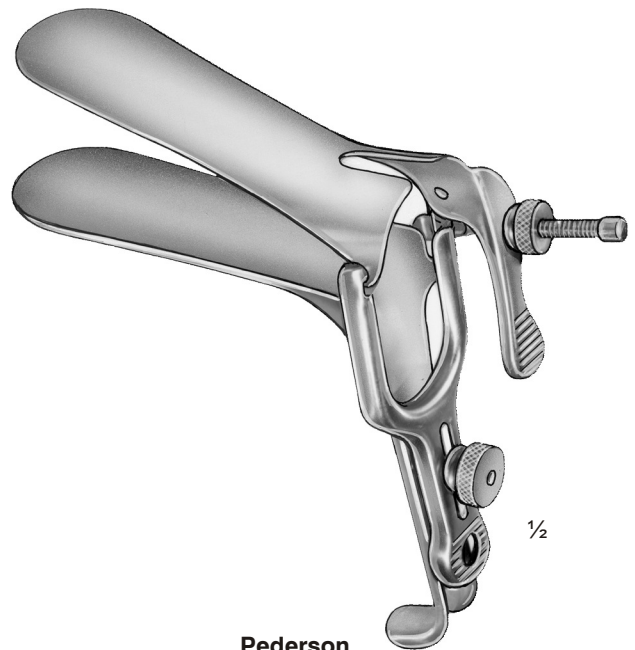

Pederson

- Fig. 1** 33-4824 75 x 13 mm
- Fig. 2** 33-4825 100 x 22 mm
- Fig. 3** 33-4826 120 x 25 mm





mit Absaugung
with smoke tube
avec tube d'aspiration
con tubo de aspiración

½

Grave

- Fig. 1** 33-4811L 85 x 33 mm
Fig. 2 33-4812L 95 x 33 mm
Fig. 3 33-4813L 105 x 33 mm



mit Absaugung
with smoke tube
avec tube d'aspiration
con tubo de aspiración

½

Pederson

- Fig. 1** 33-4824L 75 x 13 mm
Fig. 2 33-4825L 100 x 22 mm
Fig. 3 33-4826L 120 x 25 mm

Isoliert für Laser- und Elektrochirurgie 33.-Nr. + "L"
Insulated for Laser- and Electrosurgery 33-No. + "L"
Isolé pour les interventions au laser et électrochirurgical 33-No. + "L"
Aislado para láser y electrocirugía 33-No. + "L"



Semm

- Fig. 1** 33-4827 95 x 14/18 mm
Fig. 2 33-4828 100 x 20/25 mm
Fig. 3 33-4829 105 x 27/35 mm

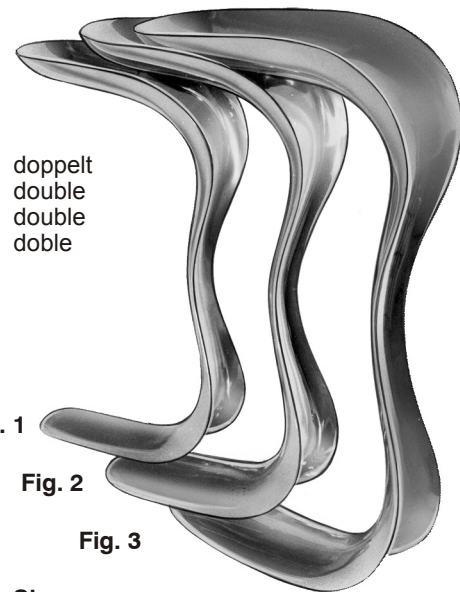

doppelt
double
double
double

Fig. 1

Fig. 2

Fig. 3

Sims

- Fig. 1** 33-4831 25 x 30 mm
Fig. 2 33-4832 30 x 35 mm
Fig. 3 33-4833 35 x 40 mm



Spekula
Specula
Spéculum
Espéculo

- Fig. 1** 33-4834-01 70 x 40 mm
Fig. 2 33-4834-02 90 x 40 mm



Halter
Retractor
Valve
Valva

- Fig. 1** 33-4835-01 70 x 33 mm
Fig. 2 33-4835-02 90 x 33 mm

Kallmorgen

Satz aus je 1 Spekula und 1 Halter
 Set of 1 specula and 1 retractor
 Jeu de 1 spéculum et 1 valve
 Juego de 1 espéculo y 1 valva

- Fig. 1** 33-4836-01 17,0 cm/6³/₄"
Fig. 2 33-4836-02 20,0 cm/8"





29,0 cm/11½"
 33-4837-20 100 x 20 mm
 33-4837-25 100 x 25 mm
 33-4837-30 100 x 30 mm
 33-4837-35 100 x 35 mm
 33-4837-40 100 x 40 mm

32,0 cm/12½"
 33-4838-20 130 x 20 mm
 33-4838-25 130 x 25 mm
 33-4838-30 130 x 30 mm
 33-4838-35 130 x 35 mm
 33-4838-40 130 x 40 mm

35,0 cm/13¾"
 33-4839 155 x 40 mm

½

Breisky



½

Doyen

33-4840 70 x 30 mm
 24,0 cm/9½"



Spekula
Specula
Spéculum
Espéculo

Halter
Retractor
Valve
Valva

Mathieu

21,0 cm/8¼"

Spekula
Specula
Spéculum
Espéculo

33-4840-01 95 x 17-30 mm

Halter
Retractor
Valve
Valva

33-4840-02 95 x 17-26 mm

½

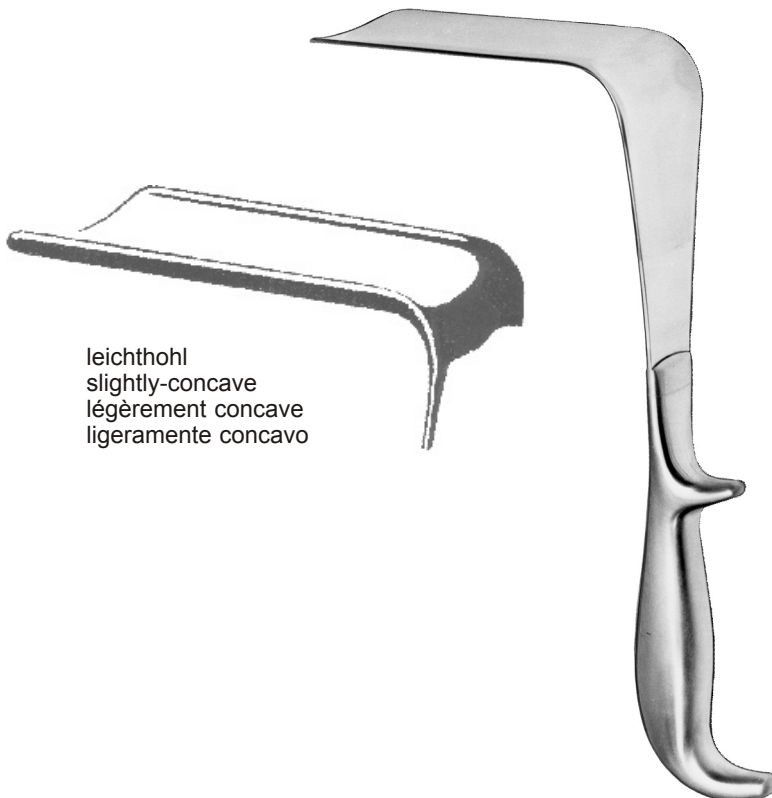

leichthohl
slightly-concave
légèrement concave
ligeramente concavo

Doyen

Fig. 1 33-4841 60 x 35 mm

Fig. 2 33-4842 90 x 35 mm

Fig. 3 33-4843 120 x 35 mm

Fig. 4 33-4844 160 x 35 mm

Fig. 1 33-4851 60 x 45 mm

Fig. 2 33-4852 90 x 45 mm

Fig. 3 33-4853 120 x 45 mm

Fig. 4 33-4854 160 x 45 mm

Fig. 1 33-4861 60 x 60 mm

Fig. 2 33-4862 90 x 60 mm

Fig. 3 33-4863 120 x 60 mm

Fig. 4 33-4864 160 x 60 mm



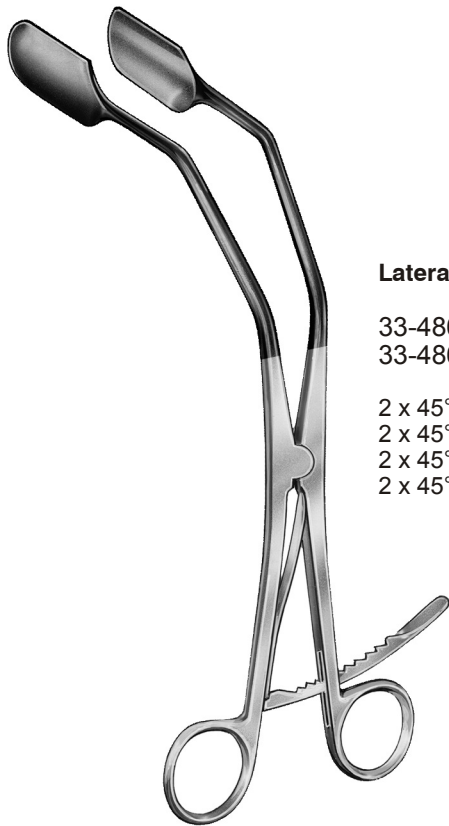

Lateral Retraktor

33-4865
33-4865L

2 x 45° gebogen
2 x 45° curved
2 x 45° courbe
2 x 45° curva

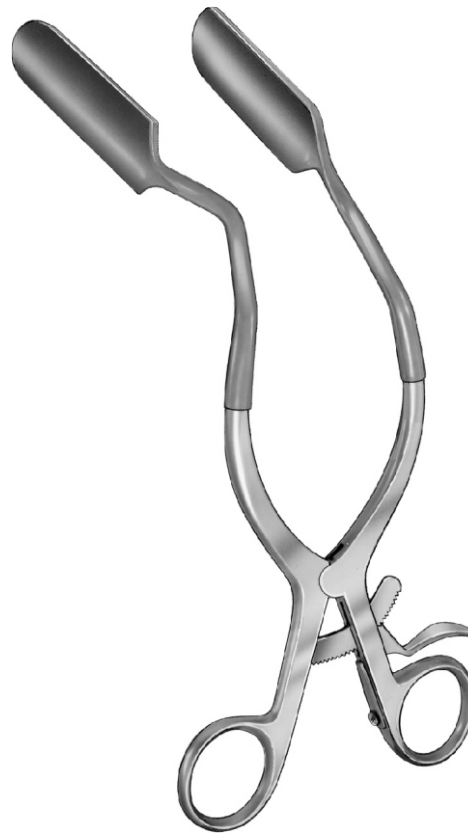

Lateral Retraktor

33-4866
33-4866L

2 x 45° gebogen
2 x 45° curved
2 x 45° courbe
2 x 45° curva

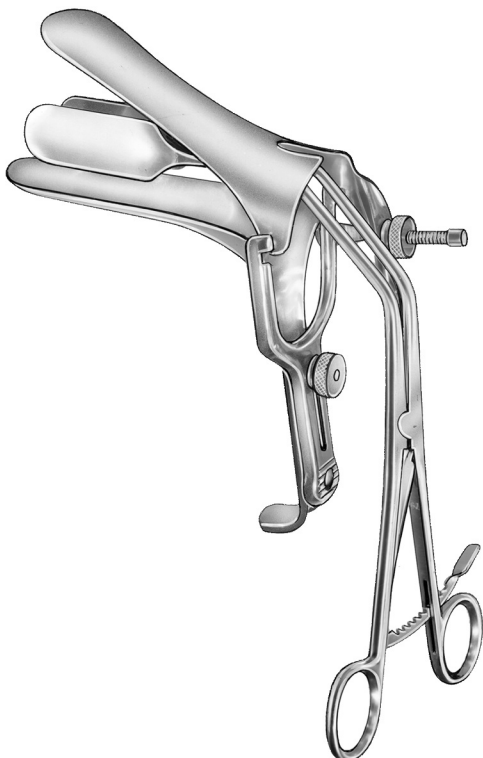

Der Lateral Vaginal-Retraktor erweitert Ihr Blickfeld und den Arbeitsbereich.

The Lateral Vaginal Retractor improves access and viewing of the cervix during a procedure.

Le spéculum latéral élargit votre angle visuel et votre sphère du travail.

El espéculo lateral amplía su campo visual y su zona de trabajo.

Isoliert für Laser- und Elektrochirurgie 33-Nr. + "L"
Insulated for Laser- and Electrosurgery 33-No. + "L"
Isolé pour les interventions au laser et électrochirurgical 33-No. + "L"
Aislado para láser y electrocirugía 33-No. + "L"

75 x 38 mm



Auvar

33-4870

mit abnehmbaren Gewicht
with detachable weight
avec poids démontable
con peso desmontable

33-4871

mit festem Gewicht
with fixed weight
avec poids fixe
con peso fijo



Scherbak

33-4873-00
Satz bestehend aus Gewicht (33-4873-40),
Griff und 5 Blättern
Set consisting of weight (33-4873-40),
handle and 5 blades
Jeu composé de poids (33-4873-40),
manche et 5 valves
Juego compuesto de peso (33-4873-40),
mango y 5 valvas

33-4873-10
Griff allein
Handle only
Manche seul
Mango suelto

33-4873-40 400 g
33-4873-80 800 g
Gewicht allein
Weight only
Poids seul
Peso suelto

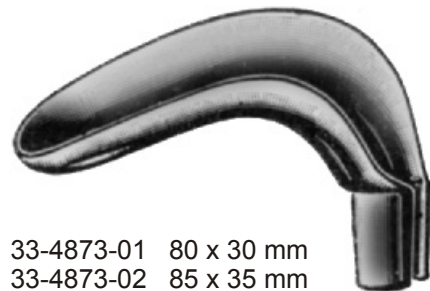

33-4873-01 80 x 30 mm
33-4873-02 85 x 35 mm
33-4873-03 90 x 40 mm



33-4873-04 55 x 40/60 mm
33-4873-05 70 x 45/70 mm





Kogan
28 cm/11"

mit Sperre
with ratchet
avec crémaillère
con cremallera

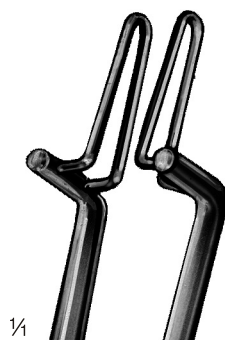

4 x 23 mm
33-4875
33-4875L

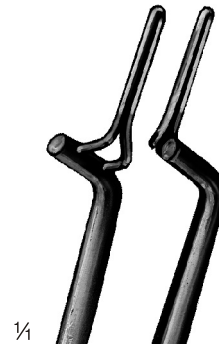

3 x 23 mm
33-4877
33-4877L

6 x 23 mm
33-4876
33-4876L

Isoliert für Laser- und Elektrochirurgie 33-Nr. + "L"
Insulated for Laser- and Electrosurgery 33-No. + "L"
Isolé pour les interventions au laser et électrochirurgical 33-No. + "L"
Aislado para láser y electrocirugía 33-No. + "L"



Kogan

33-4878
24 cm/9½"

ohne Sperre
without ratchet
sans crémaillère
sin cremallera



6 x 23 mm



Kogan

33-4879
24 cm/9½"

mit Schraubensperre
with screw ratchet
avec crémaillère de vis
con cremallera de tornillo



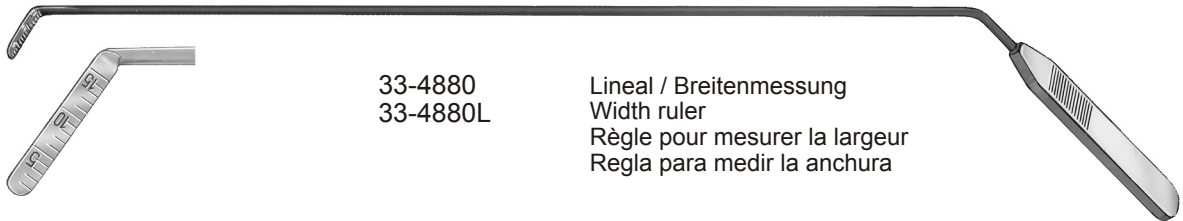

33-4880
33-4880L

Lineal / Breitenmessung
Width ruler
Règle pour mesurer la largeur
Regla para medir la anchura

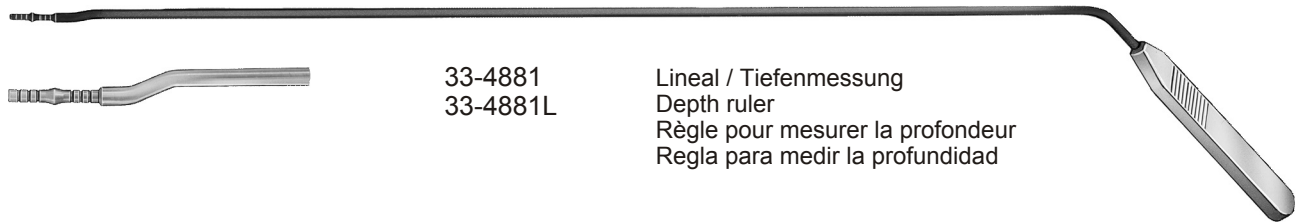

33-4881
33-4881L

Lineal / Tiefenmessung
Depth ruler
Règle pour mesurer la profondeur
Regla para medir la profundidad



33-4884
33-4884L

Emmett
Haken
Hook
Crochet
Gancho



33-4885
33-4885L

Laser Haken
Laser hook
Crochet à laser
Gancho para láser



33-4886
33-4886L

Iris Haken
Iris hook
Crochet à iris
Gancho para iris



33-4887
33-4887L

Haken, 2 Krallen
Hook, 2 claws
Crochet, 2 griffes
Gancho, 2 garras

Isoliert für Laser- und Elektrochirurgie 33-Nr. + "L"
Insulated for Laser- and Electrosurgery 33-No. + "L"
Isolé pour les interventions au laser et électrochirurgical 33-No. + "L"
Aislado para láser y electrocirugía 33-No. + "L"



	mm
33-4729-03	3
33-4729-04	4
33-4729-05	5
33-4729-06	6
33-4729-07	7
33-4729-08	8
33-4729-09	9
33-4729-10	10
33-4729-11	11
33-4729-12	12
33-4729-13	13
33-4729-14	14
33-4729-15	15
33-4729-16	16
33-4729-17	17
33-4729-18	18
33-4729-19	19
33-4729-20	20
33-4729-21	21
33-4729-22	22
33-4729-23	23

Hegar
mit gerieftem Griff und Rinne
with serrated handle and groove
avec manche strié et cannelure
con mango estriado y acanaladura



	mm		mm
33-4730	1	33-4760	1,5
33-4731	2	33-4761	2,5
33-4732	3	33-4762	3,5
33-4733	4	33-4763	4,5
33-4734	5	33-4764	5,5
33-4735	6	33-4765	6,5
33-4736	7	33-4766	7,5
33-4737	8	33-4767	8,5
33-4738	9	33-4768	9,5
33-4739	10	33-4769	10,5
33-4740	11	33-4770	11,5
33-4741	12	33-4771	12,5
33-4742	13	33-4772	13,5
33-4743	14	33-4773	14,5
33-4744	15	33-4774	15,5
33-4745	16	33-4775	16,5
33-4746	17	33-4776	17,5
33-4747	18	33-4777	18,5
33-4748	19	33-4778	19,5
33-4749	20	33-4779	20,5
33-4750	21	33-4780	21,5
33-4751	22	33-4781	22,5
33-4752	23	33-4782	23,5
33-4753	24		
33-4754	25		
33-4755	26		
33-4756	27		
33-4757	28		
33-4758	29		
33-4759	30		

Hegar
mit glattem Muldengriff
with sloped handle
avec manche aplati
con mango aplanado

Satz		Stück per Satz
Set		Pieces per set
Jeu		Pièces par jeu
Juego	mm	Piezas por juego
33-4901	4-17	14
33-4902	1-26	26





Hegar

mit glattem Muldengriff in Ledertasche
with sloped handle in leather pouch
avec manche aplati en pochette de cuir
con mango aplanado en estuche de cuero



Hegar

mit glattem Muldengriff in Metalletui
with sloped handle in metal case
avec manche aplati en boîte de métal
con mango aplanado en estuche de metal

Satz		Stück per Satz
Set		Pieces per set
Jeu		Pièces par jeu
Juego	mm	Piezas por juego
33-4903	4-17	14

Satz		Stück per Satz
Set		Pieces per set
Jeu		Pièces par jeu
Juego	mm	Piezas por juego
33-4904	4-17	14
33-4905	1-26	26

Metalletui allein, für:		Stück
Metal case only, for:		Pieces
Boîte de métal seule, pour:		Pièces
Estuche de metal suelto, para:	mm	Piezas
33-4904-10	4-17	14
33-4905-10	1-26	26



Hegar
doppelt
double
double
doble

	mm
33-4784	1/2
33-4785	3/4
33-4786	5/6
33-4787	7/8
33-4788	9/10
33-4789	11/12
33-4790	13/14
33-4791	15/16
33-4792	17/18
33-4793	19/20
33-4794	21/22
33-4795	23/24
33-4796	25/26

Satz Set Jeu Juego	mm	Stück per Satz Pieces per set Pièces par jeu Piezas por juego
33-4908	3/4 - 17/18	8
33-4909	1/2 - 25/26	13



Hegar
doppelt, double, double, doble
in Stofftasche, in canvas roll,
en pochette à toile, en estuche de tela

Satz Set Jeu Juego	mm	Stück per Satz Pieces per set Pièces par jeu Piezas por juego
33-4910	3/4 - 17/18	8



Hegar
doppelt, double, double, doble
in Metalletui, in metal case,
en boîte de métal, en estuche de metal

Satz Set Jeu Juego	mm	Stück per Satz Pieces per set Pièces par jeu Piezas por juego
33-4911	3/4 - 17/18	8
33-4912	1/2 - 25/26	13

Metalletui allein, für: Metal case only, for: Boîte de métal seule, pour: Estuche de metal suelto, para:	mm	Stück Pieces Pièces Piezas
33-4908-10	3/4 - 17/18	8
33-4909-10	1/2 - 25/26	13

Uterusdilatoren
Uterine-Dilators
Dilatateurs utérins
Dilatadores uterinos

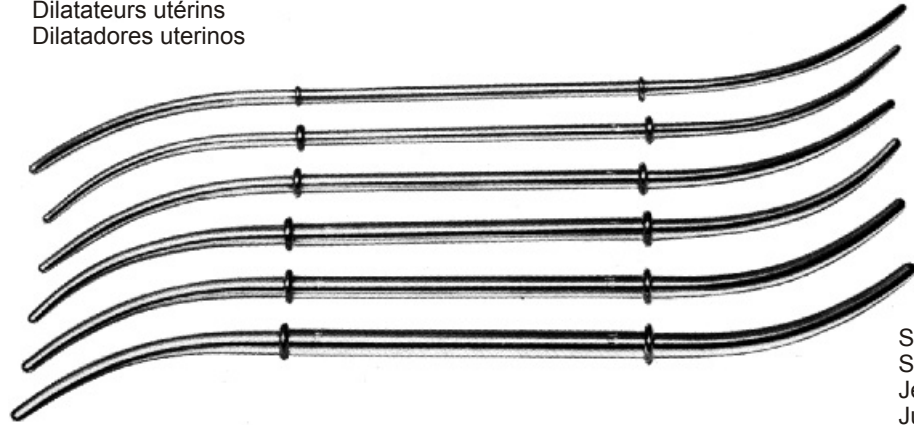

Amerikanische Skala
American scale
Echelle américaine
Escala americana

Fig.	Hank	mm
Fig. 9/10	33-4913-09	4,5/5
Fig. 11/12	33-4913-11	5,5/6
Fig. 13/14	33-4913-13	6,5/7
Fig. 15/16	33-4913-15	7,5/8
Fig. 17/18	33-4913-17	8,5/9
Fig. 19/20	33-4913-19	9,5/10

Satz	Stück per Satz
Set	Pieces per set
Jeu	Pièces par jeu
Juego	Piezas por juego
33-4913-00	6

Uterussonden
Uterine Sounds
Hystéromètres
Histerómetros



Sims
32 cm/12½"

33-4920

starr, graduiert in cm
rigid, graduated in cm
rigide, gradué en cm
rigido, graduado en cm

33-4921

biegsam, graduiert in cm
malleable, graduated in cm
malléable, gradué en cm
maleable, graduado en cm



biegsam
malleable
malléable
maleable

Martin

33-4923
32 cm/12½"

Uterus-Depressor
Uterine depressor
Depresseur utérin
Depresor uterino



Braun

33-4924
27,5 cm/11"

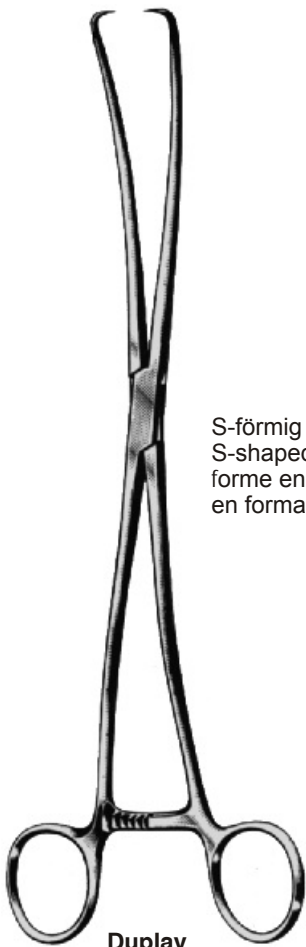

Duplay

33-4949
25,0 cm/10"

S-förmig
S-shaped
forme en S
en forma de S



Schröder-Braun
25,0 cm/10"

spitz
sharp
pointue
aguda

33-4950

33-4950L
Isoliert für Laser- und Elektrochirurgie
Insulated for Laser- and Electrosurgery
Isolé pour les interventions au laser et électrochirurgical
Aislado para láser y electrocirugía



stumpf
blunt
mousse
roma

33-4952

33-4952L



Braun

33-4951
25,0 cm/10"



Skene

33-4953
24,0 cm/9½"





Staude-Moore

33-4954
17,0 cm/6¾"

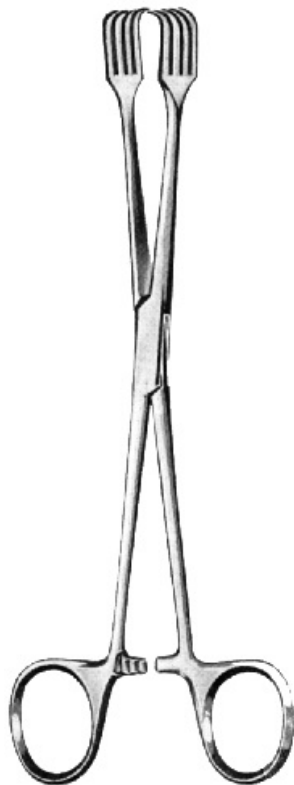

Czerny

33-4959
20,0 cm/8"

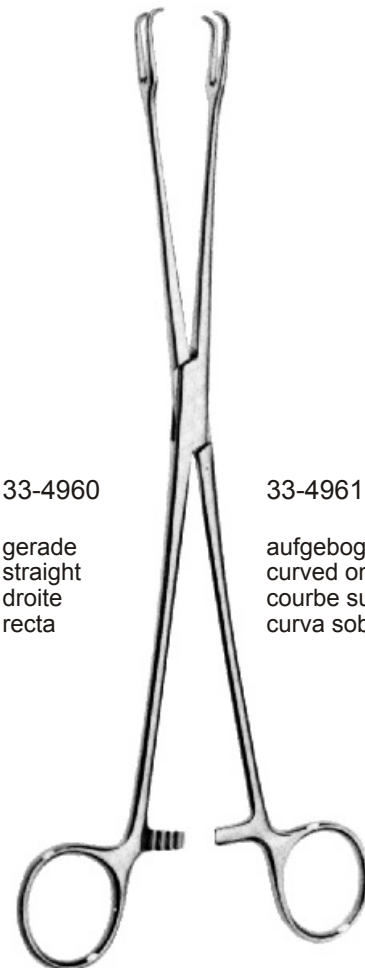

33-4960

gerade
straight
droite
recta

33-4961

aufgebogen
curved on flat
courbe sur le plat
curva sobre el plano

Schröder
24,0 cm/9½"



Teale
 33-4962
 23,0 cm/9"

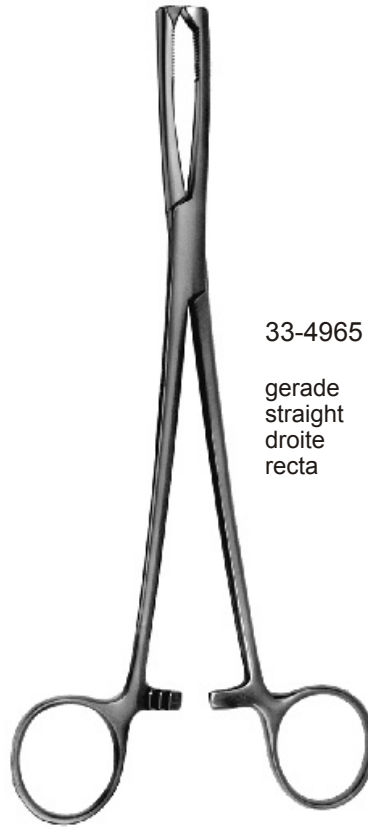

Jakobs
 21,0 cm/8¼"

33-4965
 gerade
 straight
 droite
 recta

33-4966
 aufgebogen
 curved on flat
 courbe sur le plat
 curva sobre el plano

33-4967
 seitwärts gebogen
 curved sideways
 courbe sur le côté
 curva lateral

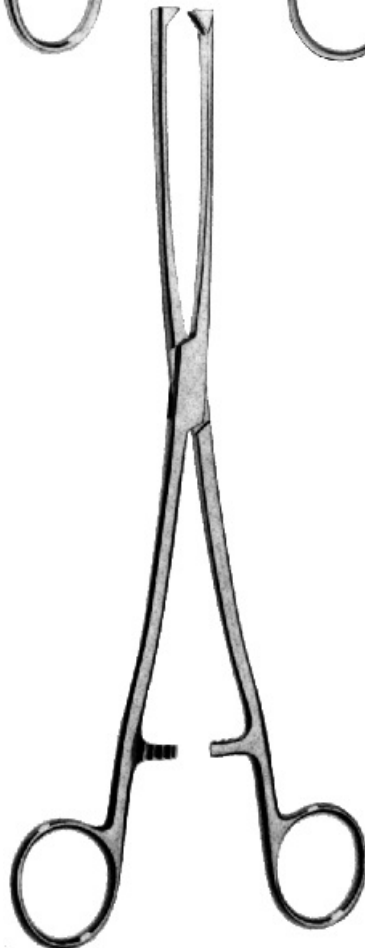

gerade
 straight
 droite
 recta

33-4970

6 mm



8 mm



33-4971

10 mm



33-4972

seitwärts gebogen
 curved sideways
 courbe sur le côté
 curva lateral

33-4973

33-4974

33-4975

Museux
 24,0 cm/9½"

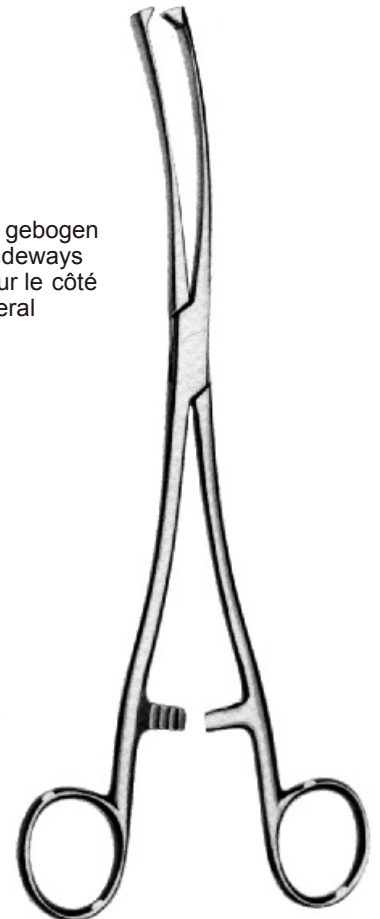

Uterus-Polypenzangen
Uterine Polypus Forceps
Pincés à polypes utérins
Pinzas para polipos uterinos

Uterus-Polypenzangen
Uterine Polypus Forceps
Pincés à polypes utérins
Pinzas para polipos uterinos



Noto

33-4989
27,0 cm/10½"

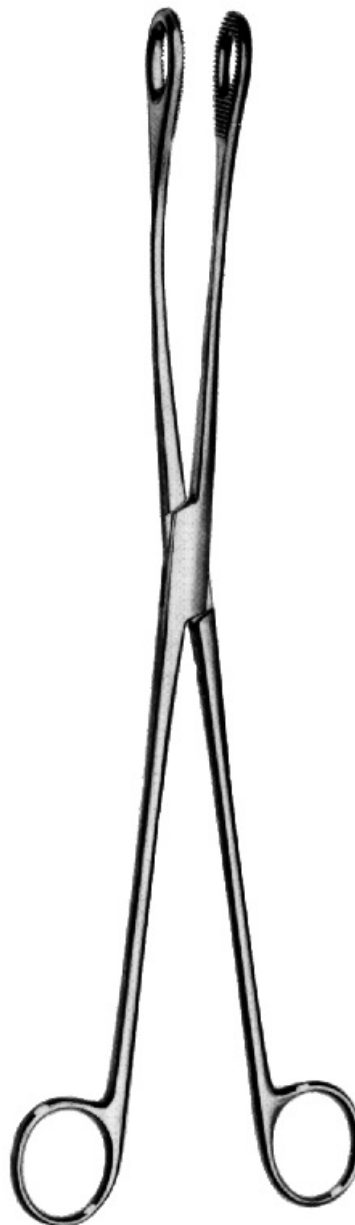

Kelly

33-4990
32,0 cm/12½"

Ovarien-Faßzange
Ovarian Elevating Forceps
Pincés pour les ovaires
Pinzas para ovarios



Doyen

33-4995
20,0 cm/8"

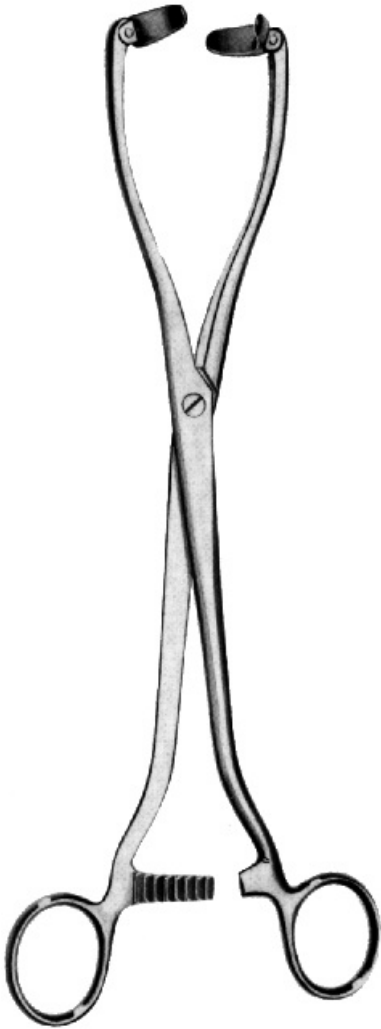

Collin

33-5000
25,0 cm/10"

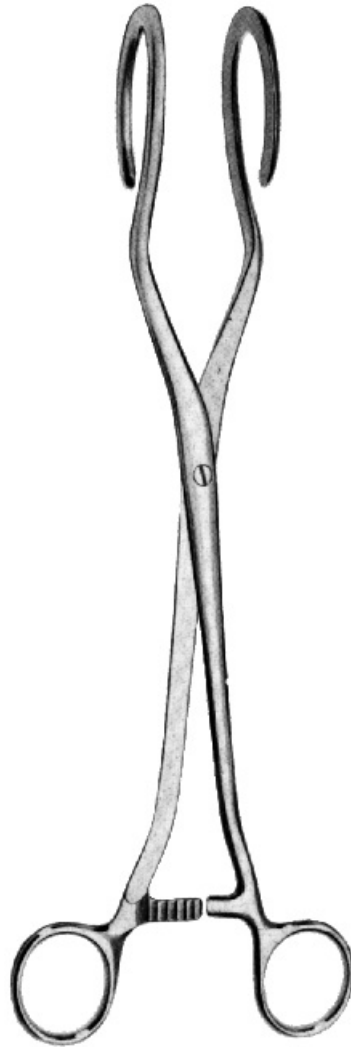

Dartigues

33-5001
27,0 cm/10½"



Sommer

33-5002
23,0 cm/9"

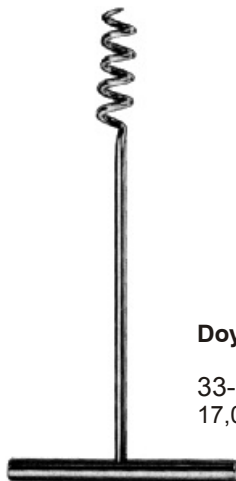

Doyen

33-5010-01
17,0 cm/6¾"

Myomheber
Myoma Screw
Tracteur de fibrome
Tiramiomas

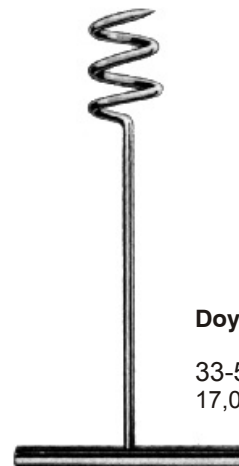

Doyen

33-5010-02
17,0 cm/6¾"



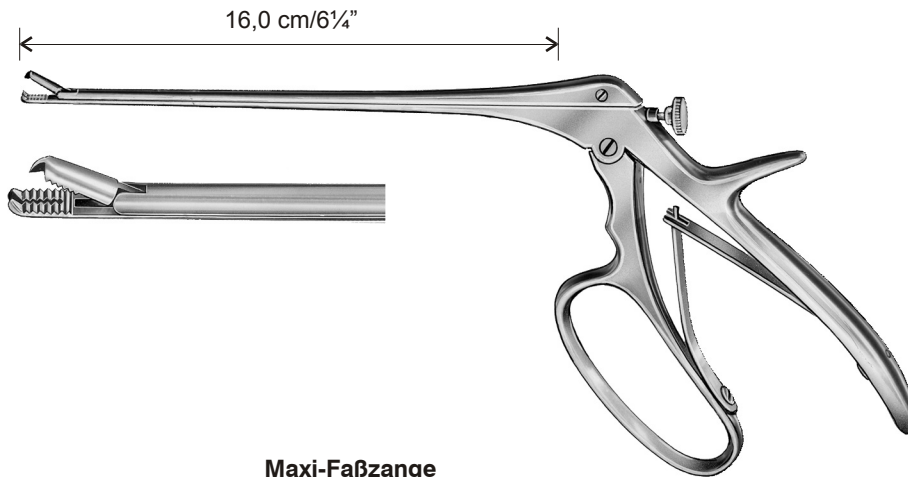

Maxi-Faßzange
Maxi Grasper
Maxi pince pour saisir
Maxi pinza para coger

33-5015

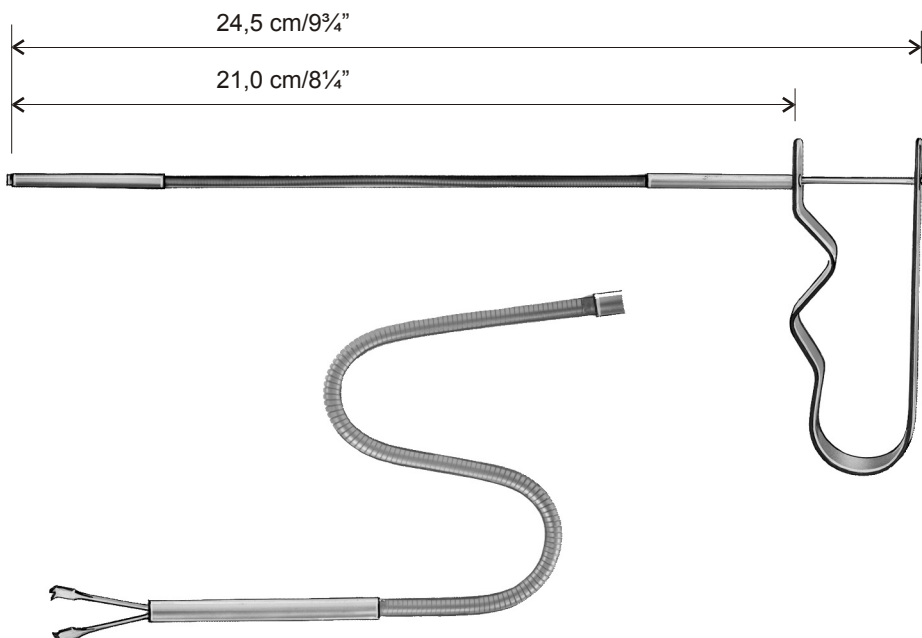

Flexible IUD Faßzange
Serpentine Grasper flexible IUD
Pince flexible IUD
Pinza flexible D.I.U

33-5018

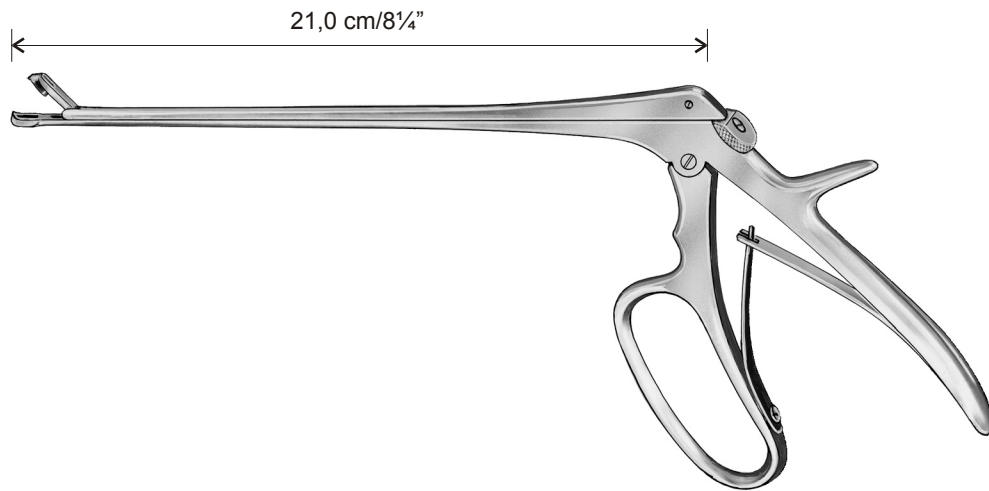

 3 x 9 mm

Tischler-Kevorkian

33-5020



 3 x 7 mm

Tischler

33-5021



 2,3 x 4 mm

Baby-Tischler

33-5022



 2,3 x 4 mm

Mini-Tischler

33-5023



 3 x 9 mm

Kevorkian

33-5024

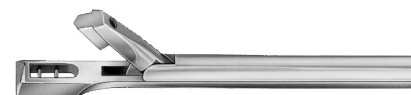

 3 x 7 mm

Coppelson

33-5025



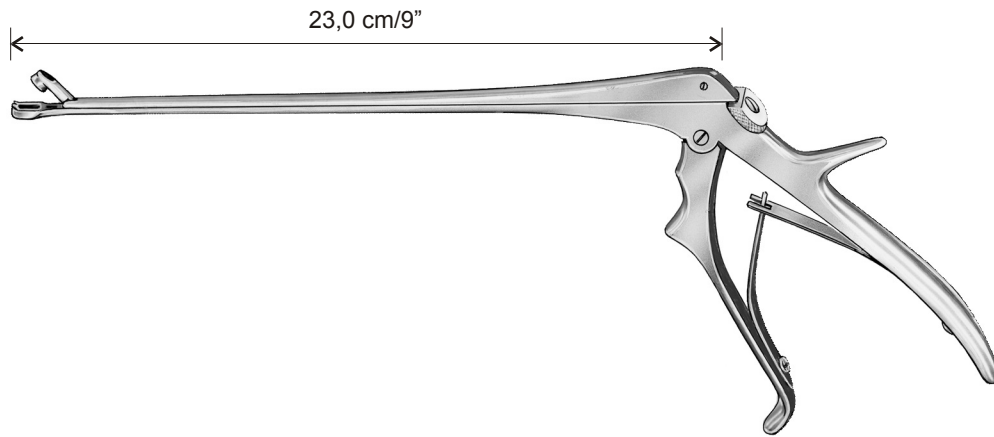

○ 3 x 5 mm

Burke

33-5026



○ 4 x 6,5 mm

Baggish

33-5027
gezahnt
toothed
dentelée
dentada

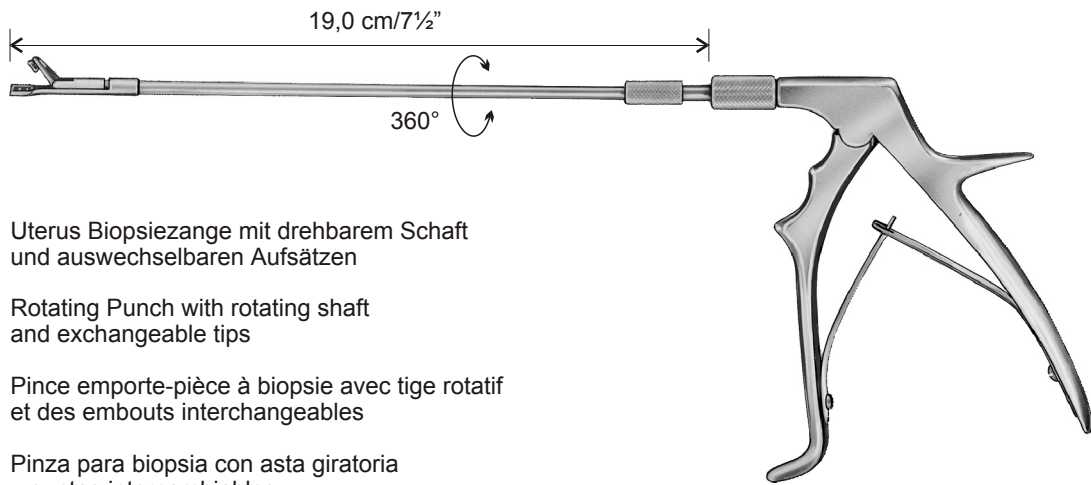

Uterus Biopsiezange mit drehbarem Schaft und auswechselbaren Aufsätzen

Rotating Punch with rotating shaft and exchangeable tips

Pince emporte-pièce à biopsie avec tige rotatif et des embouts interchangeables

Pinza para biopsia con asta giratoria y puntas intercambiables



○ 3 x 7 mm

Uni-Tischler

gerade
straight
droite
recta

33-5028-01
komplett, complete
complet, completo



○ 3 x 7 mm

Uni-Tischler

abwärts gebogen
downwards curved
courbe vers le bas
curva hacia abajo

33-5028-02
komplett, complete
complet, completo



○ 3 x 7 mm

Uni-Tischler

aufwärts gebogen
upwards curved
courbe vers le haut
curva hacia arriba

33-5028-03
komplett, complete
complet, completo



□ 2,3 x 4 mm

Uni-Townsend

gerade
straight
droite
recta

33-5029-01
komplett, complete
complet, completo



□ 2,3 x 4 mm

Uni-Townsend

abwärts gebogen
downwards curved
courbe vers le bas
curva hacia abajo

33-5029-02
komplett, complete
complet, completo



□ 2,3 x 4 mm

Uni-Townsend

aufwärts gebogen
upwards curved
courbe vers le haut
curva hacia arriba

33-5029-03
komplett, complete
complet, completo



○ 3 x 5 mm

Uni-Oval

33-5030
komplett, complete
complet, completo



□ 3 x 9 mm

Uni-Kevorkian

33-5031
komplett, complete
complet, completo



○ 3 x 4 mm

Uni-Burke

33-5032
komplett, complete
complet, completo



△ 3,8 x 6 mm

Schuhmacher

33-5032-38
komplett, complete
complet, completo



Uni-Griff mit Ring
Handle with ring
Manche avec anneau
Mango con anillo
33-5033



Uni-Griff
Handle
Manche
Mango
33-5034



○ 3 x 7 mm

Uni-Tischler gerade
straight
33-5035-01 droite
Aufsatz allein mit Rohr recta
Tip only with tube
Embout seul avec tubes-rallonge
Punta sola con tubo de extensión



○ 3 x 7 mm

Uni-Tischler abwärts gebogen
downwards curved
33-5035-02 courbe vers le bas
Aufsatz allein mit Rohr curva hacia abajo
Tip only with tube
Embout seul avec tubes-rallonge
Punta sola con tubo de extensión



○ 3 x 7 mm

Uni-Tischler aufwärts gebogen
upwards curved
33-5035-03 courbe vers le haut
Aufsatz allein mit Rohr curva hacia arriba
Tip only with tube
Embout seul avec tubes-rallonge
Punta sola con tubo de extensión



□ 2,3 x 4 mm

Uni-Townsend gerade
straight
33-5036-01 droite
Aufsatz allein mit Rohr recta
Tip only with tube
Embout seul avec tubes-rallonge
Punta sola con tubo de extensión



□ 2,3 x 4 mm

Uni-Townsend abwärts gebogen
downwards curved
33-5036-02 courbe vers le bas
Aufsatz allein mit Rohr curva hacia abajo
Tip only with tube
Embout seul avec tubes-rallonge
Punta sola con tubo de extensión



□ 2,3 x 4 mm

Uni-Townsend aufwärts gebogen
upwards curved
33-5036-03 courbe vers le haut
Aufsatz allein mit Rohr curva hacia arriba
Tip only with tube
Embout seul avec tubes-rallonge
Punta sola con tubo de extensión



○ 3 x 5 mm

Uni-Oval
33-5037
Aufsatz allein mit Rohr
Tip only with tube
Embout seul avec tubes-rallonge
Punta sola con tubo de extensión



□ 3 x 9 mm

Uni-Kevorkian
33-5038
Aufsatz allein mit Rohr
Tip only with tube
Embout seul avec tubes-rallonge
Punta sola con tubo de extensión



○ 3 x 4 mm

Uni-Burke
33-5039
Aufsatz allein mit Rohr
Tip only with tube
Embout seul avec tubes-rallonge
Punta sola con tubo de extensión



◁ 3,8 x 6 mm

Schuhmacher
33-5039-38

Aufsatz allein mit Rohr
Tip only with tube
Embout seul avec tubes-rallonge
Punta sola con tubo de extensión

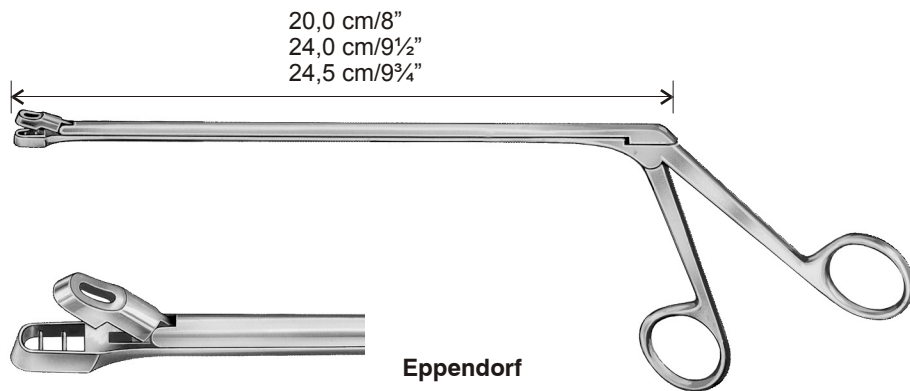

4,5 x 8 mm

Eppendorf

33-5040
20,0 cm/8"



4,5 x 8 mm

Wittner

33-5041
20,0 cm/8"
gebogen, curved
courbe, curva

Wittner

33-5042
20,0 cm/8"
gerade, straight
droite, recta



4 mm = Fig. 1

6 mm = Fig. 2

Schumacher

Fig. 1
33-5043
24,0 cm/9 1/2"

Schumacher

Fig. 2
33-5044
24,0 cm/9 1/2"



3 x 9 mm

Kevorkian

33-5049
24,5 cm/9 1/2"



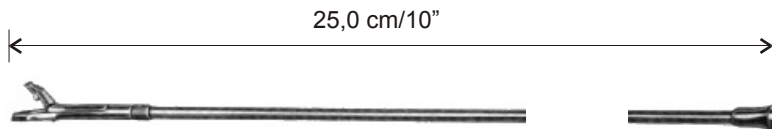

Schuhmacher

33-5047
komplett, complete
complet, completo



4 mm

Schuhmacher

33-5048
Aufsatz allein
Tip only
Embout seul
Punta sola

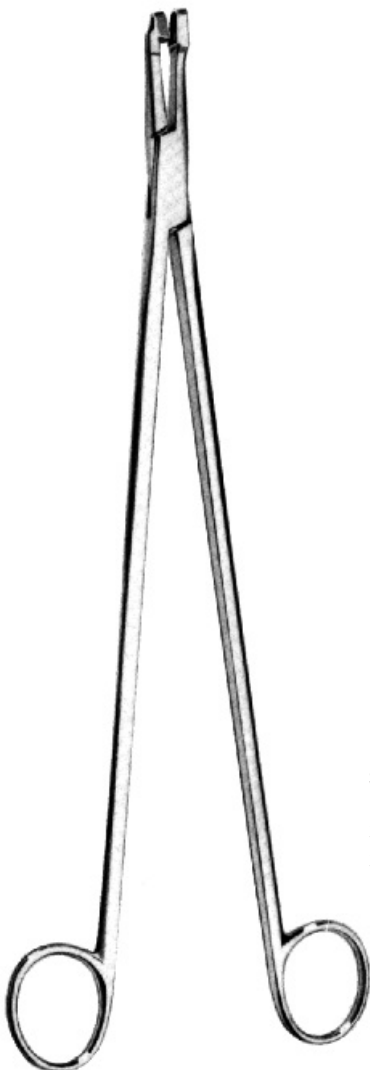

Schubert

33-5051 21,0 cm/8¼"
33-5052 29,0 cm/11½"

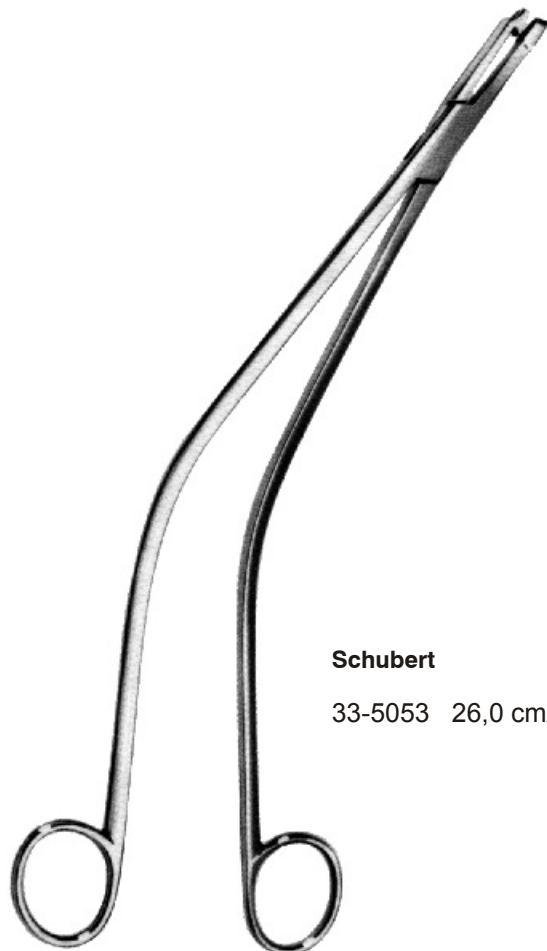

Schubert

33-5053 26,0 cm/10¼"





Tischler

33-5054
27,0 cm/10½"

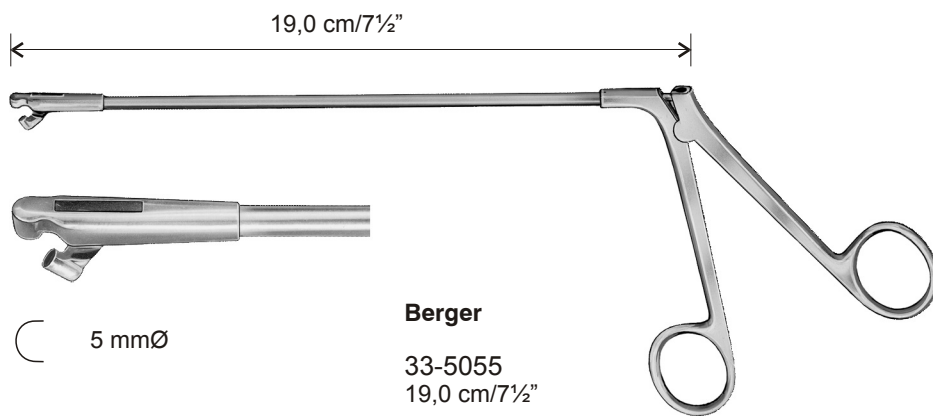

Berger

33-5055
19,0 cm/7½"



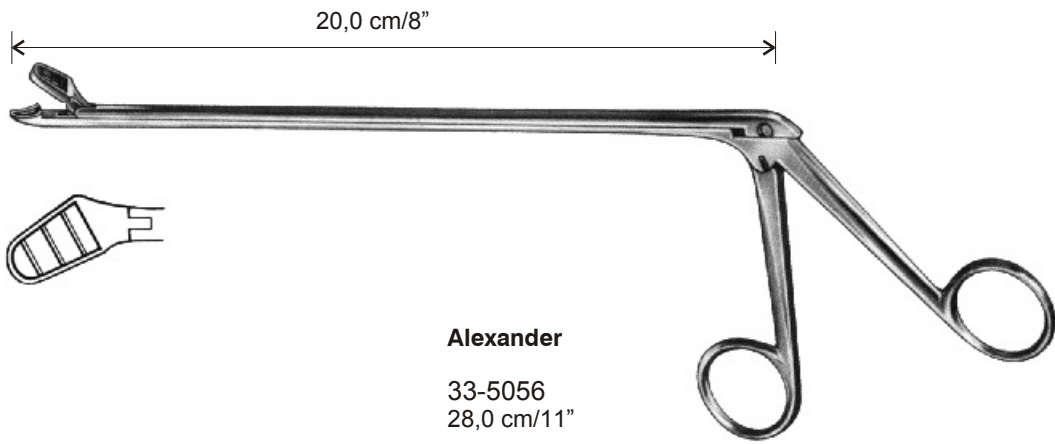

Alexander

33-5056
28,0 cm/11"

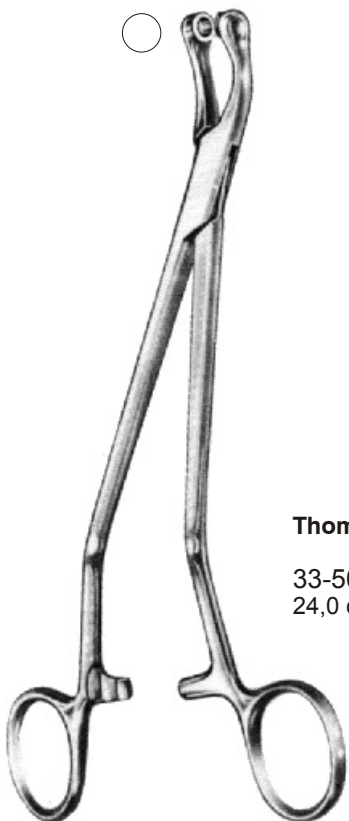

Thoms-Gaylor

33-5057
24,0 cm/9½"



33-5058
eckig
angular
angulaire
angular



33-5059
rund
round
ronde
redonda



Novak

23 cm/9"

- Fig. 1 1 mm = 33-5060-01
- Fig. 2 2 mm = 33-5060-02
- Fig. 3 3 mm = 33-5060-03
- Fig. 4 4 mm = 33-5060-04



Ø 4 mm

Randall

33-5061
 24 cm/9½"

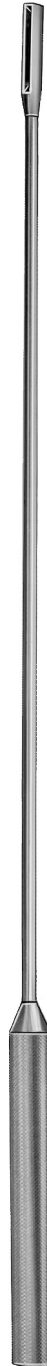

Ø 4,5 mm

Rotokürette
 Rotating curette
 Curette à rotation
 Cureta rotatoria

arbeitet drehend
 works rotating
 fonctionne avec rotation
 trabaja rotatoria

Rotokürette

33-5062
 30 cm/11¾"



1 mm

schmal
 narrow
 étroite
 estrecha

Kevorkian

33-5063
 30 cm/11¾"





Kevorkian

33-5064
2,5 mm
ohne Korb, eckig
without basket, angular
sans panier, angulaire
sin cesta, angular



Kevorkian

33-5065
2,2 mm
mit Korb, rund
with basket, round
avec panier, ronde
con cesta, redonda



Kevorkian-Young

33-5066
2,5 mm
mit Korb, eckig
with basket, angular
avec panier, angulaire
con cesta, angular

Kevorkian
30,0 cm/11³/₄"



4 mm

Luer-Lock

Novak-Schoeckaert

33-5067
24,0 cm/9¹/₂"



4 mm

Mod. Muenchen

33-5068
27,0 cm/10¹/₂"



10 mm 11 mm 12 mm 13 mm 14 mm 15 mm



1 2 3 4 5 6

Thomas
28,0 cm/11"

stumpf, biegsam, glatt
blunt, malleable, smooth
mousse, malléable, lisse
roma, maleable, lisa

- Fig. 1 33-5071
- Fig. 2 33-5072
- Fig. 3 33-5073
- Fig. 4 33-5074
- Fig. 5 33-5075
- Fig. 6 33-5076



7,5 mm 8,5 mm 10 mm 11,5 mm 13,5 mm 14,5 mm



1 2 3 4 5 6

Sims
25,0 cm/10"

scharf, biegsam sharp, malleable tranchante, malléable cortante, maleable	scharf, fest sharp, rigid tranchante, rigide cortante, rigida	stumpf, biegsam blunt, malleable mousse, malléable roma, maleable	stumpf, fest blunt, rigid mousse, rigide roma, rigida
--	--	--	--

Fig. 1	33-5081	33-5091	33-5101	33-5111
Fig. 2	33-5082	33-5092	33-5102	33-5112
Fig. 3	33-5083	33-5093	33-5103	33-5113
Fig. 4	33-5084	33-5094	33-5104	33-5114
Fig. 5	33-5085	33-5095	33-5105	33-5115
Fig. 6	33-5086	33-5096	33-5106	33-5116



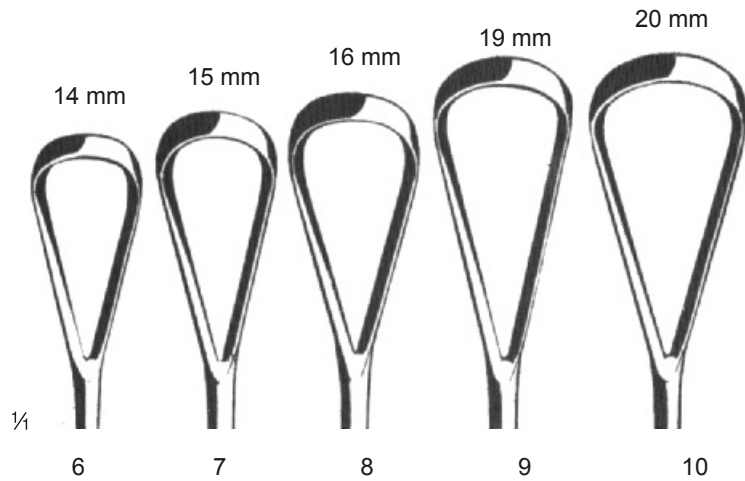
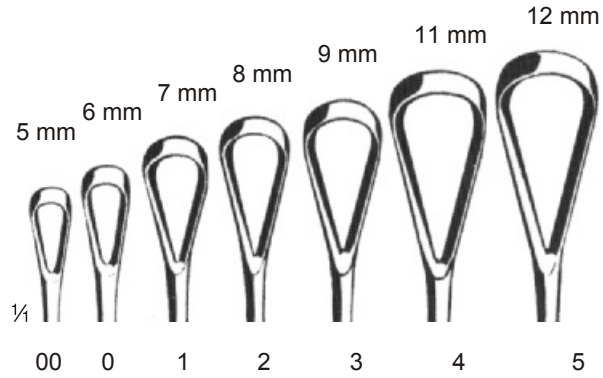

Recamier
31,0 cm/12 1/4"

	mm	scharf, biegsam sharp, malleable tranchante, malléable cortante, maleable	scharf, fest sharp, rigid tranchante, rigide cortante, rigida	stumpf, biegsam blunt, malleable mousse, malléable roma, maleable	stumpf, fest blunt, rigid mousse, rigide roma, rigida
Fig. 00	5	33-5120-20	33-5130-20	33-5140-20	33-5150-20
Fig. 0	6	33-5120-00	33-5130-00	33-5140-00	33-5150-00
Fig. 1	7	33-5120-01	33-5130-01	33-5140-01	33-5150-01
Fig. 2	8	33-5120-02	33-5130-02	33-5140-02	33-5150-02
Fig. 3	9	33-5120-03	33-5130-03	33-5140-03	33-5150-03
Fig. 4	11	33-5120-04	33-5130-04	33-5140-04	33-5150-04
Fig. 5	12	33-5120-05	33-5130-05	33-5140-05	33-5150-05
Fig. 6	14	33-5120-06	33-5130-06	33-5140-06	33-5150-06
Fig. 7	15	33-5120-07	33-5130-07	33-5140-07	33-5150-07
Fig. 8	16	33-5120-08	33-5130-08	33-5140-08	33-5150-08
Fig. 9	19	33-5120-09	33-5130-09	33-5140-09	33-5150-09
Fig. 10	20	33-5120-10	33-5130-10	33-5140-10	33-5150-10
Fig. 11	21	33-5120-11	33-5130-11	33-5140-11	33-5150-11
Fig. 12	23	33-5120-12	33-5130-12	33-5140-12	33-5150-12
Fig. 13	25	33-5120-13	33-5130-13	33-5140-13	33-5150-13
Fig. 14	30	33-5120-14	33-5130-14	33-5140-14	33-5150-14
Fig. 15	35	33-5120-15	33-5130-15	33-5140-15	33-5150-15
Fig. 16	40	33-5120-16	33-5130-16	33-5140-16	33-5150-16

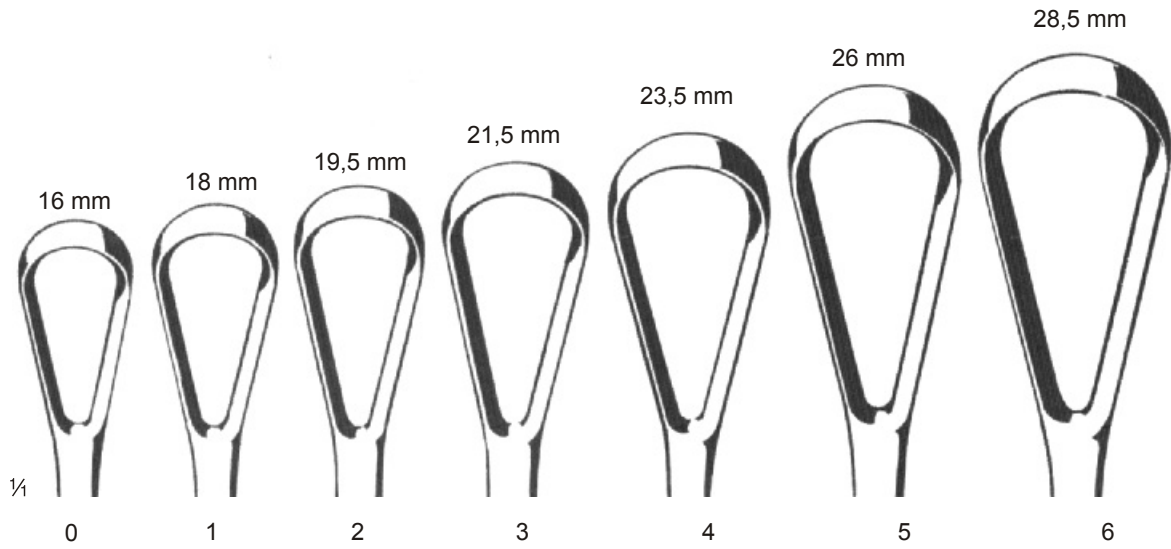

Bumm
28,0 cm/11"

	scharf, biegsam sharp, malleable tranchante, malléable cortante, maleable	stumpf, biegsam blunt, malleable mousse, malléable roma, maleable
Fig. 0	33-5160	33-5170
Fig. 1	33-5161	33-5171
Fig. 2	33-5162	33-5172
Fig. 3	33-5163	33-5173
Fig. 4	33-5164	33-5174
Fig. 5	33-5165	33-5175
Fig. 6	33-5166	33-5176



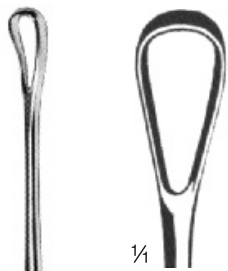

doppelt, scharf-stumpf
 double, sharp-blunt
 double, tranchante-mousse
 doble, cortante-roma



Blake

33-5180
 27,0 cm/10½"

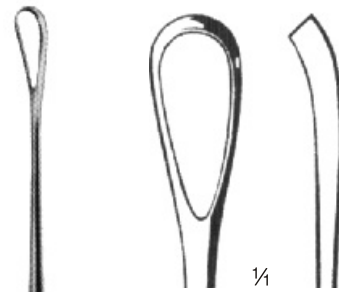

doppelt, scharf-stumpf
 double, sharp-blunt
 double, tranchante-mousse
 doble, cortante-roma



Zweifel

33-5181
 31,0 cm/12¼"





Fig. 1
33-5190-01



Fig. 2
33-5190-02



Fig. 3
33-5190-03



Fig. 4
33-5190-04



Fig. 5
33-5190-05



Fig. 6
33-5190-06



1/2

Simon
25,0 cm/10"

scharf, fest
sharp, rigid
tranchante, rigide
cortante, rigida



Fig. 1
33-5191-01



Fig. 2
33-5191-02



Fig. 3
33-5191-03



Fig. 4
33-5191-04



Fig. 5
33-5191-05



Fig. 6
33-5191-06



1/2

Schroeder
30,0 cm/12"

scharf, fest
sharp, rigid
tranchante, rigide
cortante, rigida



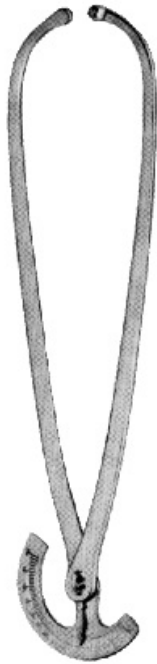

Collin
 33-5301
 35,0 cm/13¾"



Martin
 33-5302
 34,0 cm/13½"



Naegele
 33-5310 36,0 cm/14"
 33-5311 40,0 cm/16"



Simpson-Braun
 33-5318 30,0 cm/12"
 33-5320 33,0 cm/13"
 33-5321 36,0 cm/14"



Simpson-Luikart
 33-5323 36,0 cm/14"



Kielland

33-5325 41,0 cm/16"



Kielland-Luikart

33-5327 40,0 cm/15¾"



Piper

33-5330 44,0 cm/17¼"



Elliot

33-5333 38,0 cm/15"

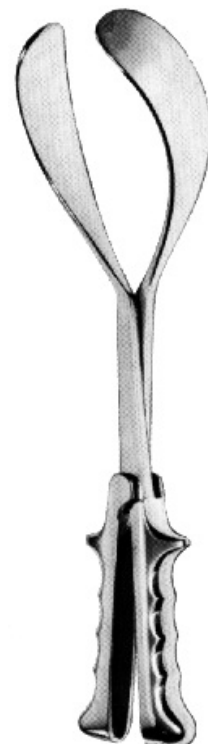

Mc Lean-Tucker

33-5338 39,0 cm/15½"



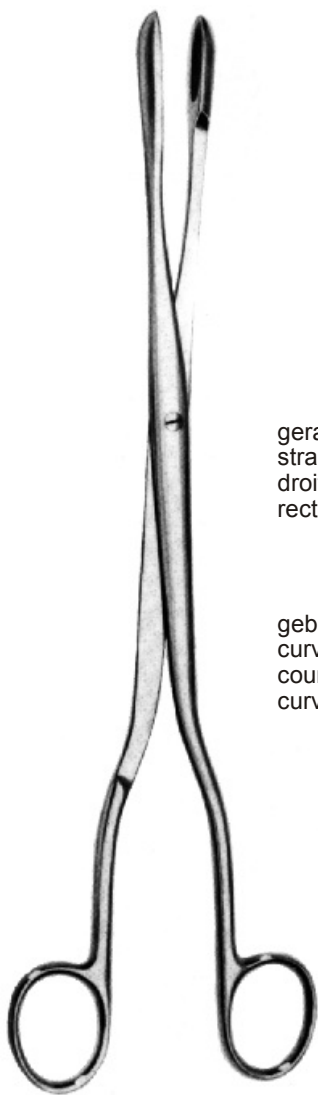

Winter
28,0 cm/11"



33-5380



33-5381



33-5382

gerade
straight
droite
recta

33-5385

33-5386

33-5387

gebogen
curved
courbe
curva

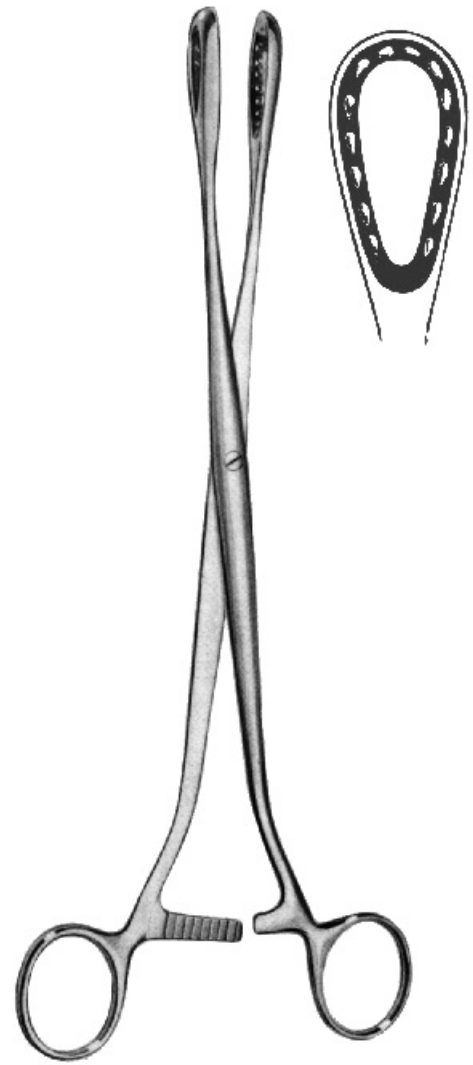

33-5390

gerade
straight
droite
recta

Saenger
27,0 cm/10½"

33-5391

gebogen
curved
courbe
curva

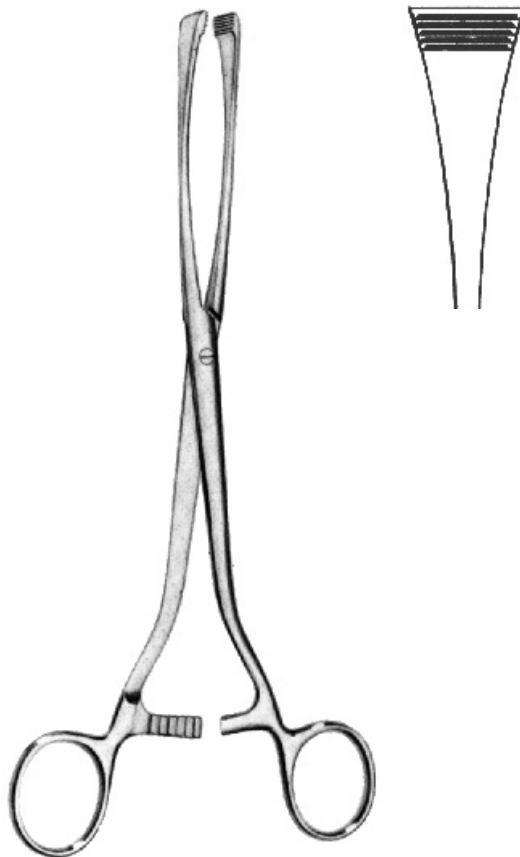

Green-Armytage

33-5395
21,0 cm/8¼"



**HNO-Instrumente
ENT-Instruments
Instruments ORL
Instrumental ORL**



3 4

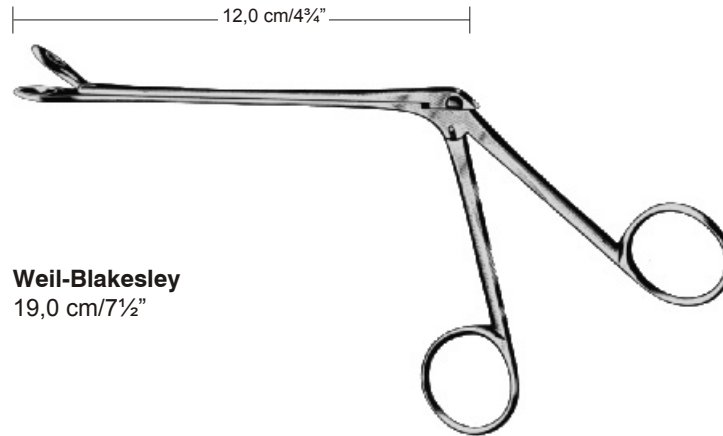

Weil-Blakesley
19,0 cm / 7 1/2"



gerade straight droite recta	Standard	mit Absaugrohr with suction tube avec tube d'aspiration con tubo de aspiración
2,5 mm	34-5401	34-5421
3,6 mm	34-5402	34-5422
4,8 mm	34-5403	34-5423
5,3 mm	34-5404	34-5424
6,3 mm	34-5405	34-5425

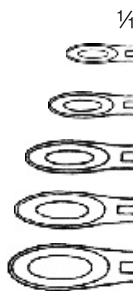

45° aufgebogen 45° curved upwards 45° courbe en haut 45° curva arriba	Standard	mit Absaugrohr with suction tube avec tube d'aspiration con tubo de aspiración
2,5 mm	34-5406	34-5426
3,6 mm	34-5407	34-5427
4,8 mm	34-5408	34-5428
5,3 mm	34-5409	34-5429
6,3 mm	34-5410	34-5430

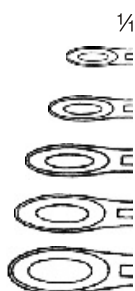

90° aufgebogen 90° curved upwards 90° courbe en haut 90° curva arriba	Standard	mit Absaugrohr with suction tube avec tube d'aspiration con tubo de aspiración
2,5 mm	34-5411	34-5431
3,6 mm	34-5412	34-5432
4,8 mm	34-5413	34-5433
5,3 mm	34-5414	34-5434
6,3 mm	34-5415	34-5435



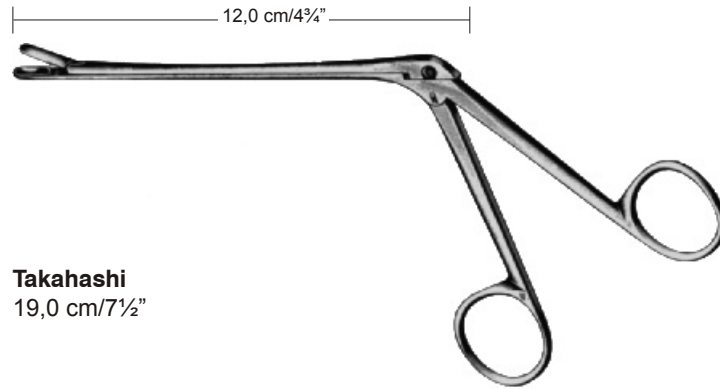

Takahashi
19,0 cm / 7 1/2"



	gerade straight droite recta	Standard	mit Absaugrohr with suction tube avec tube d'aspiration con tubo de aspiración
Fig. 1	2,5 mm	34-5416	34-5436
Fig. 2	4,0 mm	34-5417	34-5437

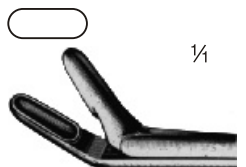

	45° aufgebogen 45° curved upwards 45° courbe en haut 45° curva arriba	Standard	mit Absaugrohr with suction tube avec tube d'aspiration con tubo de aspiración
Fig. 1	2,5 mm	34-5418	34-5438
Fig. 2	4,0 mm	34-5419	34-5439

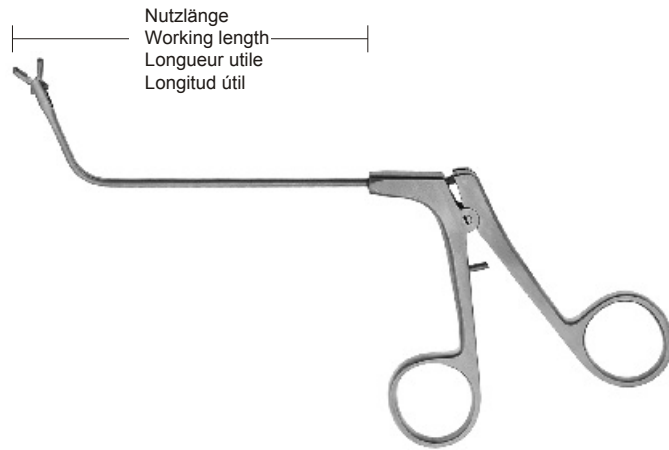

¼

34-5440
 gerade
 straight
 droite
 recta

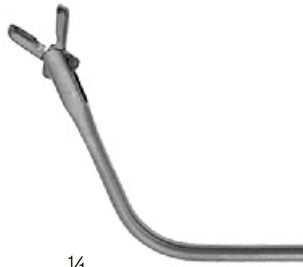

¼

34-5441
 70° aufgebogen
 70° curved upwards
 70° courbe en haut
 70° curva arriba



¼

34-5442
 110° aufgebogen
 110° curved upwards
 110° courbe en haut
 110° curva arriba



	Maul Jaw Mors Boca	Nutzlänge Working length Longueur utile Longitud útil
34-5440	3 x 4,5 mm	110 mm
34-5441	3 x 4,5 mm	80 mm
34-5442	3 x 4,5 mm	70 mm

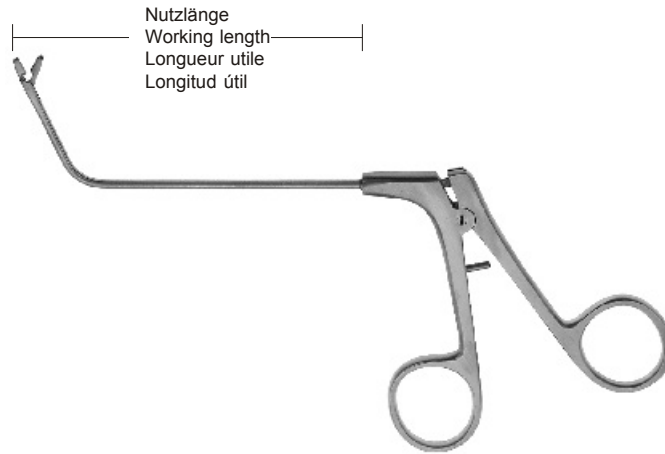

34-5445
gerade
straight
droite
recta

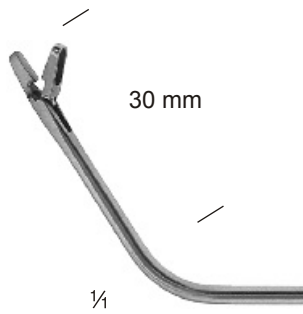

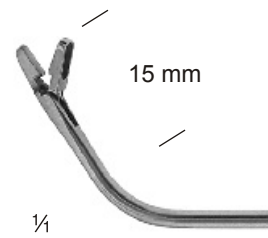

34-5446
70° aufgebogen
70° curved upwards
70° courbe en haut
70° curva arriba

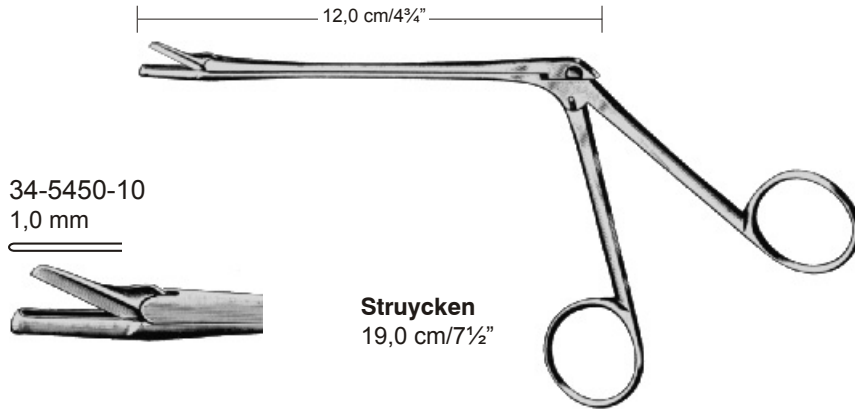

34-5447
70° aufgebogen
70° curved upwards
70° courbe en haut
70° curva arriba

	Maul Jaw Mors Boca	Nutzlänge Working length Longueur utile Longitud útil
34-5445	1,5 x 5 mm	110 mm
34-5446	1,5 x 5 mm	80 mm
34-5447	1,5 x 5 mm	80 mm

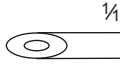

	Bißbreite Width of bite Grandeur de coupe Ancho de la boca	Schaftlänge, Length of shaft Longueur de tige, Largo del asta		Schaftlänge, Length of shaft Longueur de tige, Largo del asta	
		13,0 cm / 5"	17,0 cm / 6 1/4"	13,0 cm / 5"	17,0 cm / 6 1/4"
	3 x 8 mm	34-5452-13	34-5452-17	34-5455-13	34-5455-17
	4 x 10 mm	34-5453-13	34-5453-17	34-5456-13	34-5456-17
	5 x 12 mm	34-5454-13	34-5454-17	34-5457-13	34-5457-17

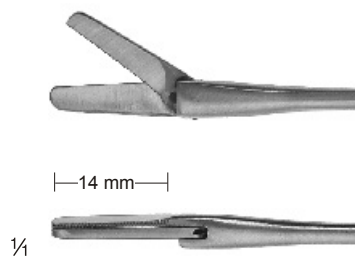
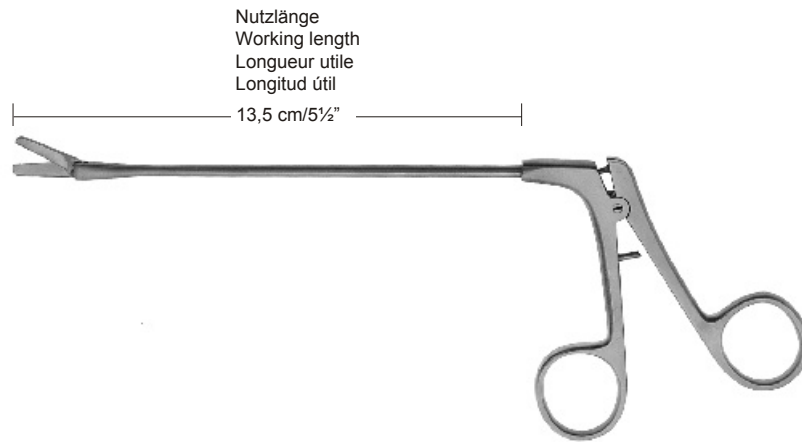

34-5460
gerade
straight
droite
recta

1 Schneide gezahnt
1 Blade toothed
1 Tranchant dentelé
1 Filo dentado

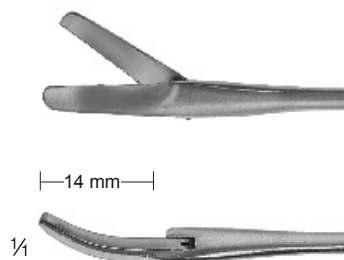

34-5461
nach rechts gebogen
curved to the right
courbe à droite
curva hacia la derecha

1 Schneide gezahnt
1 Blade toothed
1 Tranchant dentelé
1 Filo dentado

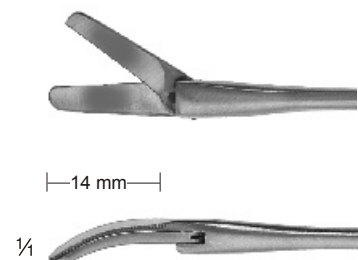

34-5462
nach links gebogen
curved to the left
courbe à gauche
curva hacia la izquierda

1 Schneide gezahnt
1 Blade toothed
1 Tranchant dentelé
1 Filo dentado



gezahnt
toothed
dentelés
dentadas



Caplan

34-5470
20,0 cm/8"

gezahnt
toothed
dentelés
dentadas



Killian

34-5471
21,0 cm/8½"



Rubin

34-5472-01
21,0 cm/8½"

TC-Rubin

34-5472-02
21,0 cm/8½"

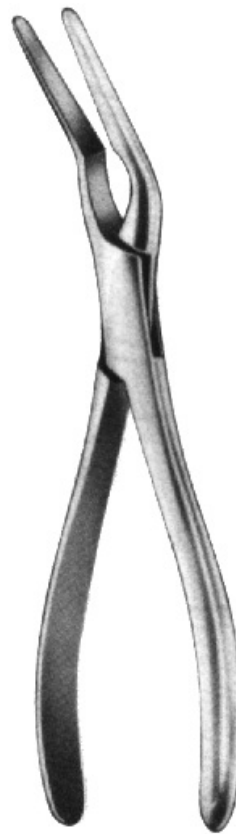

Asch

34-5473
22,0 cm/8¾"



34-5501

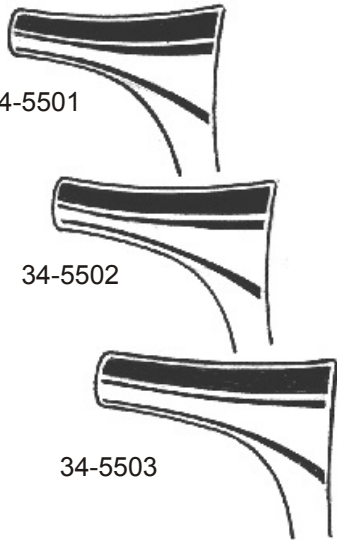

34-5502

34-5503

Hartmann
16,5 cm/6½"



34-5506

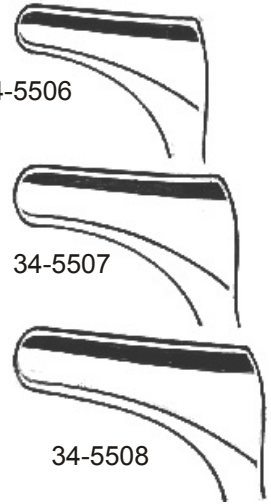

34-5507

34-5508

Hartmann-Halle
15,0 cm/6"



Tieck-Halle

34-5510
13,5 cm/5¼"



Tieck-Halle

34-5511
13,5 cm/5¼"



Cottle
 16,5 cm/6½"

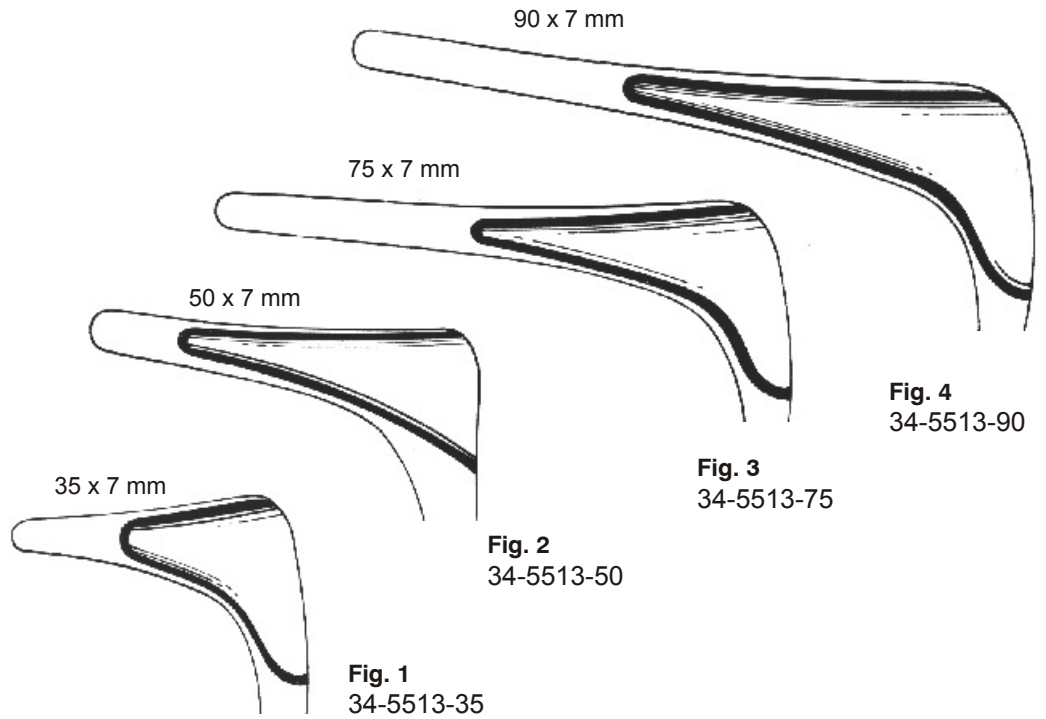

Fig. 1
 34-5513-35

Fig. 2
 34-5513-50

Fig. 3
 34-5513-75

Fig. 4
 34-5513-90



Cottle
 14,0 cm/5½"

Schwarz verchromt
 black chromium plated
 chromé en noir
 cromado en negro

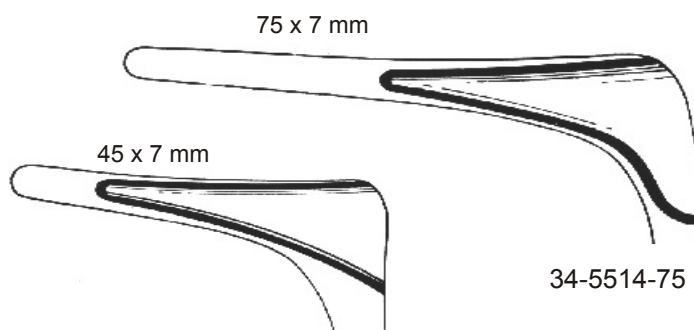

34-5514-45

34-5514-75





Killian
 13,0 cm/5"



34-5515
 35 mm

34-5516
 50 mm

34-5517
 75 mm

34-5518
 90 mm



Thudichum (Goldsmith)
 6,5 cm/2½"



Fig. 1
 34-5522-01

Fig. 2
 34-5522-02

Fig. 3
 34-5522-03

Fig. 4
 34-5522-04



Fig. 5
 34-5522-05

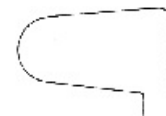

Fig. 6
 34-5522-06



Fig. 7
 34-5522-07





Krause

34-5530
26,0 cm/10¼"



Krause-Voss

34-5531
26,0 cm/10¼"

Stahldraht für Polypenschnürer
Steel wire for nasal snares
Anses en fil d'acier pour serre- nœuds
Alambre de acero para polipótomos



34-6018 0,3 mmØ

Pack à 12 Stück
Pack of 12 pieces
Paquet à 12 pièces
Paquete con 12 piezas



10 m / 33ft.

34-5532-30 0,3 mmØ
34-5532-40 0,4 mmØ



Hartmann

34-5549 13,0 cm/5"
34-5550 16,0 cm/6¼"



Hartmann

34-5551 20,0 cm/8"



Heymann-Knight

34-5552 18,0 cm/7"



Littauer

34-5553 18,0 cm/7"



Troeltsch (Wilde)

34-5554 11,0 cm/4½"
34-5555 12,0 cm/4¾"
34-5556 15,0 cm/6"
34-5557 18,0 cm/7"



Troeltsch (Wilde) 1 x 2

34-5559 12,0 cm/4¾"
34-5560 15,0 cm/6"



bajonettförmig
bayonet-shaped
en forme de baïonette
en forma de bayoneta

Jansen

34-5562 16,0 cm/6½"
34-5563 18,0 cm/7"

Grünwald-Jansen

34-5564 20,0 cm/8"



Lucae

34-5565 14,0 cm/5½"



Lucae 1 x 2

34-5566 14,0 cm/5½"



Cottle

34-5567 14,0 cm/5½"



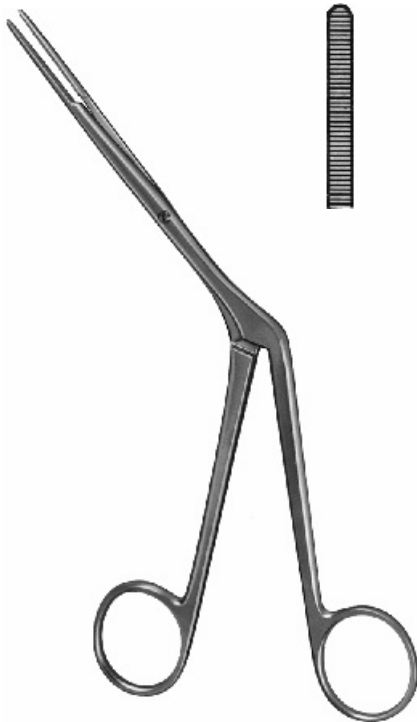

Westmacott

34-5568 20,0 cm/8"



Graig

34-5569 18,0 cm/7"

Nasen-Septumzange
Nasal Septum Forceps
Pinces pour la cloison nasale
Pinzas para el tabique nasal

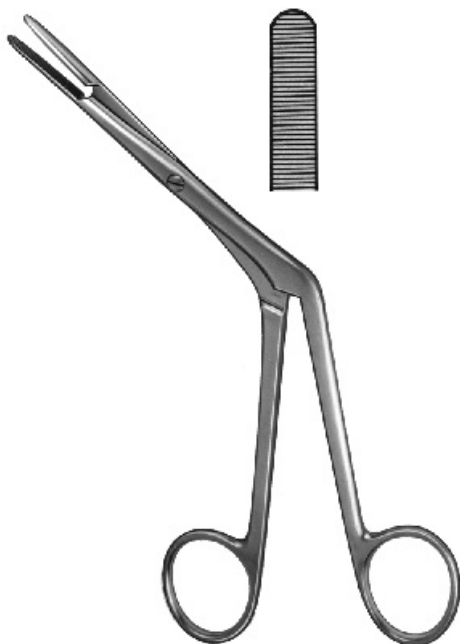

Killian

34-5570 17,0 cm/6³/₄"



Knight

34-5571-18 18,0 cm/7"

Septumzange
Septum Forzeps
Pince pour la cloison nasale
Pinza para el tabique nasal

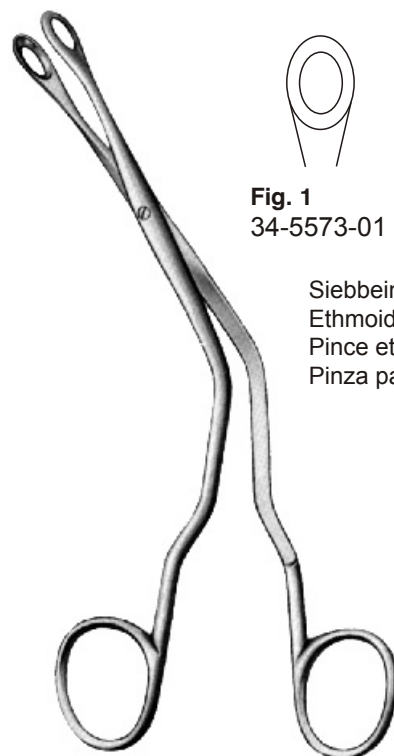

Luc

20,0 cm/8"

Fig. 1
34-5573-01

Fig. 2
34-5573-02

Siebbeinzange
Ethmoid Forceps
Pince ethmoidales
Pinza para etmoides





durchschneidend
through-cutting
coupantes des deux côtés
bocas cortantes la una en la otra

Middleton-Jansen

34-5574-01
19,0 cm/7½"



Löffelmaul
spoon-shaped jaw
mors en forme d'un cuiller
con boca en forma de cucharilla

Middleton-Jansen

34-5574-02
19,0 cm/7½"

4
3

..

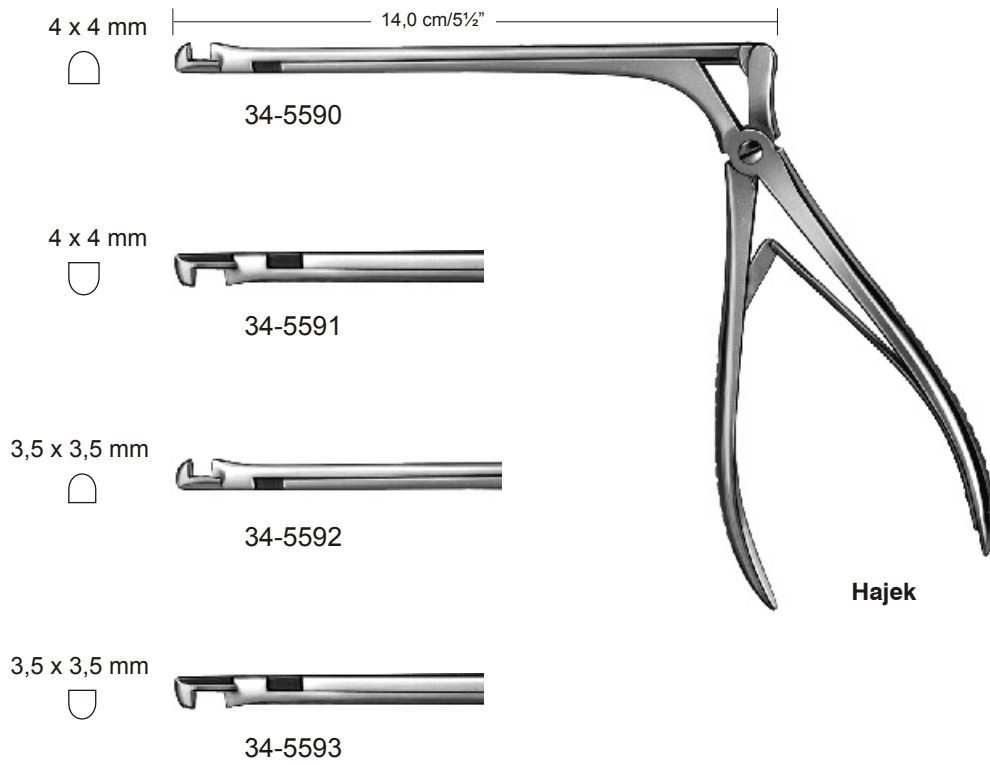

Kieferhöhlenstanze
Antrum Punch Forceps
Pincas emporte-pièces pour sinus maxillaire
Pinzas cortantes para seno maxilar

34-5596
4 mm



34-5597
5 mm

34-5598
6 mm

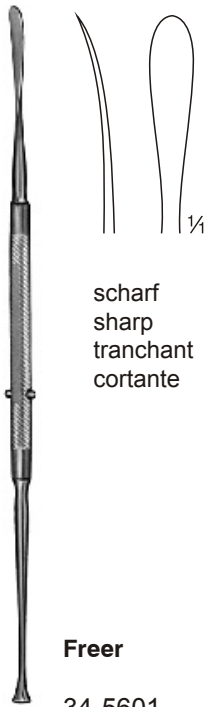

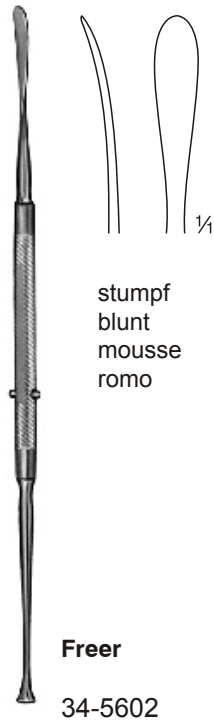

Freer
 34-5601



Freer
 34-5602

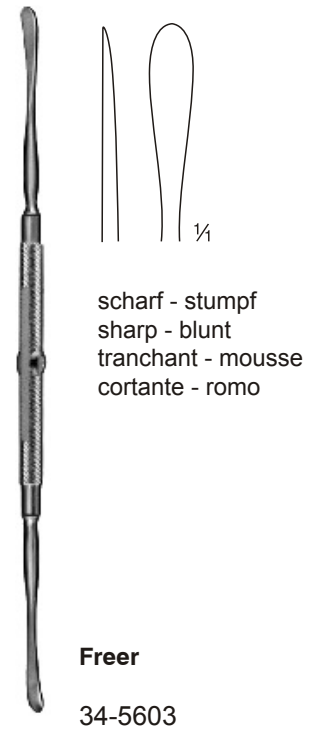

Freer
 34-5603

4
3

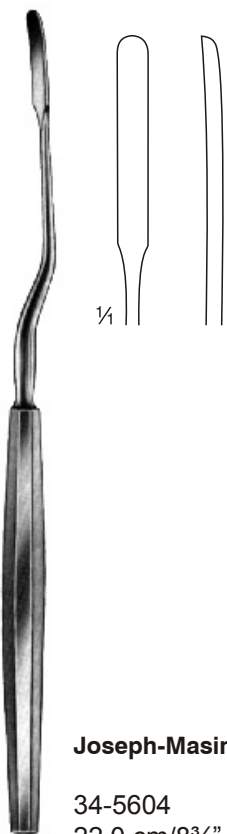

Joseph-Masing
 34-5604
 22,0 cm/8³/₄"

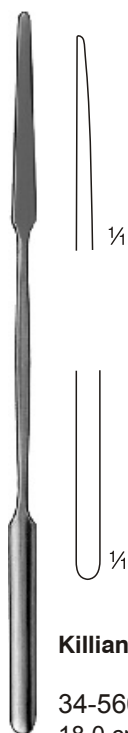

Killian
 34-5605
 18,0 cm/7"

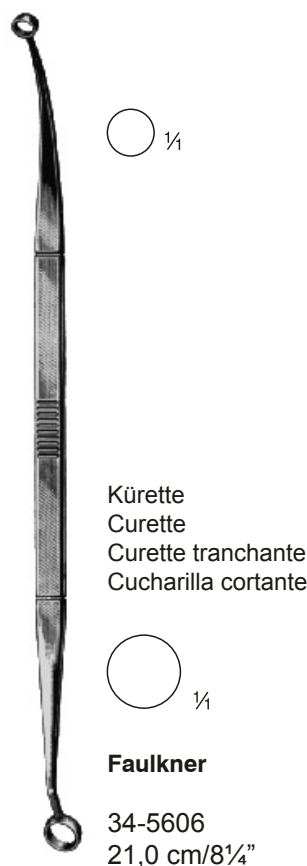

Kürette
 Curette
 Curette tranchante
 Cucharilla cortante

Faulkner
 34-5606
 21,0 cm/8¹/₄"

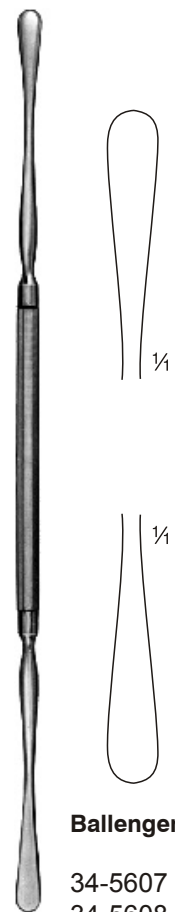

Ballenger-Hajek
 34-5607 19,0 cm/7¹/₂"
 34-5608 22,0 cm/8³/₄"

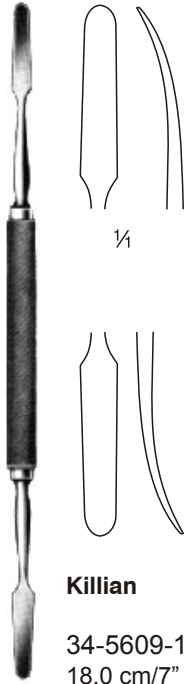

Killian

34-5609-18
18,0 cm/7"

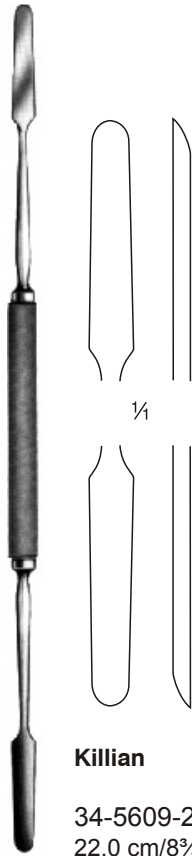

Killian

34-5609-22
22,0 cm/8³/₄"

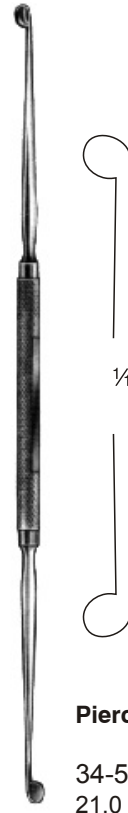

Pierce

34-5610
21,0 cm/8¹/₂"

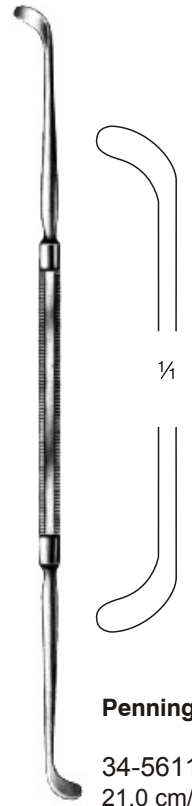

Pennington

34-5611
21,0 cm/8¹/₂"

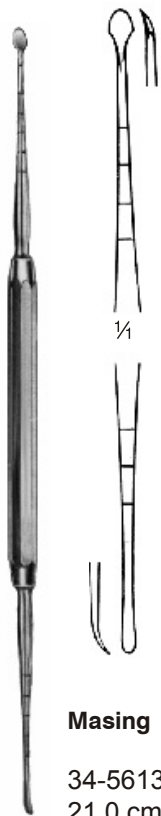

Masing

34-5613
21,0 cm/8¹/₂"

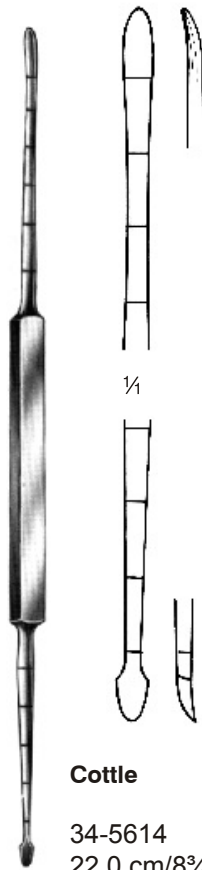

Cottle

34-5614
22,0 cm/8³/₄"

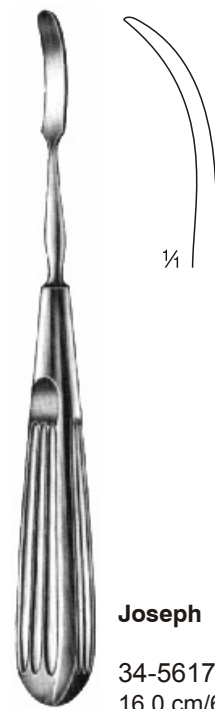

Joseph

34-5617
16,0 cm/6¹/₄"

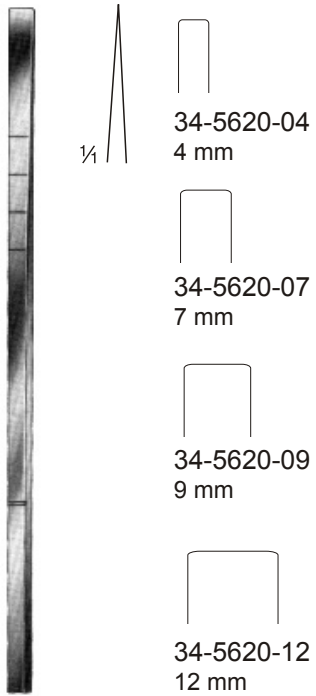

Cottle
18,0 cm/7"

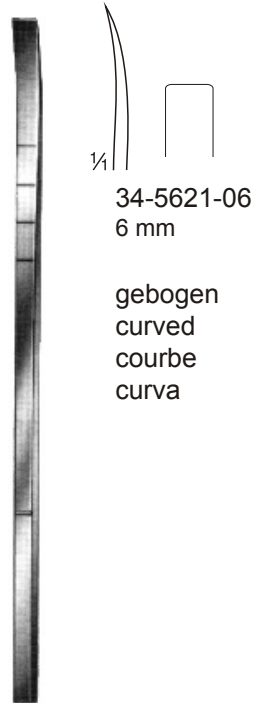

Cottle
18,0 cm/7"

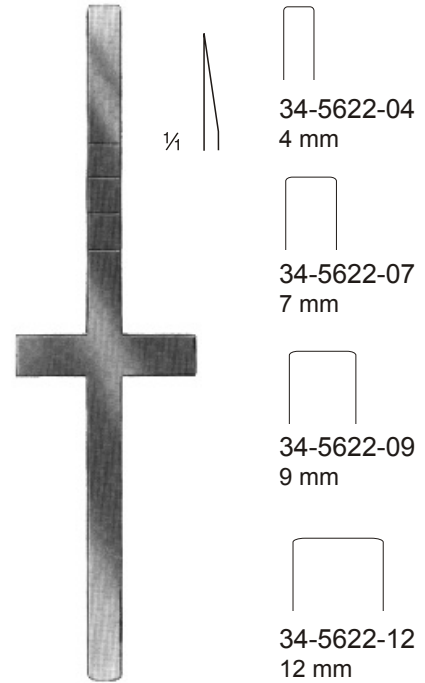

Cottle
18,0 cm/7"

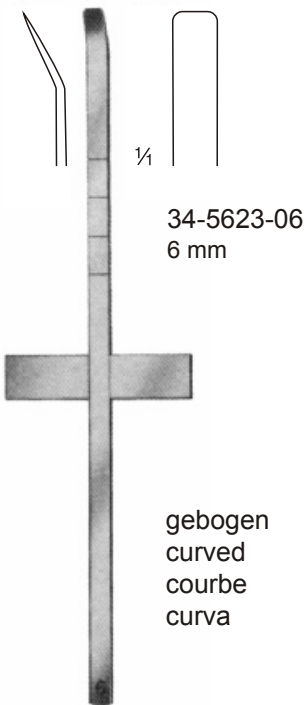

Cottle
18,0 cm/7"

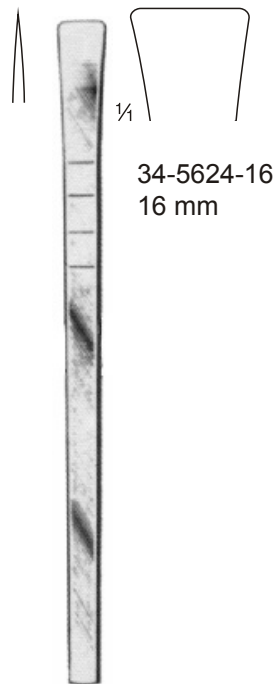

Cottle
18,0 cm/7"

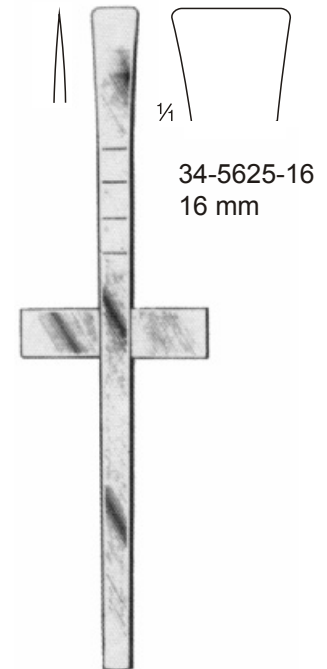

Cottle
18,0 cm/7"



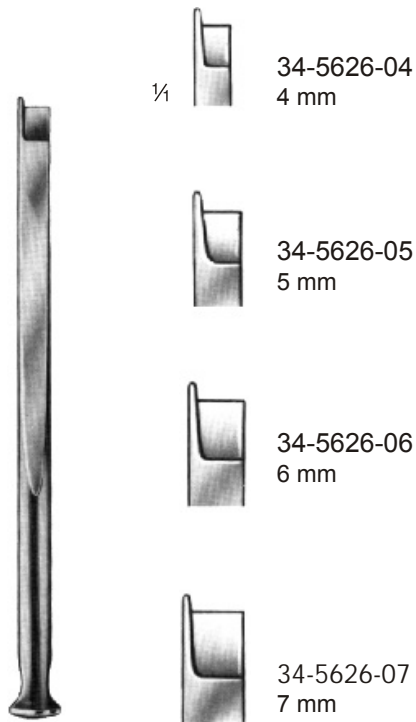

Fomon
17,0 cm/6¾"

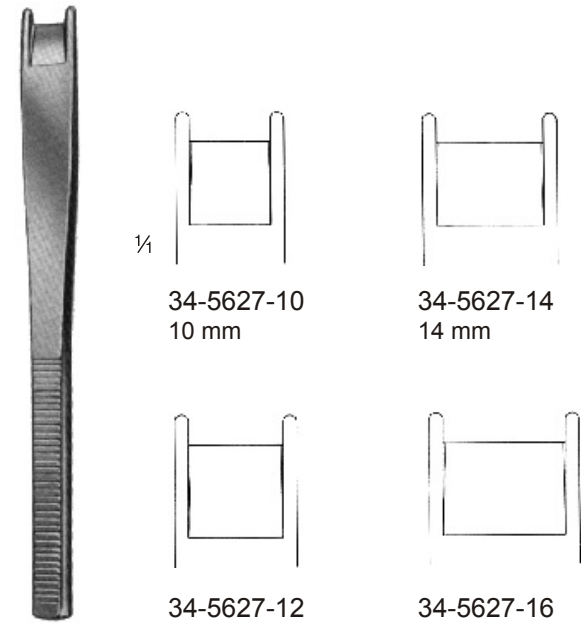

Cinelli
16,0 cm/6½"

Flachmeißel
Chisel
Ciseaux-burin
Cinzel

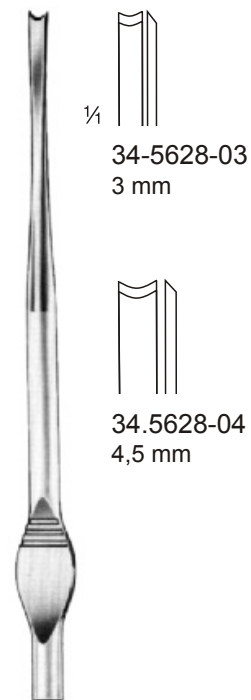

Walter
19,0 cm/7¾"

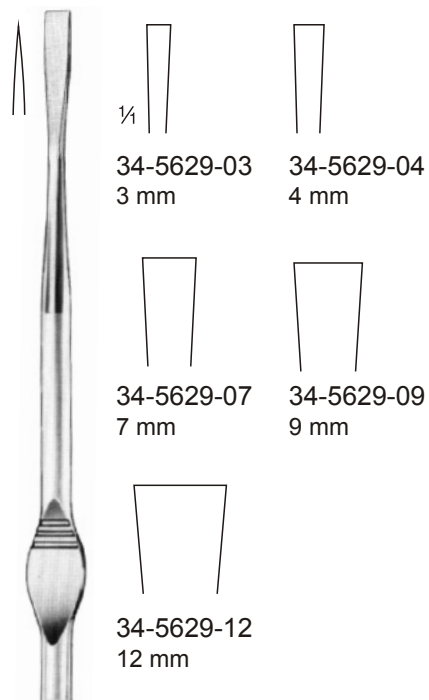

Walter
19,0 cm/7¾"

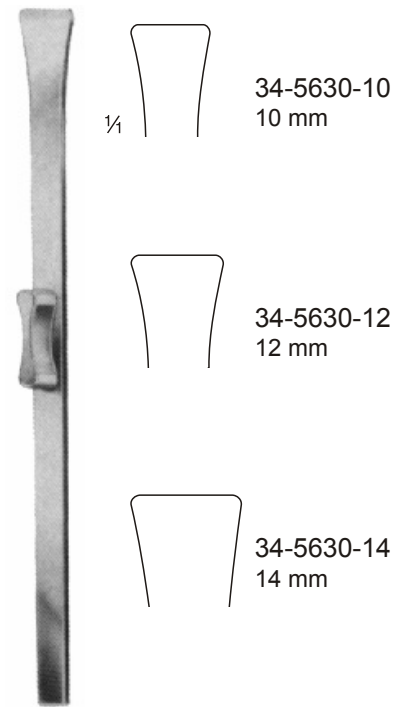

Rubin
18,0 cm/7"





gerade
 straight
 droit
 recto

Silver

34-5631-01
 18,0 cm/7"



rechts
 right
 à droite
 a la derecha

Silver

34-5631-02
 18,0 cm/7"



links
 left
 à gauche
 a la izquierda

Silver

34-5631-03
 18,0 cm/7"

Flachmeißel, Chisels
 Ciseaux-burins, Cinceles

4 mm



gerade
 straight
 droit
 recto

Freer

34-5632-01
 16,0 cm/6½"

4 mm



gebogen
 curved
 courbe
 curvo

Freer

34-5632-02
 16,0 cm/6½"

6 mm



Freer

34-5633
 15,0 cm/6"

5 mm



Killian

34-5634-01
 17,0 cm/6¾"

5 mm



Killian-Claus

34-5634-02
 17,0 cm/6¾"

Septum-Hohlmeißel, Septum Gouges, Septum gouges, Septum gubias





Joseph
 19,0 cm/7½"

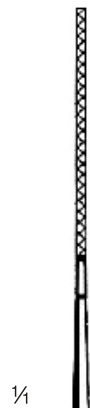

Fig. 1
 34-5635-01

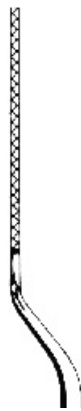

Fig. 2
 34-5635-02



Fig. 3
 34-5635-03

bajonettförmig
 bayonet-shaped
 en forme de baïonnette
 en forma de bayoneta

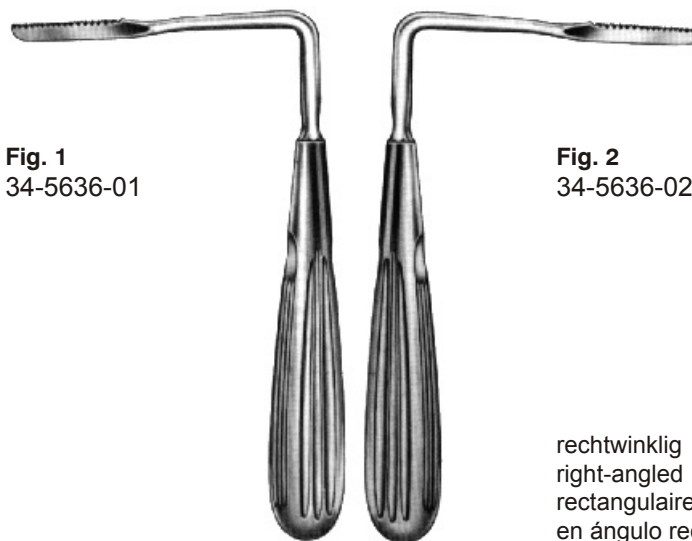

Fig. 1
 34-5636-01

Fig. 2
 34-5636-02

rechtwinklig
 right-angled
 rectangulaire
 en ángulo recto

Joseph
 17,0 cm/6¾"



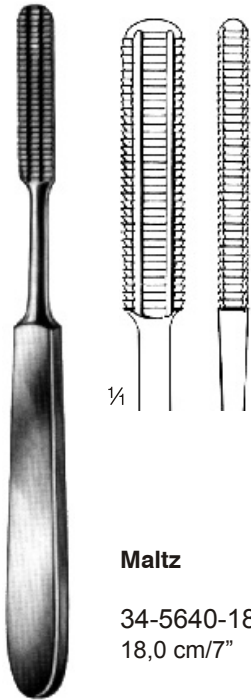

Maltz

34-5640-18
18,0 cm/7"

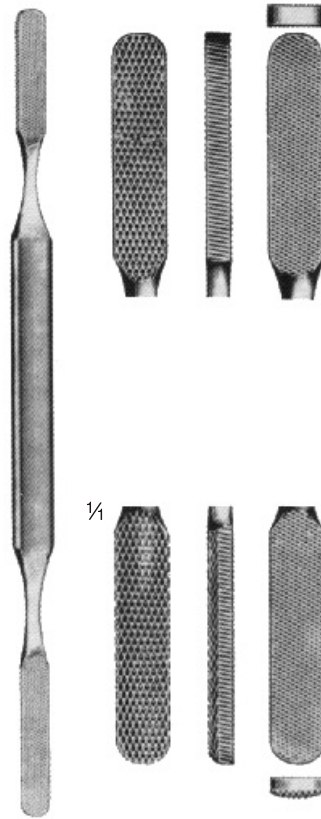

Fomon

34-5641-21
21,0 cm/8¼"

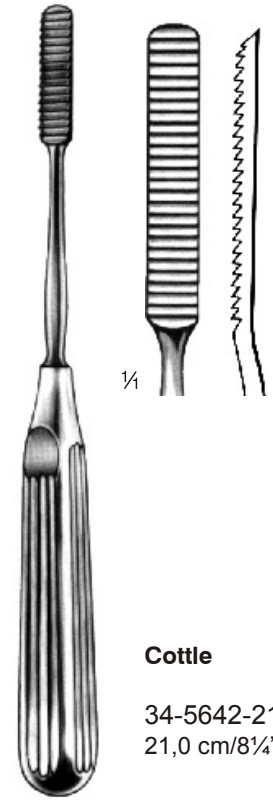

Cottle

34-5642-21
21,0 cm/8¼"

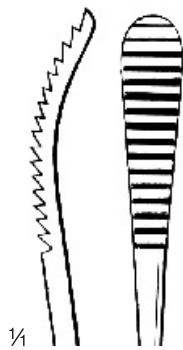

Fig. 1
34-5643-01

Aufricht
21,0 cm/8¼"

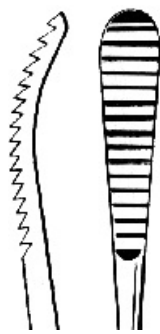

Fig. 2
34-5643-02



Fig. 1
34-5644-01

Wiener
18,0 cm/7"



Fig. 2
34-5644-02

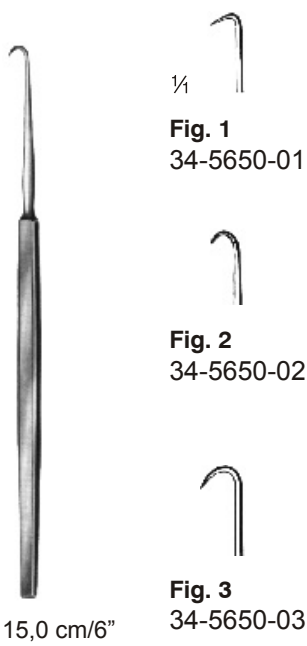

Fig. 1
34-5650-01



Fig. 2
34-5650-02

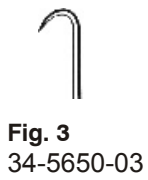

Fig. 3
34-5650-03

15,0 cm/6"



Joseph

34-5651-15
15,0 cm/6"



Cottle

34-5652-16
16,0 cm/6¼"



Choanenhaken
Hook for posterior nares
Crochet boutoné pour
les ailes du nez
Gancho para las coanas

Cottle

34-5654-22
22,0 cm/8¾"



Fomon

34-5655-17
17,0 cm/6¾"



Aufricht

34-5656-19
19,0 cm/7½"



Aufricht

34-5658-14
13,5 cm/5¼"



Kilner

34-5659-10
10,0 cm/4"



Converse

34-5660-12
12,0 cm/4¾"





Freer

34-5661-15
15,0 cm/6"



Joseph

16,0 cm/6 1/4"



34-5663-02
2 mm



34-5663-05
5 mm



34-5663-07
7 mm



34-5663-10
10 mm



Fomon

34-5664-16
16,0 cm/6 1/4"



Cottle-Neivert

34-5665-20
20,0 cm/8"



Cottle

15,0 cm/6"

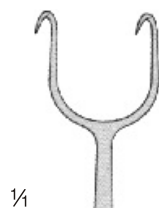

Fig. 1
34-5667-01

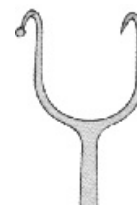

Fig. 2
34-5667-02



Fig. 3
34-5667-03



Cottle

34-5668-14
14,0 cm/5½"



Neivert

34-5669-16
16,0 cm/6¼"



Cottle

34-5670-15
15,0 cm/6"

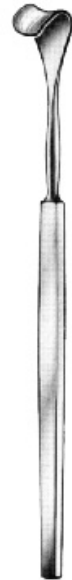

Cottle

34-5671-15
15,0 cm/6"



Ballenger
20,0 cm/8"



34-5680-03
3 mm



34-5680-04
4 mm



34-5680-05
5 mm

gerade
straight
droit
recto



Ballenger
20,0 cm/8"



34-5681-03
3 mm



34-5681-04
4 mm



34-5681-05
5 mm

bajonettförmig
bayonet-shaped
en forme de baïonnette
en forma de bayoneta



Joseph
 15,0 cm/6"



Fig. 1
 34-5685-01



Fig. 2
 34-5685-02



Fomon

34-5686-16
 16,0 cm/6½"



Cottle

34-5687-15
 15,0 cm/6"



Joseph

34-5688-15
 15,0 cm/6"



Converse

34-5689-16
 16,0 cm/6½"



Cottle

34-5690-15
 15,0 cm/6"

¼

4
 3

..



Vogel
34-5700
21,0 cm/8¼"



Beckmann
22,0 cm/8¾"

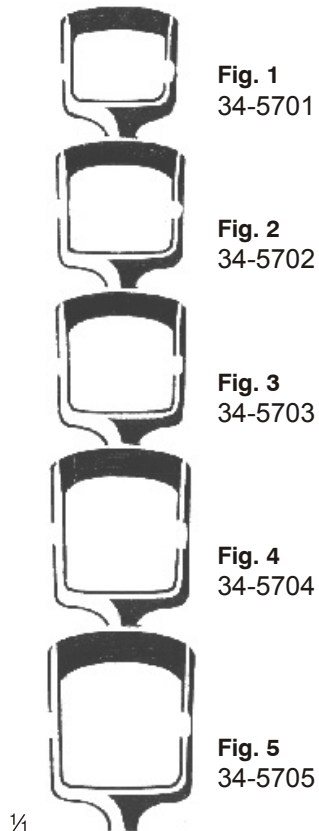

Fig. 1
34-5701

Fig. 2
34-5702

Fig. 3
34-5703

Fig. 4
34-5704

Fig. 5
34-5705



Barnhill
21,0 cm/8¼"



Fig. 1
34-5711

Fig. 2
34-5712

Fig. 3
34-5713

Fig. 4
34-5714



St. Clair-Thomson
21,0 cm/8¼"



Fig. 1
34-5721

Fig. 2
34-5722

Fig. 3
34-5723

Fig. 4
34-5724





La Force
 25,0 cm/10"



Fig. 1



Fig. 2



Fig. 3

1/4

mit gelochter Klinge
 with perforated blade
 à lame perforée
 con hoja perforada

- Fig. 1** 34-5731
- Fig. 2** 34-5732
- Fig. 3** 34-5733

Ersatzklingen
 Spare blades
 Lames de rechange
 Hojas de repuesto

- Fig. 1** 34-5735
- Fig. 2** 34-5736
- Fig. 3** 34-5737





Heister

34-5803
13,0 cm/5"

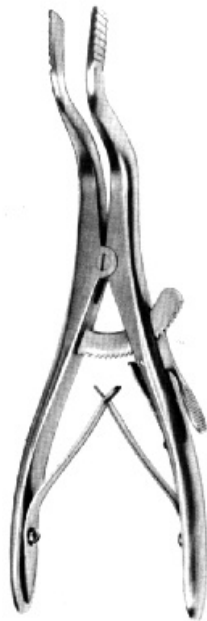

Roser-König

34-5807
16,0 cm/6¼"



Denhart

34-5810
12,0 cm/4¾"



Molt

34-5814 11,0 cm/4½"
34-5815 14,0 cm/5½"



Whitehead

34-5821 11,0 cm/4½"
34-5823 13,0 cm/5"
34-5825 15,0 cm/6"



Jennings

34-5830 9,0 cm/3½"
34-5831 11,0 cm/4½"
34-5833 13,0 cm/5"
34-5835 15,0 cm/6"

Davis-Boyle

Zungenspatel allein, Tongue Depressor only
Abaisse-langue seule, Abaja-lengua suelta



Fig. 1
34-5841
21 x 30 mm

Fig. 2
34-5842
23 x 65 mm

Fig. 3
34-5843
24 x 80 mm

Fig. 4
34-5844
25 x 93 mm

Fig. 5
34-5845
26 x 108 mm



Davis-Boyle

Griff allein, Handle only
Manche seul, Mango suelto

34-5840-01	34-5840-02	34-5840-03
für Erwachsene	für Jugendliche	für Kinder
for adults	for young people	for children
pour adultes	pour jeunes gens	pour enfants
para adultos	para menores	para niños

34-5846

Paar Silikoneinlagen allein
Pair of silicon inserts only
Paire de protection translucid seule
Par de silicon piezas solo

Davis-Boyle

34-5839

Satz, komplett mit:
Griff 34-5840-02, 2 Silikoneinlagen
5 auswechselbaren Zungenspateln 34-5841 - 34-5845

Set, complete with:
handle 34-5840-02, 2 silicon inserts
5 interchangeable tongue depressors 34-5841 - 34-5845

Jeu, complet avec:
manche 34-5840-02, une paire de protection translucid
5 abaisse-langues interchangeables 34-5841 - 34-5845

Juego, completo con:
mango 34-5840-02, un par de silicon piezas
5 abaja-lenguas intercambiables 34-5841 - 34-5845

Mc Ivor

Zungenspatel allein, Tongue Depressor only
Abaisse-langue seule, Abaja-lengua suelta

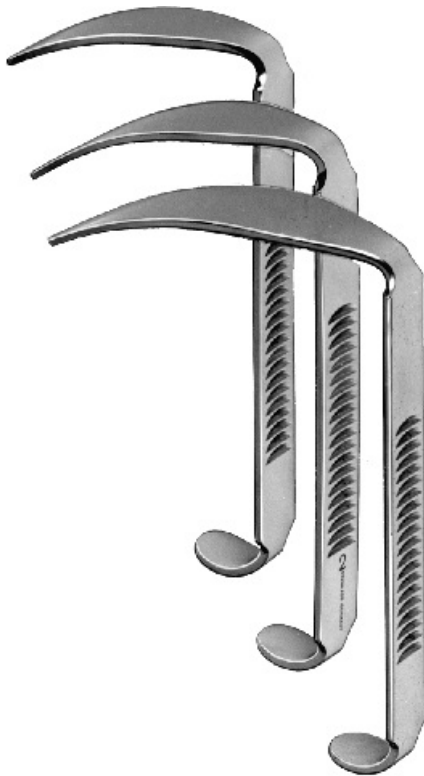

Fig. 1
34-5851
23 x 70 mm

Fig. 2
34-5852
25 x 86 mm

Fig. 3
34-5853
26 x 100 mm



Mc Ivor

34-5850
Griff allein, Handle only
Manche seul, Mango suelto

Mc Ivor

34-5849

Satz, komplett mit:
Griff 34-5850
3 auswechselbaren Zungenspateln 34-5851 - 34-5853

Set, complete with:
handle 34-5850
3 interchangeable tongue depressors 34-5851 - 34-5853

Jeu, complet avec:
manche 34-5850
3 abaisse-langues interchangeables 34-5851 - 34-5853

Juego, completo con:
mango 34-5850
3 abaja-lenguas intercambiables 34-5851 - 34-5853





Negus

Zungenspatel allein, Tongue Depressor only
Abaisse-langue seule, Abaja-lengua suelta

Fig. 1
34-5861
28 x 70 mm

Fig. 2
34-5862
30 x 80 mm

Fig. 3
34-5863
33 x 95 mm



Davis-Boyle

Griff allein, Handle only
Manche seul, Mango suelto

34-5840-01	34-5840-02	34-5840-03
für Erwachsene	für Jugendliche	für Kinder
for adults	for young people	for children
pour adultes	pour jeunes gens	pour enfants
para adultos	para menores	para niños

34-5846

Paar Silikoneinlagen allein
Pair of silicon inserts only
Paire de protection translucid seule
Par de silicon piezas solo

Negus

34-5859

Satz, komplett mit:
Griff 34-5840-02, 2 Silikoneinlagen
3 auswechselbaren Zungenspateln 34-5861 - 34-5863

Set, complete with:
handle 34-5840-02, 2 silicon inserts
3 interchangeable tongue depressors 34-5861 - 34-5863

Jeu, complet avec:
manche 34-5840-02, une pair de protection translucid compris
3 abaisse-langues interchangeables 34-5861 - 34-5863

Juego, completo con:
mango 34-5840-02, un par de silicon piezas
3 abaja-lenguas intercambiables 34-5861 - 34-5863



Kilner-Doughty (Russel-Davis)

Zungenspatel allein, Tongue Depressor only
Abaisse-langue seule, Abaja-lengua suelta



Fig. 1
34-5871
28 x 65 mm

Fig. 2
34-5872
32 x 75 mm

Fig. 3
34-5873
37 x 80 mm

Fig. 4
34-5874
40 x 90 mm

Fig. 5
34-5875
45 x 100 mm



Kilner-Doughty (Russel-Davis)

34-5870
Griff allein, Handle only
Manche seul, Mango suelto

Kilner-Doughty (Russel-Davis)

34-5869

Satz, komplett mit:
Griff 34-5870

3 auswechselbaren Zungendrückern 34-5871 - 34-5873
2 beweglichen auswechselbaren Zahnplatten
1 Gaumenplatte für Zahnlose

Set, complete with:
handle 34-5870

3 interchangeable tongue depressors 34-5871 - 34-5873
2 adjustable and exchangeable tooth plates
1 palatal support for toothless people

Jeu, complet avec:
manche 34-5870

3 abaisse-langues interchangeables 34-5871 - 34-5873
2 supports mobiles et interchangeables des dents
1 support du palais pour édentés

Juego, completo con:
mango 34-5870

3 abaja-lenguas intercambiables 34-5871 - 34-5873
2 soportes de dientes móviles e intercambiables
1 soporte de paladar para desdentados



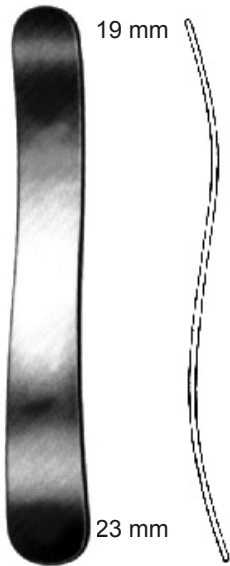

34-5883
14,0 cm/5½"

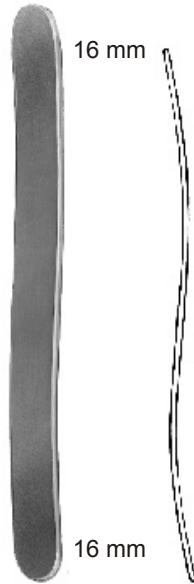

Buchwald
34-5884
14,5 cm/5¾"

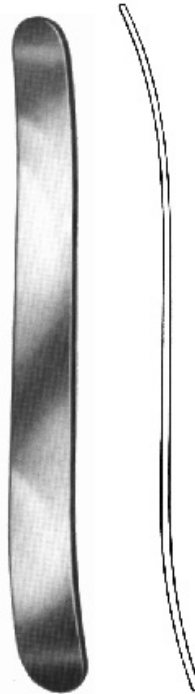

Buchwald
34-5888
18,0 cm/7"



Bruenings
34-5890
19,0 cm/7½"



massiv
solid
massif
macizo

Tobold

34-5891
14,5 cm/5¾"



34-5892
14,0 cm/5½"

34-5893
15,0 cm/6"

Wieder



Doyen

34-5894 13,0 cm/5"
34-5895 16,0 cm/6¼"



Andrew

34-5896
11,0 cm/4½"



Collin

34-5900 17,0 cm/6³/₄"
34-5901 19,0 cm/7¹/₂"



Young

34-5907 16,0 cm/6¹/₄"

34-5907-02

Paar Ersatzgummi
Pair of replacement rubber inserts
Paire de caoutchouc de rechange
Par de goma de recambio



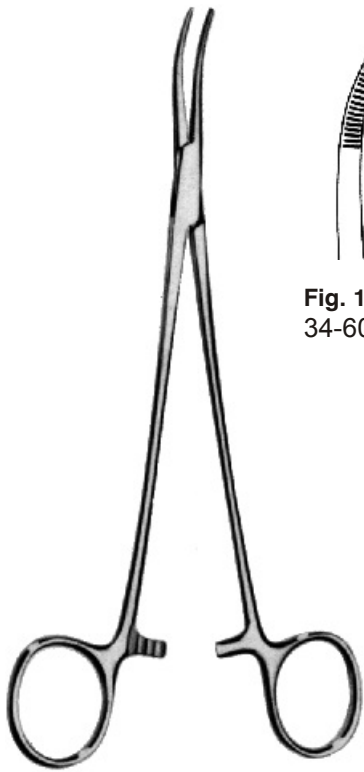

Fig. 1
34-6001



Fig. 2
34-6002

Schmidt
19,0 cm/7½"



Fig. 1
34-6003



Fig. 2
34-6004

Schmidt
19,0 cm/7½"

4
3

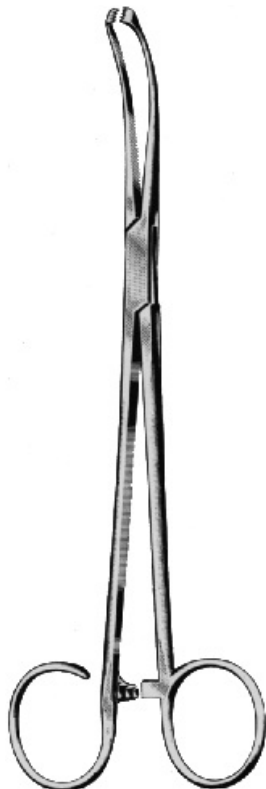

White

34-6005
18,0 cm/7"



Blohmke

34-6006
20,0 cm/8"





Bruenings

34-6010
28,0 cm/11"



Eves

34-6011
28,0 cm/11"



Eves

34-6012
28,0 cm/11"

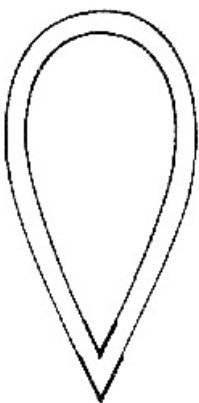

34-6010-40 0,4 mmØ/40 mm
34-6010-50 0,4 mmØ/50 mm
Drahtschlingen gelötet für Bruenings
(Bündel à 100 Stück)
Snare wires for Bruenings, soldered
(package of 100 pieces)
Anses soudées pour Bruenings
(paquet à 100 pièces)
Asas soldadas para Bruenings
(paquete con 100 piezas)



34-6018 0,3 mmØ/100 mm
34-6019 0,3 mmØ/90 mm
Drahtschlingen, geschnitten
(Pack à 12 Stück)
Snare wires, cut
(pack of 12 pieces)
Anses coupées
(paquet à 12 pièces)
Asas preparadas
(paquete con 12 piezas)

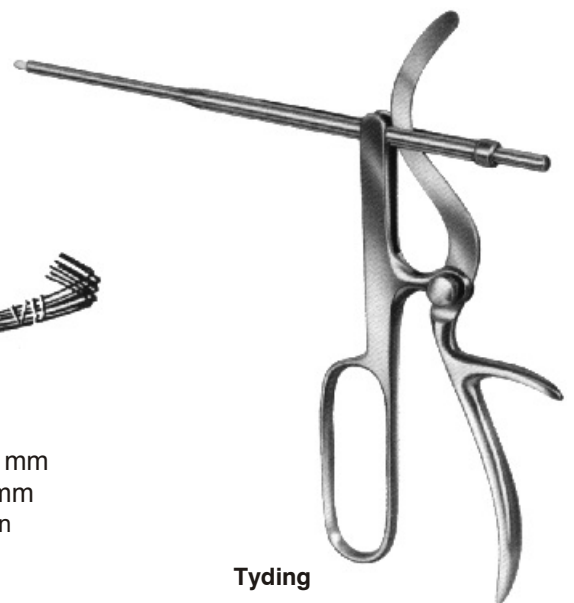

Tyding

34-6013
mit 1 geraden Aufsatz
with 1 straight tip
avec 1 guide-anse droit
con 1 guía-asa recta

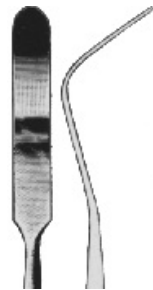
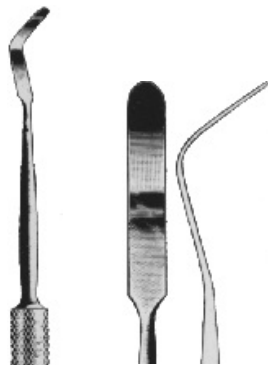

Tonsillennmesser und -enukleator
Tonsil Knives and Enucleators
Bistouris et Enucleateurs pour amygdales
Bisturías y Enucleadores para amígdalas



Carpenter

34-6020-01
25,0 cm/10"

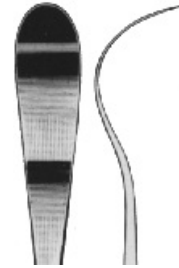

1/4



Carpenter

34-6020-02
24,0 cm/9½"



Tonsillendisektor und -retraktor
Tonsil Dissector and Retractor
Dissecteur et Retracteur pour amygdales
Disecador y Separador para amígdalas

Hurd

34-6021
22,5 cm/9"

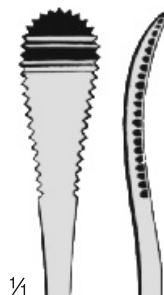

1/4



Henke

Fig. 1
34-6022-01
23,0 cm/9"

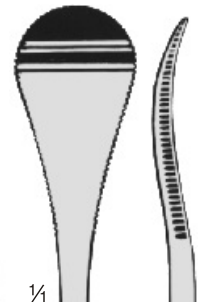

1/4



Henke

Fig. 2
34-6022-02
23,0 cm/9"

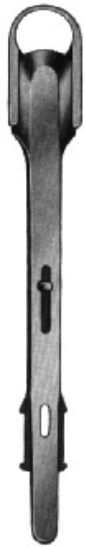

Fig. 1



Fig. 2



Fig. 3

Sluder-Ballenger

34-6025
mit Aufsatz Fig. 1
with tip Fig. 1
avec lame Fig. 1
con hoja Fig. 1

34-6026
mit Aufsatz Fig. 1, Fig. 2
with tip Fig. 1, Fig. 2
avec lame Fig. 1, Fig. 2
con hoja Fig. 1, Fig. 2

34-6027
mit Aufsatz Fig. 1, Fig. 2, Fig. 3
with tip Fig. 1, Fig. 2, Fig. 3
avec lame Fig. 1, Fig. 2, Fig. 3
con hoja Fig. 1, Fig. 2, Fig. 3



Sluder-Ballenger





Buck
16,5 cm/6½"

gerade, straight, droite, recta

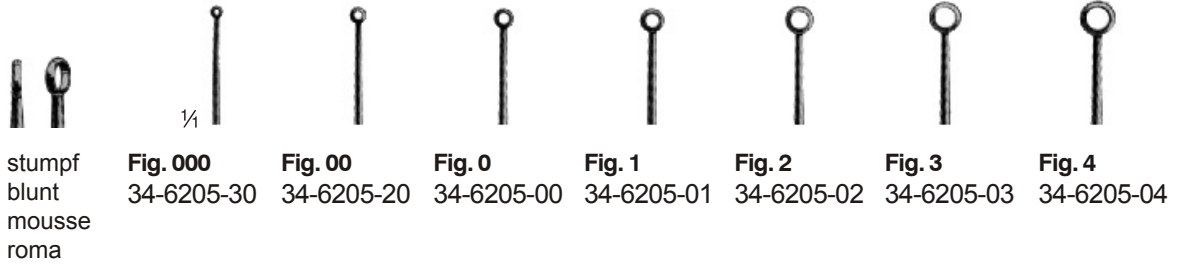

stumpf
blunt
mousse
roma

Fig. 000 34-6205-30 **Fig. 00** 34-6205-20 **Fig. 0** 34-6205-00 **Fig. 1** 34-6205-01 **Fig. 2** 34-6205-02 **Fig. 3** 34-6205-03 **Fig. 4** 34-6205-04



scharf
sharp
tranchante
aguda

Fig. 000 34-6206-30 **Fig. 00** 34-6206-20 **Fig. 0** 34-6206-00 **Fig. 1** 34-6206-01 **Fig. 2** 34-6206-02 **Fig. 3** 34-6206-03 **Fig. 4** 34-6206-04



Buck
16,5 cm/6½"

gebogen, curved, courbe, curva



stumpf
blunt
mousse
roma

Fig. 000 34-6207-30 **Fig. 00** 34-6207-20 **Fig. 0** 34-6207-00 **Fig. 1** 34-6207-01 **Fig. 2** 34-6207-02 **Fig. 3** 34-6207-03 **Fig. 4** 34-6207-04



scharf
sharp
tranchante
aguda

Fig. 000 34-6208-30 **Fig. 00** 34-6208-20 **Fig. 0** 34-6208-00 **Fig. 1** 34-6208-01 **Fig. 2** 34-6208-02 **Fig. 3** 34-6208-03 **Fig. 4** 34-6208-04

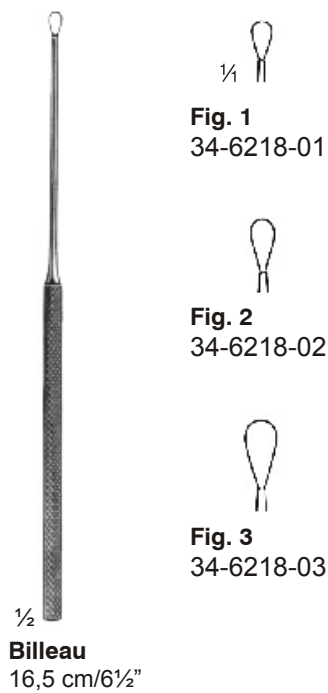
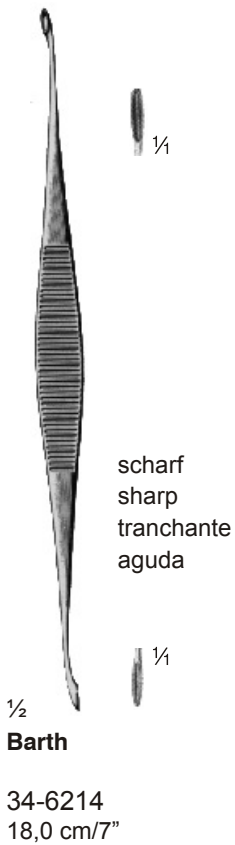
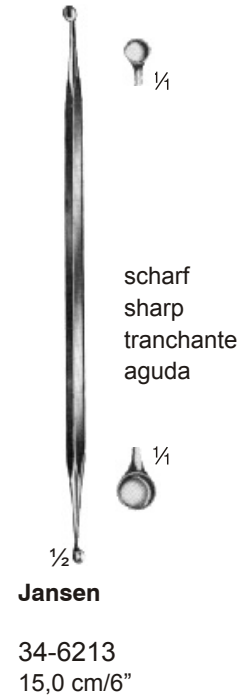
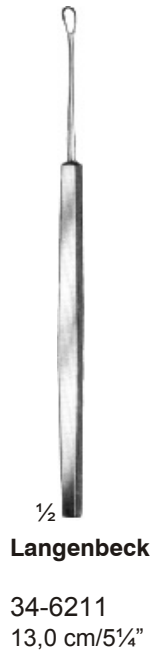
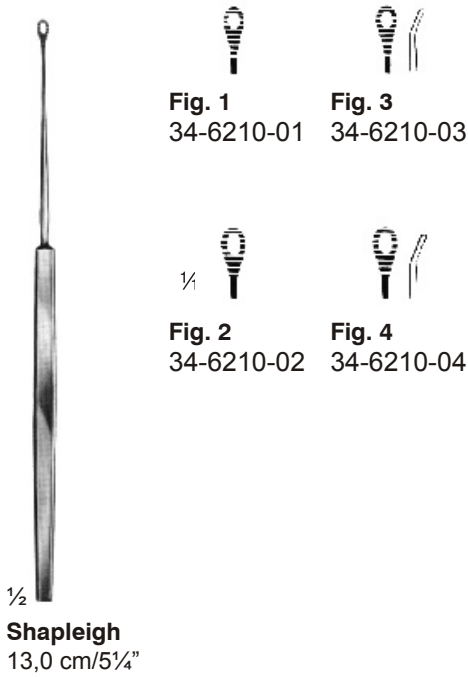

Ohrschlingen
 Ear Loops
 Anses auriculaires
 Asas auriculares



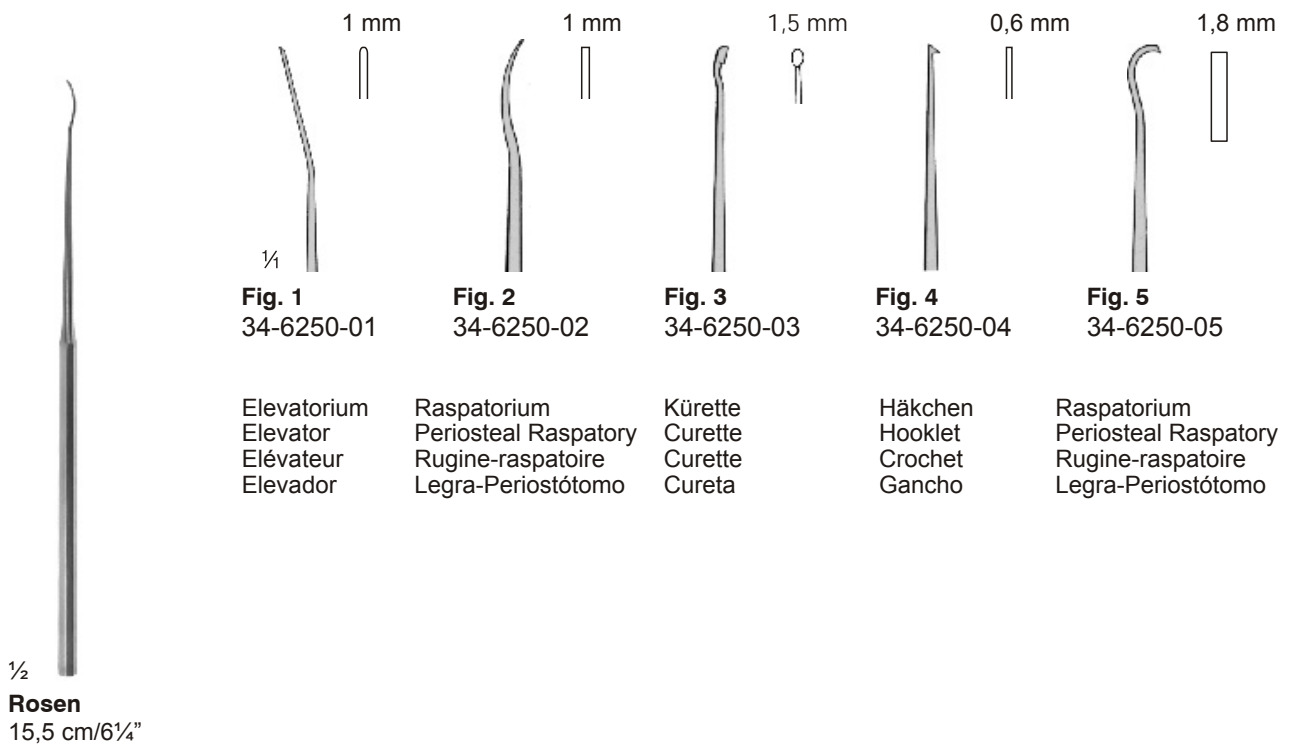
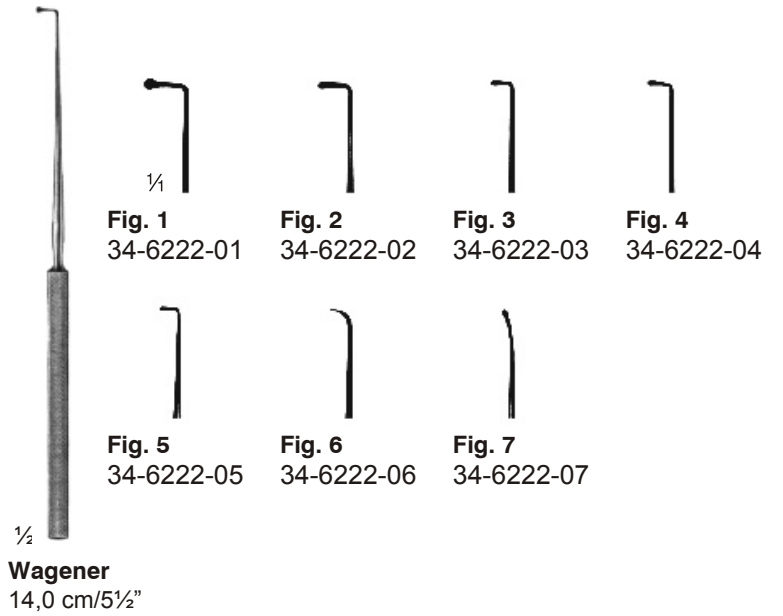
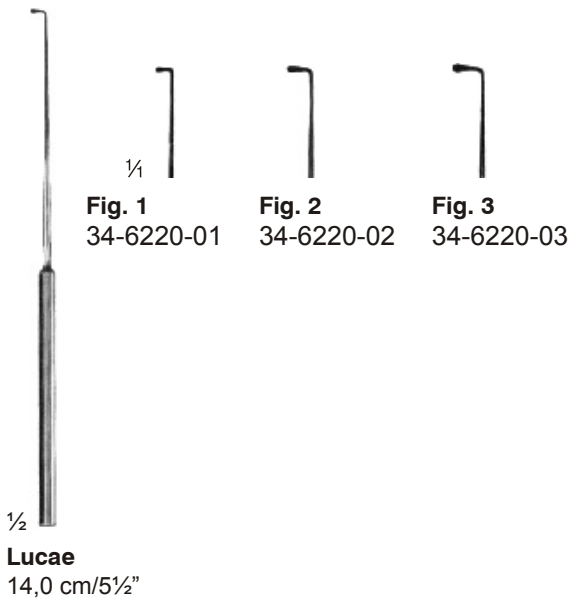

Parazentesenadeln, Paracentesis Needles, Aiguilles à paracentèse, Aguja para paracentesis



Lucae(Royce)

Fig. 1
34-6290-01
18,0 cm/7"



Lucae(Royce)

Fig. 2
34-6290-02
18,0 cm/7"

Nadel quergestellt
Needle horizontal position
Aiguille en position horizontale
Aguja en posición horizontal

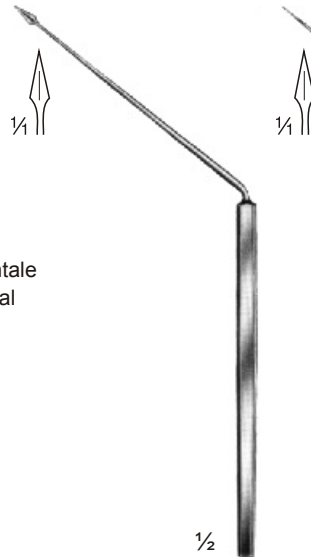

Poltzer

Fig. 1
34-6291-01
16,5 cm/6½"

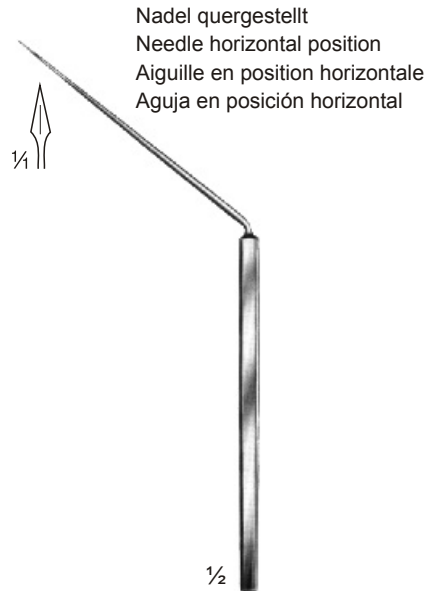

Poltzer

Fig. 2
34-6291-02
16,5 cm/6½"

Nadel quergestellt
Needle horizontal position
Aiguille en position horizontale
Aguja en posición horizontal

Trommelfellmesser, Tympanum Knives, Couteaux à tympan, Cuchillos para tímpano



Sexton

Fig. 1
34-6298-01
18,0 cm/7"



Sexton

Fig. 2
34-6298-02
17,0 cm/6¾"



Sexton

Fig. 3
34-6298-03
17,0 cm/6¾"



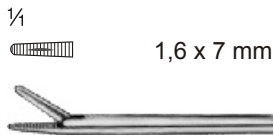
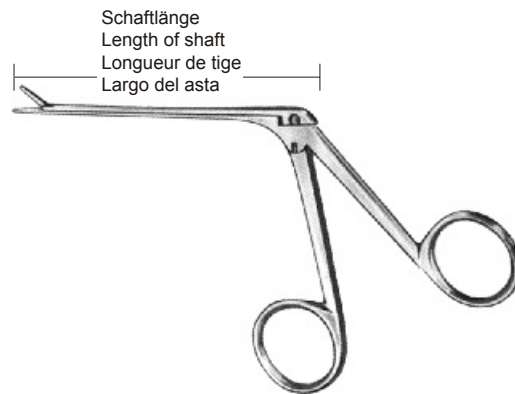

Hartmann-Wullstein
34-6400 8,5 cm/3¾"
Schaftlänge
Length of shaft
Longueur de tige
Largo del asta

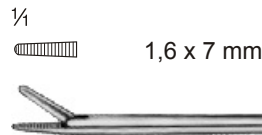

Hartmann
34-6401-08 8,0 cm/3½"
34-6401-14 14,0 cm/5½"
34-6401-16 16,0 cm/6¼"
Schaftlänge
Length of shaft
Longueur de tige
Largo del asta

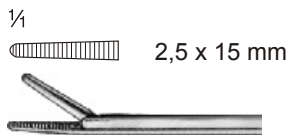

Hartmann-Noyes
34-6406 8,0 cm/3½"
Schaftlänge
Length of shaft
Longueur de tige
Largo del asta

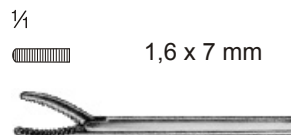

Hartmann-Weingärtner
34-6407 8,0 cm/3½"
Schaftlänge
Length of shaft
Longueur de tige
Largo del asta

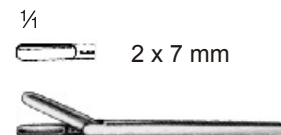

Hartmann
34-6408 8,0 cm/3½"
Schaftlänge
Length of shaft
Longueur de tige
Largo del asta

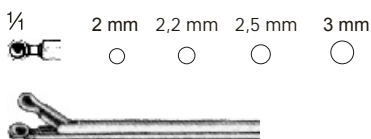

Löffelmaul
Spoon-shaped jaw
Mors en forme d'un cuiller
Boca en forma de cucharilla

Hartmann-Noyes
34-6409-20 2 mm 8,0 cm/3½"
34-6409-22 2,2 mm Schaftlänge
34-6409-25 2,5 mm Length of shaft
34-6409-30 3 mm Longueur de tige
Largo del asta

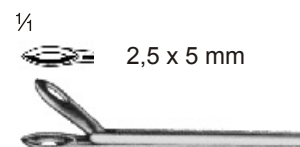

Struempel
34-6410 8,0 cm/3½"
Schaftlänge
Length of shaft
Longueur de tige
Largo del asta

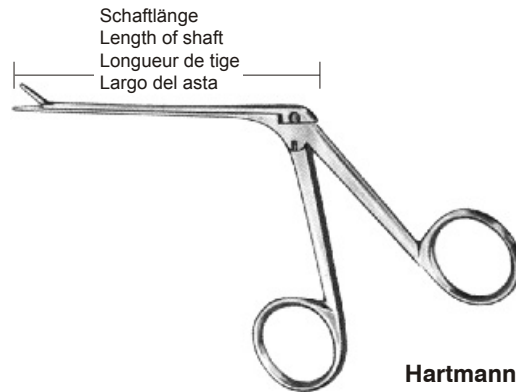

Hartmann

mittelfein

Schaft 1,2 x 1,8 mm
Shaft 1,2 x 1,8 mm
Tige 1,2 x 1,8 mm
Asta 1,2 x 1,8 mm

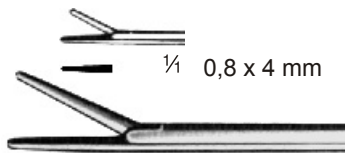

34-6420-01 7,5 cm/3"
glatt
smooth
lisse
lisa
Schaftlänge
Length of shaft
Longueur de tige
Largo del asta

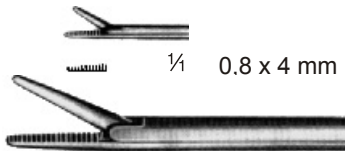

34-6421-01 7,5 cm/3"
gerieft
serrated
strié
estriada
Schaftlänge
Length of shaft
Longueur de tige
Largo del asta

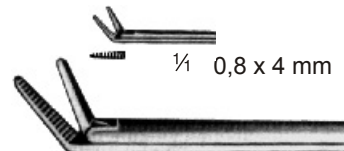

34-6421-02 7,5 cm/3"
gerieft
serrated
strié
estriada
Schaftlänge
Length of shaft
Longueur de tige
Largo del asta

Schaft 1,8 x 2,6 mm
Shaft 1,8 x 2,6 mm
Tige 1,8 x 2,6 mm
Asta 1,8 x 2,6 mm

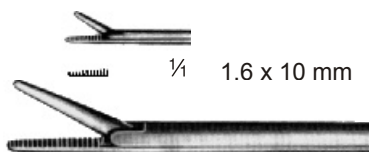

34-6422 gerieft
serrated
strié
estriada
Schaftlänge
Length of shaft
Longueur de tige
Largo del asta

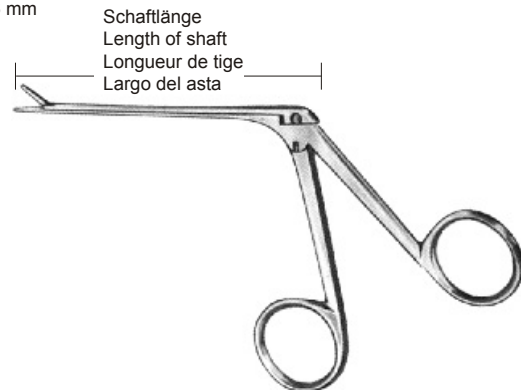

Bellucci



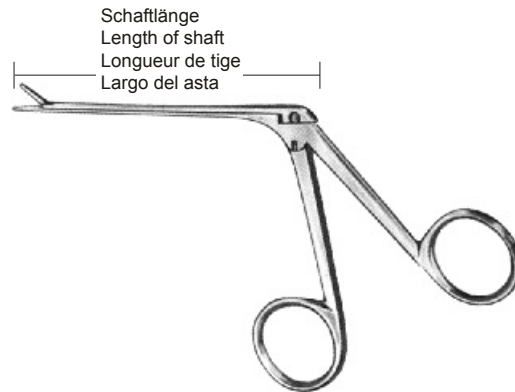

sehr fein

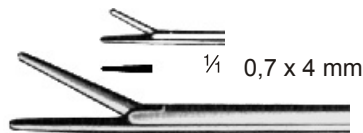

34-6430-01 8,0 cm/3 1/2"
glatt
smooth
lisse
lisa
Schaftlänge
Length of shaft
Longueur de tige
Largo del asta

Schaft 0,8 x 1,8 mm
Shaft 0,8 x 1,8 mm
Tige 0,8 x 1,8 mm
Asta 0,8 x 1,8 mm

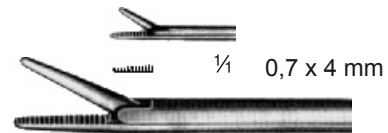

34-6430-02 8,0 cm/3 1/2"
gerieft
serrated
strié
estriada
Schaftlänge
Length of shaft
Longueur de tige
Largo del asta

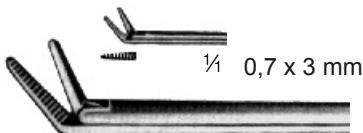

34-6430-03 8,0 cm/3 1/2" nach oben abgewinkelt
gerieft
serrated
strié
estriada
Schaftlänge
Length of shaft
Longueur de tige
Largo del asta
angular upwards
coudée vers le haut
angulada hacia arriba

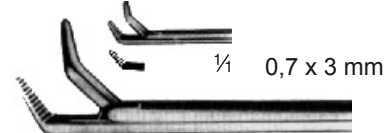

34-6430-04 8,0 cm/3 1/2" nach rechts abgewinkelt
gerieft
serrated
strié
estriada
Schaftlänge
Length of shaft
Longueur de tige
Largo del asta
angular to the right
coudée vers la droite
angulada a la derecha

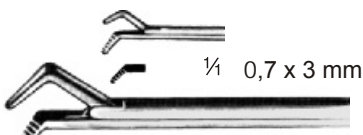

34-6430-05 8,0 cm/3 1/2" nach links abgewinkelt
gerieft
serrated
strié
estriada
Schaftlänge
Length of shaft
Longueur de tige
Largo del asta
angular to the left
coudée vers la gauche
angulada a la izquierda

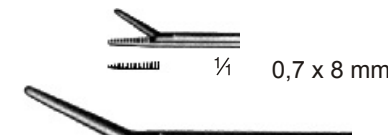

34-6430-06 8,0 cm/3 1/2"
gerieft
serrated
strié
estriada
Schaftlänge
Length of shaft
Longueur de tige
Largo del asta

superfein

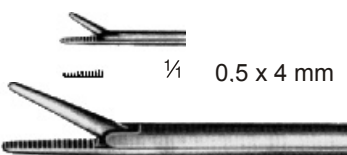

34-6431-01 8,0 cm/3 1/2"
gerieft
serrated
strié
estriada
Schaftlänge
Length of shaft
Longueur de tige
Largo del asta

Schaft 0,6 x 1,5 mm
Shaft 0,6 x 1,5 mm
Tige 0,6 x 1,5 mm
Asta 0,6 x 1,5 mm

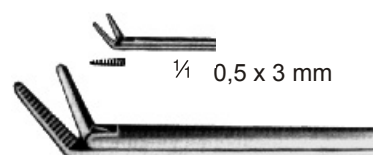

34-6431-02 8,0 cm/3 1/2" nach oben abgewinkelt
gerieft
serrated
strié
estriada
Schaftlänge
Length of shaft
Longueur de tige
Largo del asta
angular upwards
coudée vers le haut
angulada hacia arriba

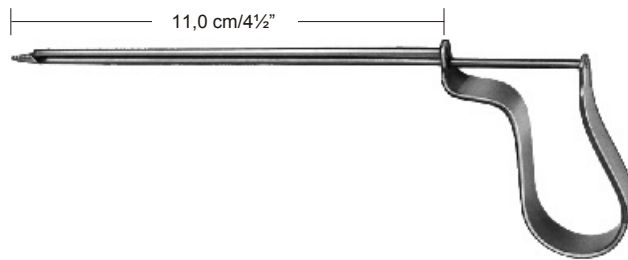

Buck

34-6466
11,0 cm/4 1/2"

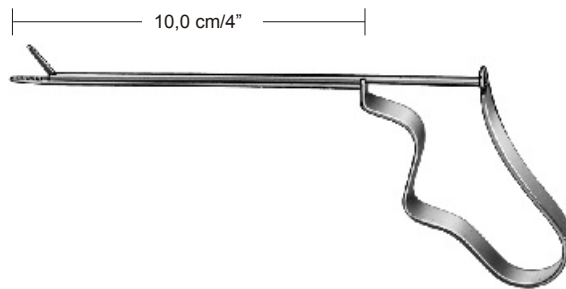

Quire

34-6467
10,0 cm/4"

Augeninstrumente
Ophthalmological Instruments
Instrumentes ophtalmologiques
Instrumentos para oftalmologia

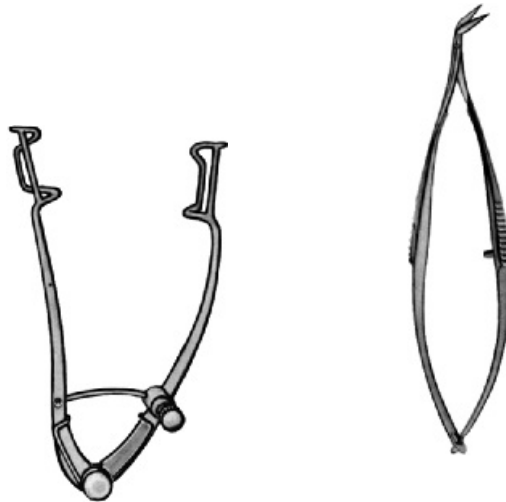



Fixierpinzette
Fixation Forceps
Pince à fixation
Pinzas de fijación

Elschnig

35-7000
10,5 cm/4¼"



Fischer

35-7001
7,0 cm/2¾"

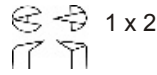

Gill

35-7002
7,5 cm/3"



Zähne unten
Teeth downwards
Dents vers le bas
Dientes hacia abajo

Gill-Hess

35-7003
7,5 cm/3"



35-7004
Zähne seitwärts
Teeth lateral
Dents latérales
Dientes laterales

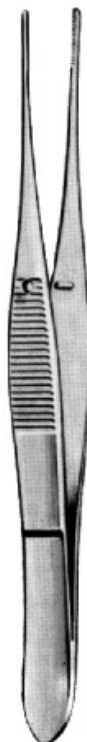

Graefe
10,0 cm/4"
0,9 mm



35-7005



35-7006



35-7007

gerieft
serrated
striée
estriadas



35-7008



35-7009



35-7010





ohne Sperre
without ratchet
sans crémaillère
sin cremallera

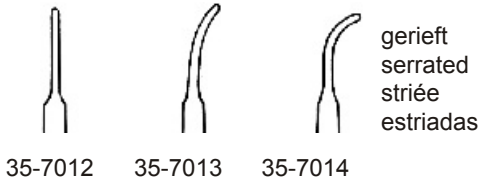

35-7012 35-7013 35-7014

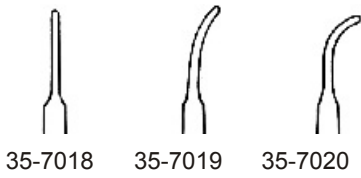

35-7018 35-7019 35-7020

Stevens
10,5 cm/4¼"



mit Sperre
with ratchet
avec crémaillère
con cremallera

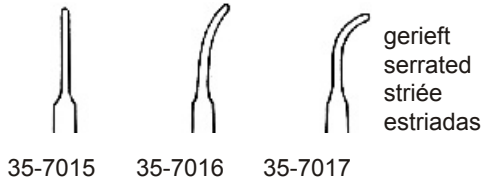

35-7015 35-7016 35-7017

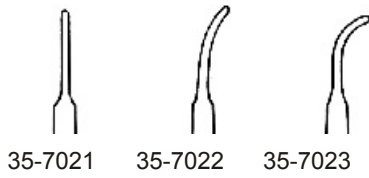

35-7021 35-7022 35-7023

Stevens
10,5 cm/4¼"

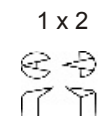

1 x 2



35-7024



35-7029

Hess
7,0 cm/2¾"

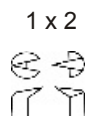

1 x 2



ohne Stift
without pin
sans cheville
sin perno

35-7025-01
7,0 cm/2¾"



1 x 2



mit Stift
with pin
avec cheville
con perno

Mod. Bonn
35-7025-02
7,0 cm/2¾"



35-7026-01
0,8 mm
gerieft
serrated
striée
estriadas

35-7026-02
0,4 mm
gerieft
serrated
striée
estriadas

Bishop-Harmon
8,5 cm/3½"



1 x 2



35-7027-01
0,8 mm

35-7027-02
0,4 mm

Bishop-Harmon
8,5 cm/3½"

Kapselpinzetten, Capsular Forceps, Pincers capsulaires, Pinzas capsulares

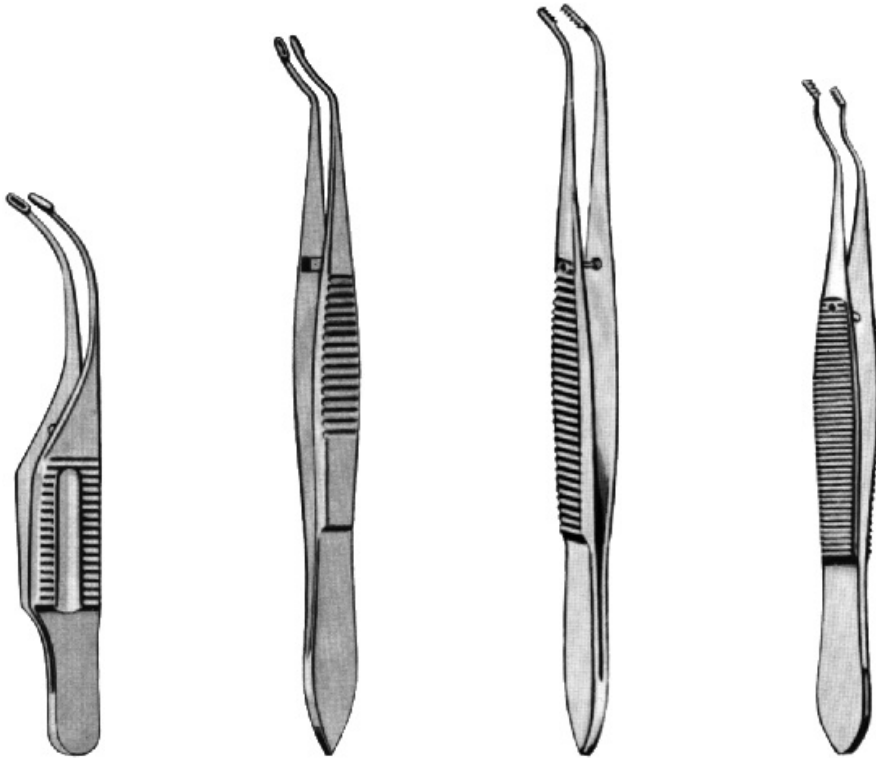

Kapselsauger
Erisophakes
Aspirateurs capsulaires
Aspirador capsular



Gill-Arruga

Arruga

Schweiger

Pley

Dastoor

35-7050
7,5 cm/3"

35-7051
9,5 cm/3¾"

35-7052
10,0 cm/4"

35-7053
9,0 cm/3½"

35-7054
6,0 cm/2½"

Fadenpinzetten, Suture Forceps, Pincers à sutures, Pinzas para sutura

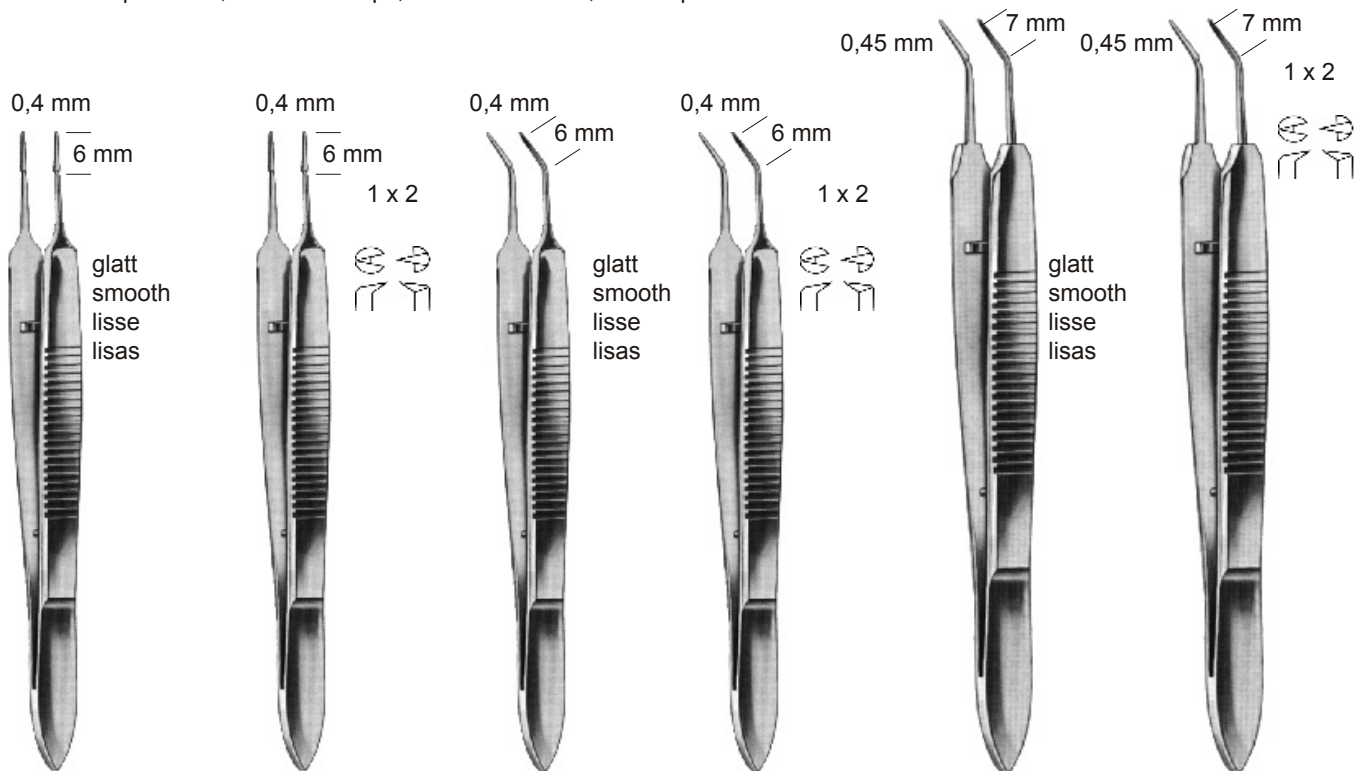

McPherson

McPherson

McPherson

McPherson

McPherson

McPherson

35-7055-01
8,5 cm/3½"

35-7055-02
8,5 cm/3½"

35-7056-01
8,5 cm/3½"

35-7056-02
8,5 cm/3½"

35-7058-01
10,0 cm/4"

35-7058-02
10,0 cm/4"



ohne Schloß
without catch
sans arrêt
sin cierre

Graefe

35-7060
11,0 cm/4½"



mit Schloß
with catch
avec arrêt
con cierre

Graefe

35-7061
11,0 cm/4½"

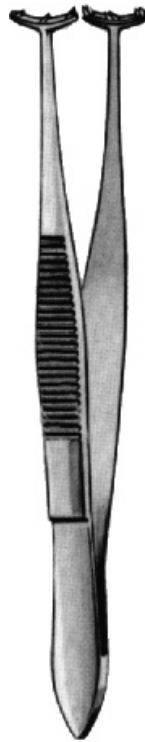

Barraquer

35-7062
10,0 cm/4"

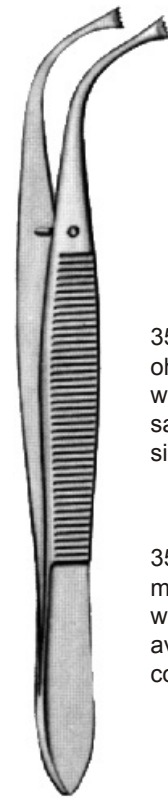

35-7063
ohne Schloß
without catch
sans arrêt
sin cierre

35.7064
mit Schloß
with catch
avec arrêt
con cierre

Noyes

11,0 cm/4½"



Jess

35-7065
10,0 cm/4"

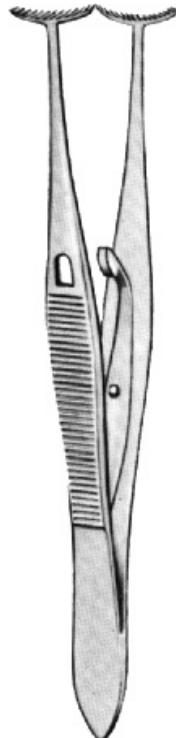

35-7066 5 mm
35-7067 10 mm
mit Schloß
with catch
avec arrêt
con cierre

35-7068 5 mm
35-7069 10 mm
ohne Schloß
without catch
sans arrêt
sin cierre

Green

10,0 cm/4"

2 x 2



Nahtpinzetten
Suture Forceps
Pincas à sutures
Pinzas para sutura

35-7070
gerade
straight
droite
rectas

35-7071
gebogen
curved
courbe
curvas

Castroviejo 2 x 2

9,0 cm/3¾"



Strabismuspinzette
Strabismus Forceps
Pinces à strabisme
Pinzas para estrabismo

Bonaccolto

35-7080
10,0 cm/4"



1 x 2
Nahtpinzetten
Suture Forceps
Pinces à sutures
Pinzas para sutura

35-7084
0,5 mm
35-7085
1,0 mm
gerade
straight
droite
rectas

Castroviejo
10,0 cm/4"



1 x 2
Nahtpinzetten
Suture Forceps
Pinces à sutures
Pinzas para sutura

35-7086
0,5 mm
35-7087
1,0 mm
gebogen
curved
courbe
curvas

Castroviejo
10,0 cm/4"

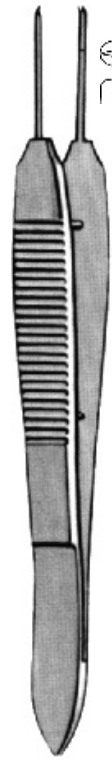

1 x 2
Nahtpinzetten
Suture Forceps
Pinces à sutures
Pinzas para sutura

35-7088-05
0,5 mm
35-7088-09
0,9 mm
35-7088-15
1,5 mm
gerade
straight
droite
rectas

Castroviejo
10,0 cm/4"

1 x 2



Nahtpinzetten
Suture Forceps
Pinces à sutures
Pinzas para sutura

St. Martin

35-7089
7,0 cm/2¾"



gerieft
serrated
striée
estriadas

Strabismuspinzette
Strabismus Forceps
Pinces à strabisme
Pinzas para estrabismo

35-7090
11,0 cm/4½"



1 x 2
gerieft
serrated
striée
estriadas

Strabismuspinzette
Strabismus Forceps
Pinces à strabisme
Pinzas para estrabismo

35-7091
11,0 cm/4½"



Chalazionspinzetten, Chalazion Forceps, Pincès à chalazion, Pinzas para chalación

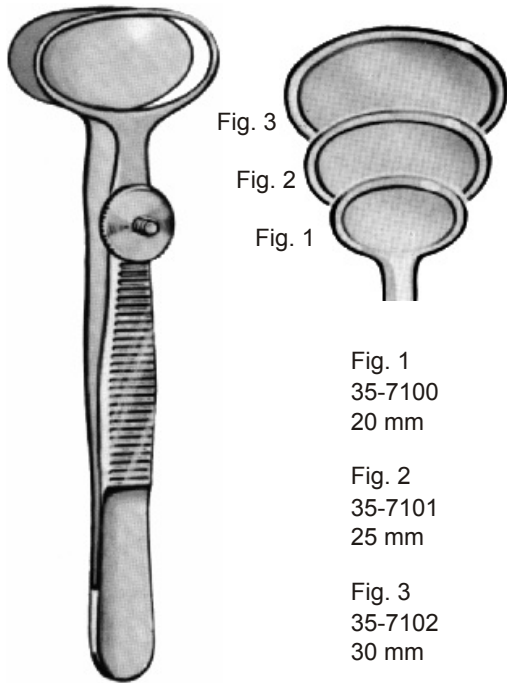

Desmarres
9,0 cm/3½"

Fig. 3

Fig. 2

Fig. 1

Fig. 1
35-7100
20 mm

Fig. 2
35-7101
25 mm

Fig. 3
35-7102
30 mm



Ayer

35-7103
9,0 cm/3½"

mit Schraube
with screw
avec vis
con tornillo

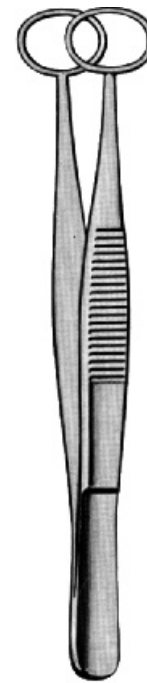

Prince

35-7110
9,0 cm/3½"

Trachospinzette
Trachoma Forceps
Pince pour le trachome
Pinzas para tracoma



10,0 cm/4"

Strabismuspinzette
Strabismus Forceps
Pincès à strabisme
Pinzas para estrabismo



35-7112
35-7113
35-7114

Zähne
Teeth
Griffes
Dientes

1 x 2
2 x 3
3 x 4

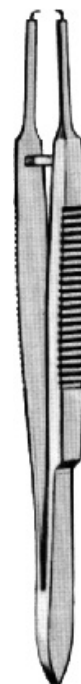

Castroviejo
1 x 1
9,0 cm/3½"

Nahtpinzette
Suture Forceps
Pincès à sutures
Pinzas para sutura

35-7115
mit Schloß
with catch
avec arrêt
con cierre

35-7116
ohne Schloß
without catch
sans arrêt
sin cierre

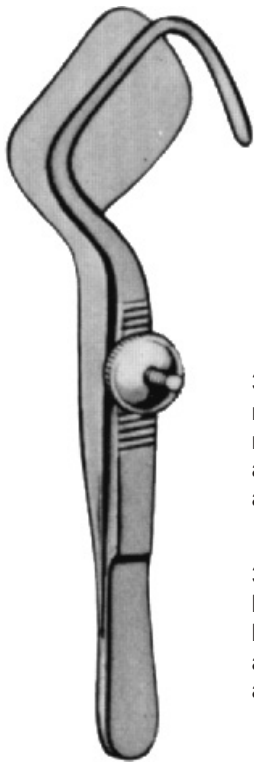

Entropiumpinzetten
Entropium Forceps
Pincès à entropion
Pinzas para entropión

35-7120
rechts
right
à droite
a la derecha

35-7121
links
left
à gauche
a la izquierda

Snellen
10,0 cm/4"

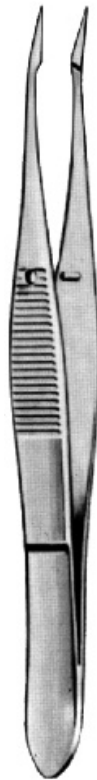

Barraquer

35-7130
10,5 cm/4¼"

Cilienpinzetten, Cilia Forceps
Pincès à épiler les cils, Pinzas para depilación



Bennett

35-7131
7,0 cm/2¾"



Beer

35-7133 8,0 cm/3¼"
35-7134 9,0 cm/3½"

Cilienpinzetten, Cilia Forceps
Pincès à épiler les cils, Pinzas depilatorias



Gradle

35-7135
9,5 cm/3¾"

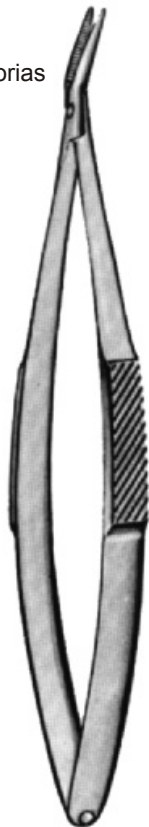

Beaupré

35-7136
12,0 cm/4¾"



1 x 2



0,2 mm

Knüpfpinzette
Suture Tying Forceps
Pincès à poser des ligatures
Pinzas para poner ligaduras

35-7140
9,5 cm/3¾"





Bowman

zylindrisch
cylindrical
cylindrique
cilindrico

Fig.	Ø mm	Neusilber German Silver Maillechort Plata nueva	Silber Silver Argent Plata
000/00	0,8 / 0,7	35-7149	35-7159
00/0	0,9 / 0,8	35-7150	35-7160
0/1	1,0 / 0,9	35-7151	35-7161
1/2	1,1 / 1,0	35-7152	35-7162
2/3	1,2 / 1,1	35-7153	35-7163
3/4	1,3 / 1,2	35-7154	35-7164
4/5	1,4 / 1,3	35-7155	35-7165
5/6	1,5 / 1,4	35-7156	35-7166
6/7	1,6 / 1,5	35-7157	35-7167
7/8	1,7 / 1,6	35-7158	35-7168



gebalt
curved blade
lame courbe
hoja curva



Fig. 1
35-7180



Fig. 2
35-7181



Fig. 3
35-7182



Fig. 4
35-7183



Fig. 5
35-7184



Fig. 6
35-7185



12,5 cm/5"

spitz
pointed blade
lame pointue
hoja aguda



Fig. 7
35-7186



Fig. 8
35-7187



Fig. 9
35-7188



Fig. 10
35-7189



Fig. 11
35-7190



Fig. 12
35-7191



Starmesser, Cataract Knives, Couteaux à cataracte, Cuchillos para catarata

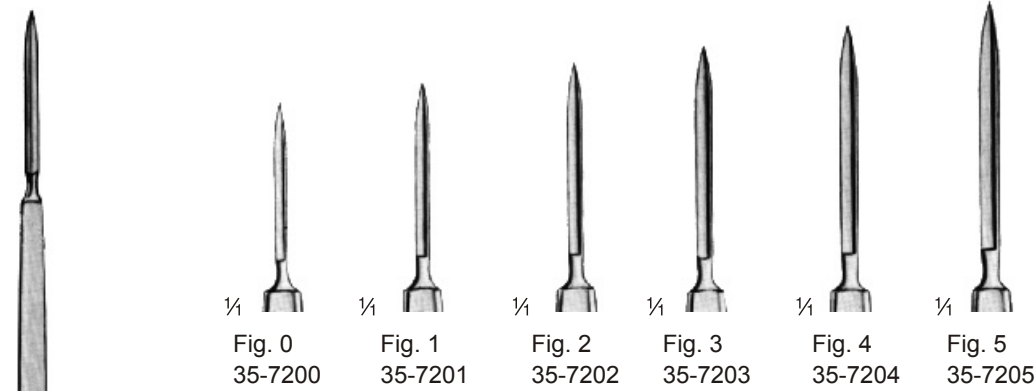

Starmesser, Cataract Knives, Couteaux à cataracte, Cuchillos para catarata

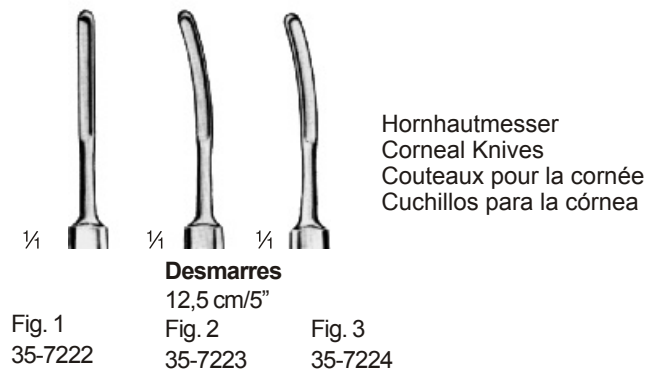
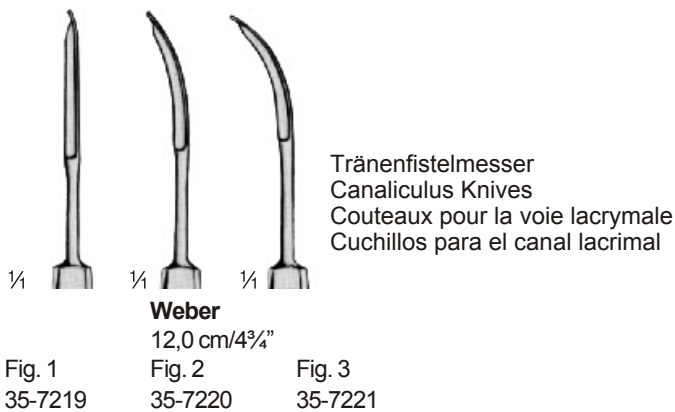
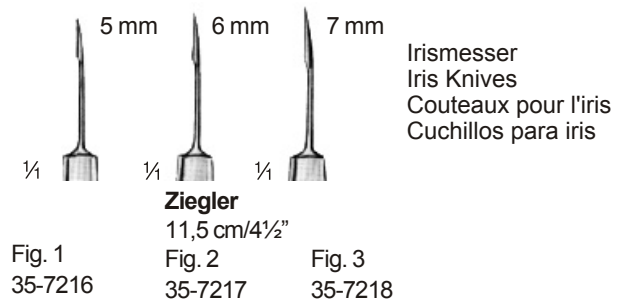
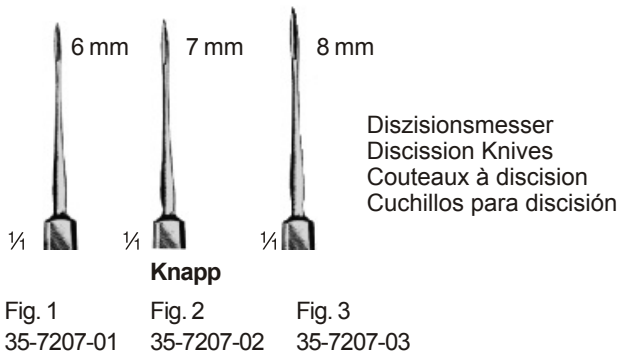
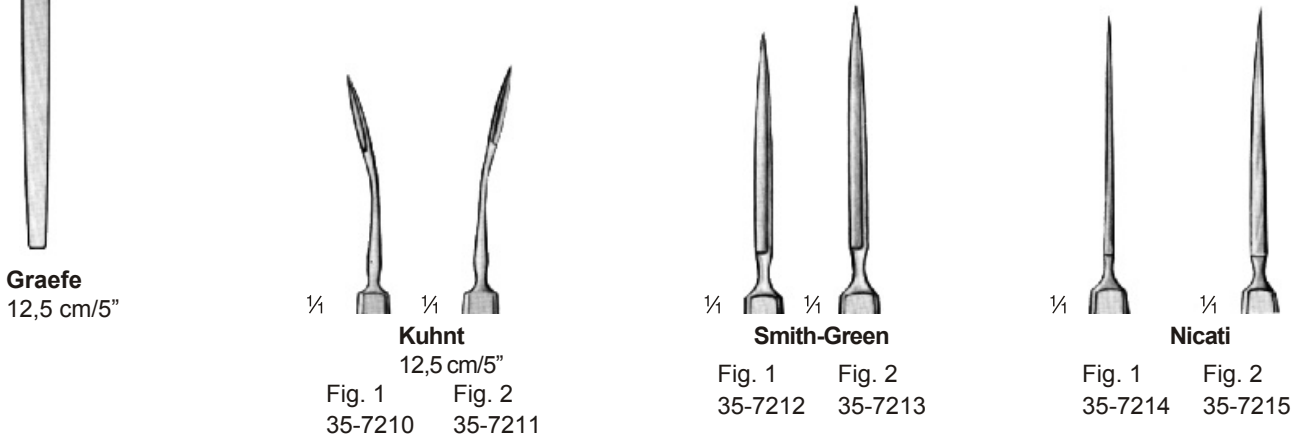

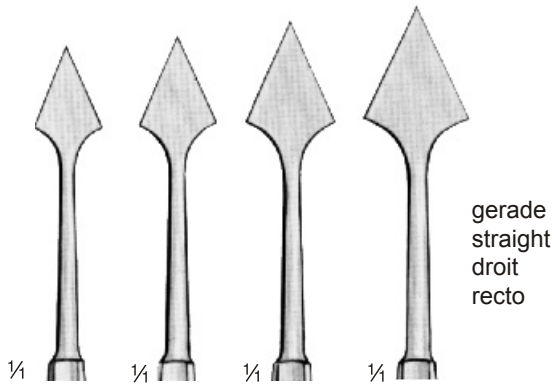

gerade
straight
droit
recto

Jaeger
13,5 cm/5³/₄"

Fig. 1 35-7230 Fig. 2 35-7231 Fig. 3 35-7232 Fig. 4 35-7233

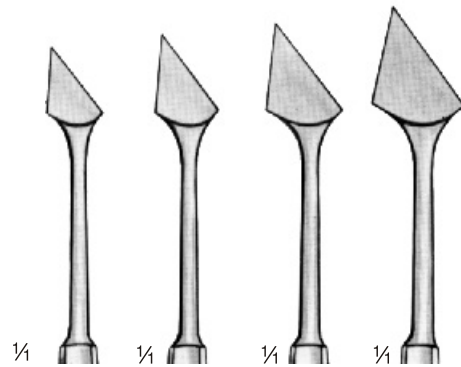

schwach gebogen
slightly curved
légèrement courbe
ligeramente curvo

Jaeger
13,5 cm/5³/₄"

Fig. 1 35-7234 Fig. 2 35-7235 Fig. 3 35-7236 Fig. 4 35-7237

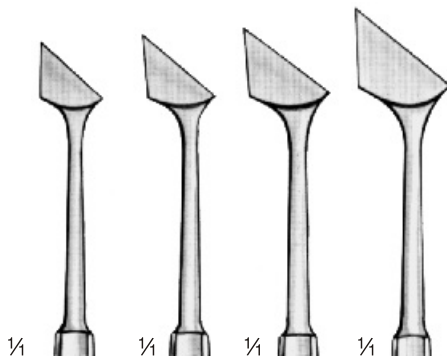

Biegung 45°
Curvature 45°
Courbure de 45°
Curvatura 45°

Jaeger
13,5 cm/5³/₄"

Fig. 1 35-7238 Fig. 2 35-7239 Fig. 3 35-7240 Fig. 4 35-7241

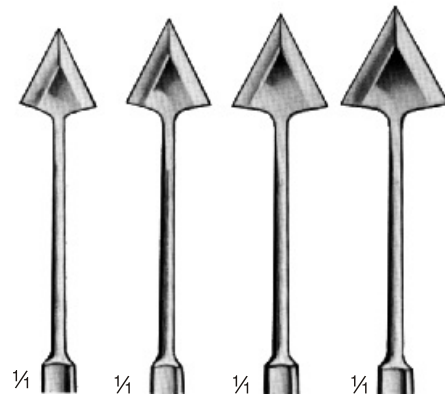

gerade
straight
droit
recto

Jaeger-Grieshaber
13,5 cm/5³/₄"

Fig. 1 35-7242 Fig. 2 35-7243 Fig. 3 35-7244 Fig. 4 35-7245

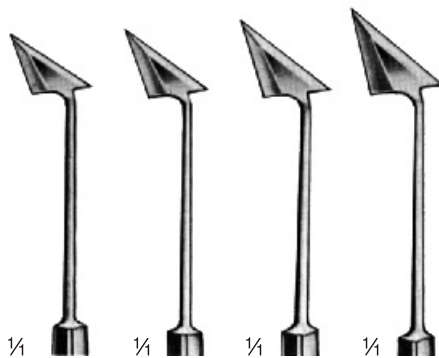

schwach gebogen
slightly curved
légèrement courbe
ligeramente curvo

Jaeger-Grieshaber
13,5 cm/5³/₄"

Fig. 1 35-7246 Fig. 2 35-7247 Fig. 3 35-7248 Fig. 4 35-7249

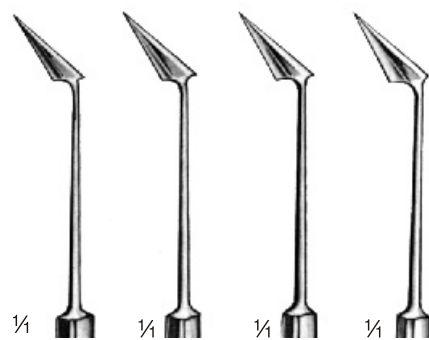

Biegung 45°
Curvature 45°
Courbure de 45°
Curvatura 45°

Wessely-Grieshaber
13,5 cm/5³/₄"

Fig. 1 35-7250 Fig. 2 35-7251 Fig. 3 35-7252 Fig. 4 35-7253



Fremdkörperinstrumente
Foreign Body Instruments
Instrumentes à corps étrangers
Instrumentos para cuerpos extraños

Starnadel
 Cataract Needle
 Aiguille à cataracte
 Aguja para catarata

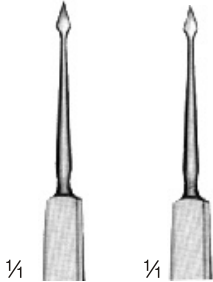

35-7254	35-7255
12,0 cm/4¾"	12,0 cm/4¾"
gerade	gebogen
straight	curved
droite	courbe
recta	curva

Fremdkörpernadel
 Foreign Body Needle
 Aiguille à corps étrangers
 Aguja para cuerpos extraños

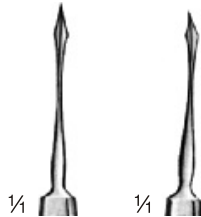

35-7256	35-7257
12,0 cm/4¾"	12,0 cm/4¾"
gerade	gebogen
straight	curved
droite	courbe
recta	curva

Fremdkörper-Hohlmeißel
 Gouge for foreign bodies
 Gouge pour corps étrangers
 Gubia para cuerpos extraños



Meyer
 H7261
 12,0 cm/4¾"



Fremdkörperschlinge und Magnet
 Foreign Body Remover and Magnetic Eye Probe
 Anse et aimant pour corps étrangers
 Asa e imán para cuerpos extraños

Nadel und Flachmeißel
 Needle and Chisel
 Aiguille et burin
 Aguja y cincel



flacher Griff
 flat handle
 manche plat
 mango llano

35-7258

Dix

35-7266

Nadel und Hohlmeißel
 Needle and Gouge
 Aiguille et gouge
 Aguja y gubia



flacher Griff
 flat handle
 manche plat
 mango llano

Dix

35-7267

Nadel und Flachmeißel
 Needle and Chisel
 Aiguille et burin
 Aguja y cincel



runder Griff
 round handle
 manche ronde
 mango redondo

Dix

35-7268

Nadel und Hohlmeißel
 Needle and Gouge
 Aiguille et gouge
 Aguja y gubia



runder Griff
 round handle
 manche ronde
 mango redondo

Dix

35-7269



Starmesser und Flachmeißel
Cataract Knife and Chisel
Couteaux à cataracte et burin
Cuchillo para catarata y cincel

Graefe

35-7270

Graefe

Augenhäkchen, Eye Hooks, Crochets pour les yeux, Ganchos para los ojos

35-7270



Nadel und Flachmeißel
Needle and Chisel
Aiguille et burin
Aguja y cincel

Graefe

35-7271

Graefe

35-7271



Nadel und Hohlmeißel
Needle and Gouge
Aiguille et gouge
Aguja y gubia

Graefe

35-7272

Graefe

35-7272



scharf
sharp
pointu
agudo

¼

Guthrie

12,0 cm/4¾"

Fig. 1

35-7273



scharf
sharp
pointu
agudo

¼

Guthrie

13,0 cm/5¼"

Fig. 2

35-7274



scharf
sharp
pointu
agudo

¼

Graefe

12,0 cm/4¾"

Fig. 1

35-7275



stumpf
blunt
mousse
romo

¼

Fig. 2

35-7276



scharf
sharp
pointu
agudo

¼

Fig. 1

35-7277



stumpf
blunt
mousse
romo

¼

Fig. 2

35-7278

Wiener

12,5 cm/5"



scharf
sharp
pointu
agudo

¼

Fig. 1

35-7280



scharf
sharp
pointu
agudo

¼

Fig. 2

35-7281

Jaeger

13,0 cm/5¼"



Schielhaken, Strabismus Hooks, Crochets à strabisme, Ganchos para estrabismo

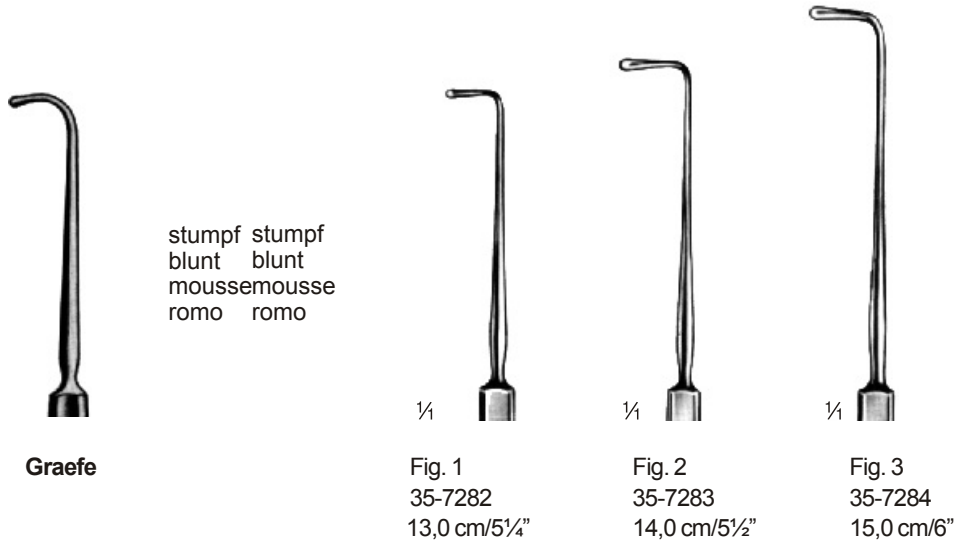

Tränenkanal-Dilatatoren, Lachrymal Dilators, Dilatateurs pour le canal lacrymal, Dilatadores para canal lacrimal

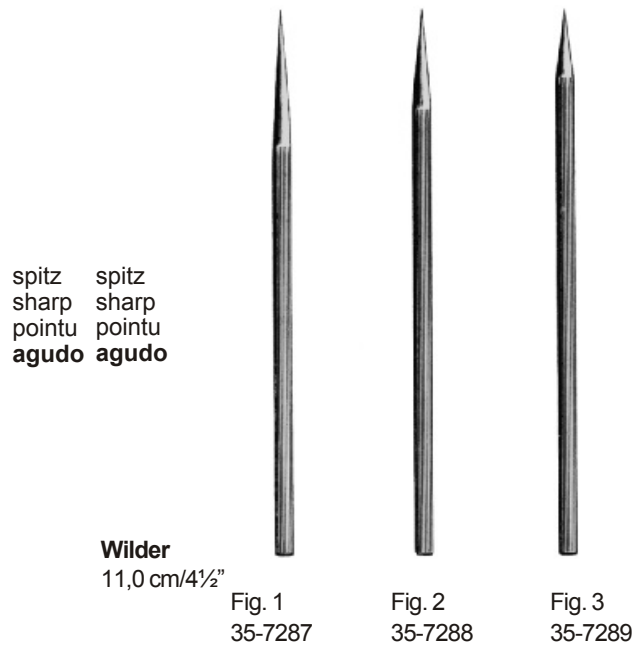

Chalazionslöffel, Chalazion Curettes, Curettes à chalazion, Cucharillas para chalazión

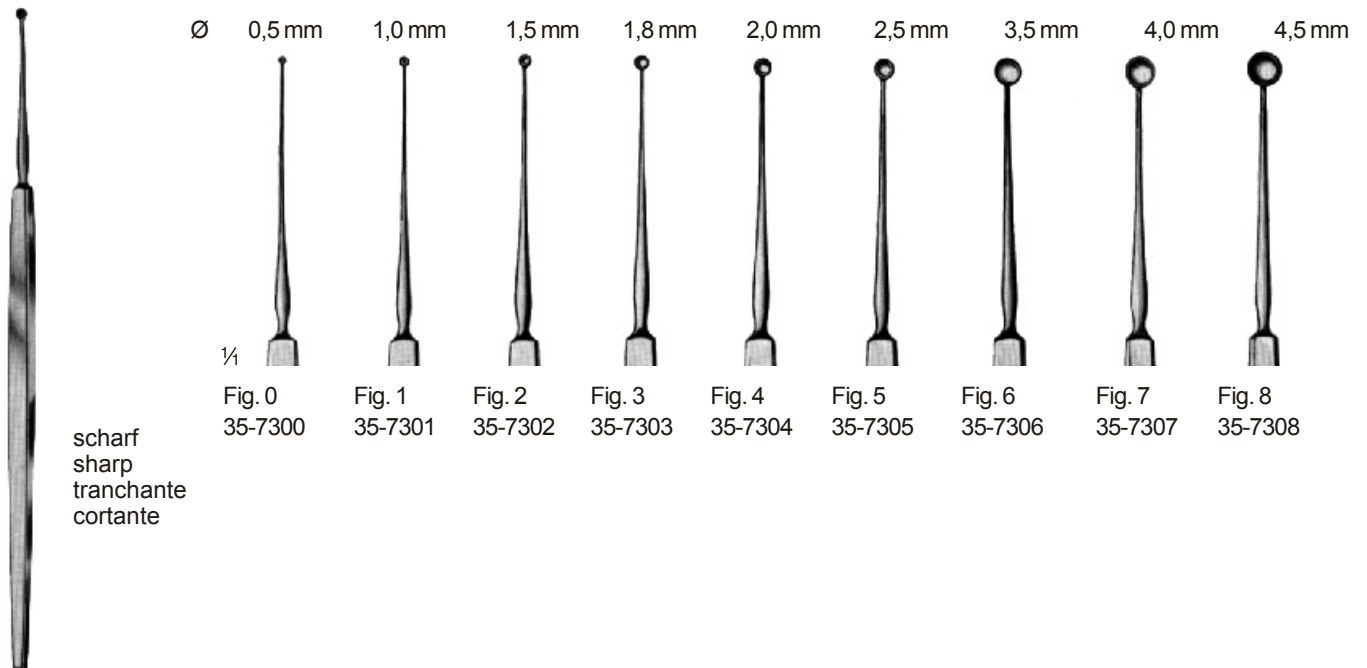

Meyhoefer
13,0 cm/5¼"

Extenterationslöffel, Exenteration Scoops, Curettes pour exentération, Cucharillas para exenteración

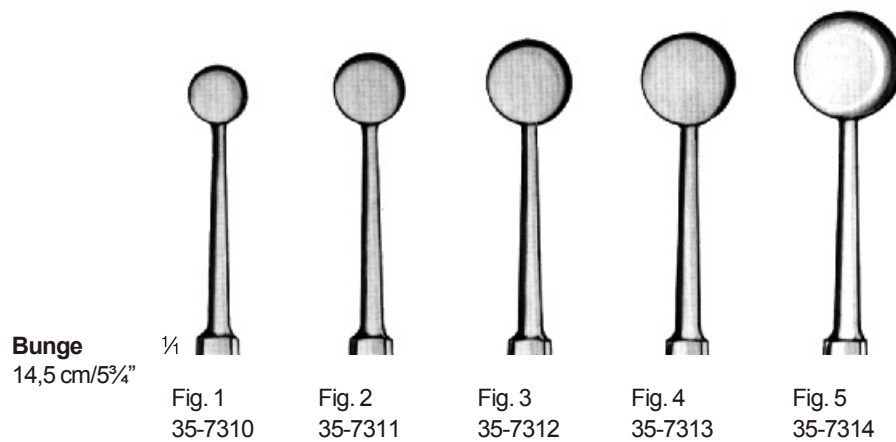

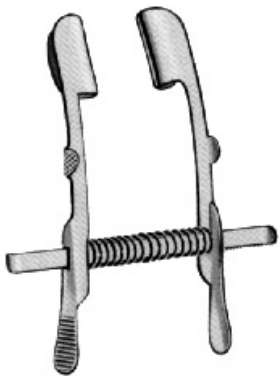

Mellinger-Beard

35-7330	35-7331
5,0 cm/2"	7,0 cm/2¾"
für Kinder	für Erwachsene
for children	for adults
pour enfants	pour adultes
para niños	para adultos

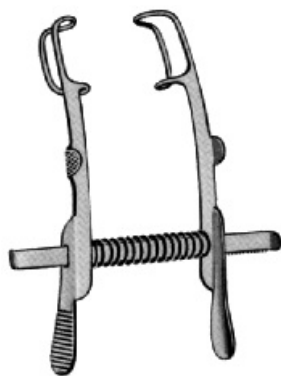

Mellinger

35-7332	35-7333
5,0 cm/2"	7,0 cm/2¾"
für Kinder	für Erwachsene
for children	for adults
pour enfants	pour adultes
para niños	para adultos

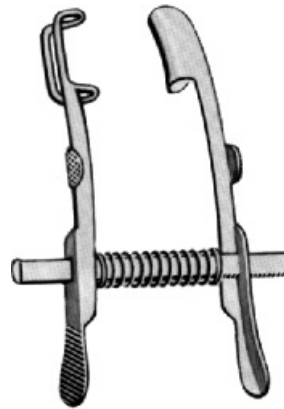

Mellinger-Axenfeld

35-7334
7,0 cm/2¾"
rechts
to the right
à droite
a la derecha

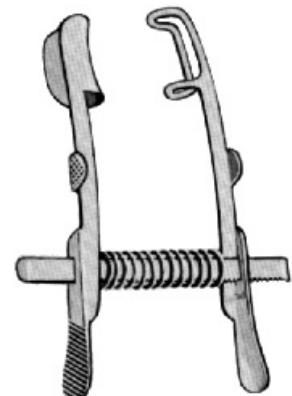

Mellinger-Axenfeld

35-7335
7,0 cm/2¾"
links
to the left
à gauche
a la izquierda



Murdock

35-7336
5,0 cm/2"

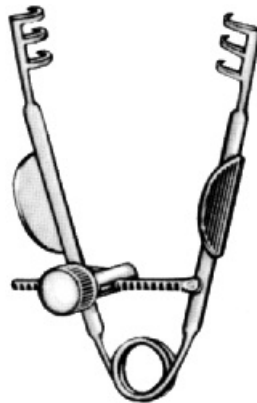

Mueller

35-7337
7,0 cm/2¾"

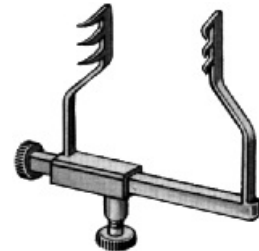

Goldstein

35-7338
3,0 cm/1¼"



Park-Guyton

35-7339
8,0 cm/3¼"



Knapp-Clark

35-7340
8,0 cm/3¼"



Williams

35-7341	35-7342
7,0 cm/2¾"	8,0 cm/3¼"
für Kinder	für Erwachsene
for children	for adults
pour enfants	pour adultes
para niños	para adultos



Lister-Burch

35-7343
8,0 cm/3¼"



Alm

35-7344	7,0 cm/2¾"	35-7345
35-7346	10,0 cm/4"	35-7347
scharf		stumpf
sharp		blunt
pointu		mousse
agudo		romo



Stevenson

35-7348
7,0 cm/2¾"



Castroviejo

35-7349
8,0 cm/3¼"



Lancaster

35-7350
7,0 cm/2¾"



Bowman

35-7351
7,0 cm/2¾"



Lidhalter, Lid Retractor, Ecarteurs à paupières, Separadores de párpados

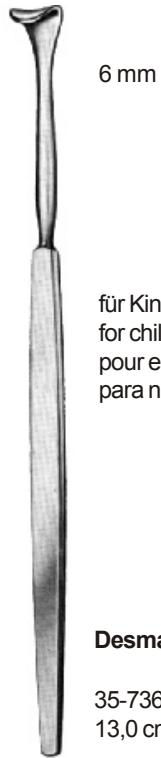

6 mm

für Kinder
for children
pour enfants
para niños

Desmarres

35-7360
13,0 cm/5¼"



Fig. 1
35-7361 12 mm

Fig. 2
35-7362 14 mm

Fig. 3
35-7363 16 mm

Fig. 4
35-7364 18 mm

Desmarres
13,0 cm/5¼"

Markierungszirkel, Marker graduated, Marqueur gradué, Marcador graduado

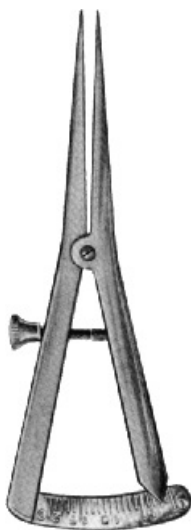

Messbereich
Measuring Range
Echelle
Alcance de medición

35-7370 15 mm
35-7371 20 mm

Castroviejo

Nachstarscheren, Secondary Cataract Scissors
Ciseaux pour la cataracte secondaire, Tijeras para catarata secundaria

Mikro-Scheren
Micro Scissors
Micro-Ciseaux
Micro Tijeras

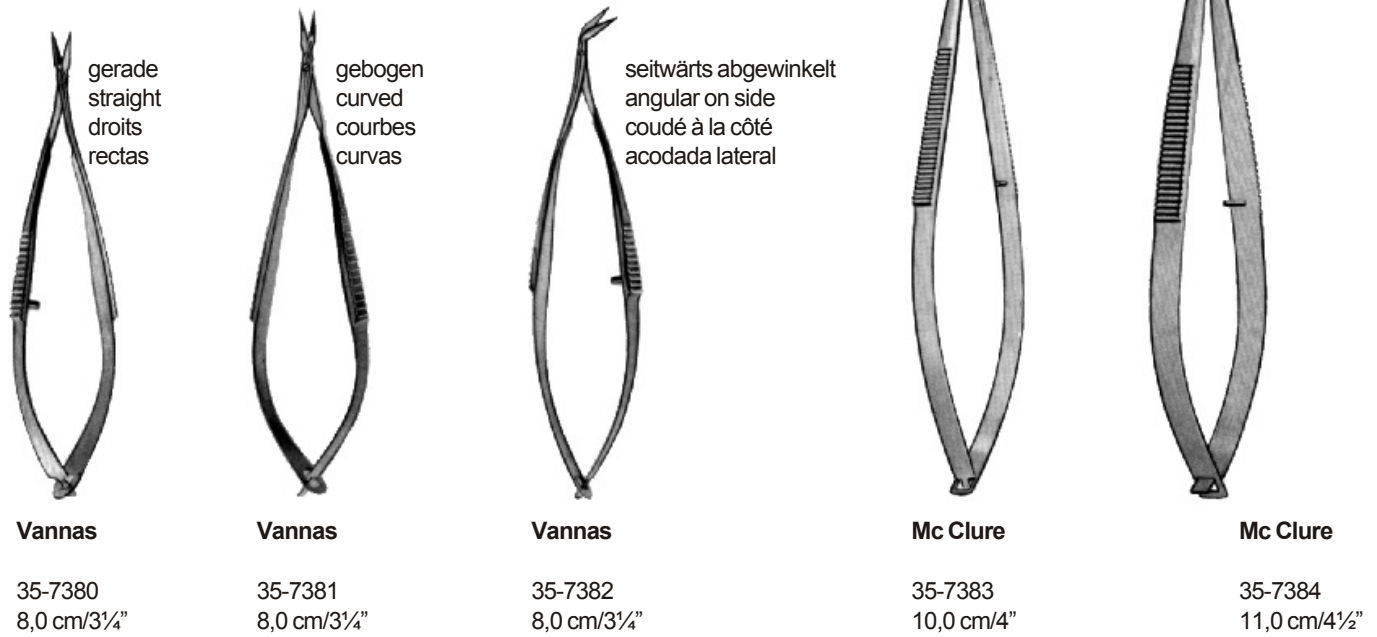

Mikro-Hornhautscheren, Micro Corneal Scissors, Micro-Ciseaux pour la corneé, Micro Tijeras para córnea

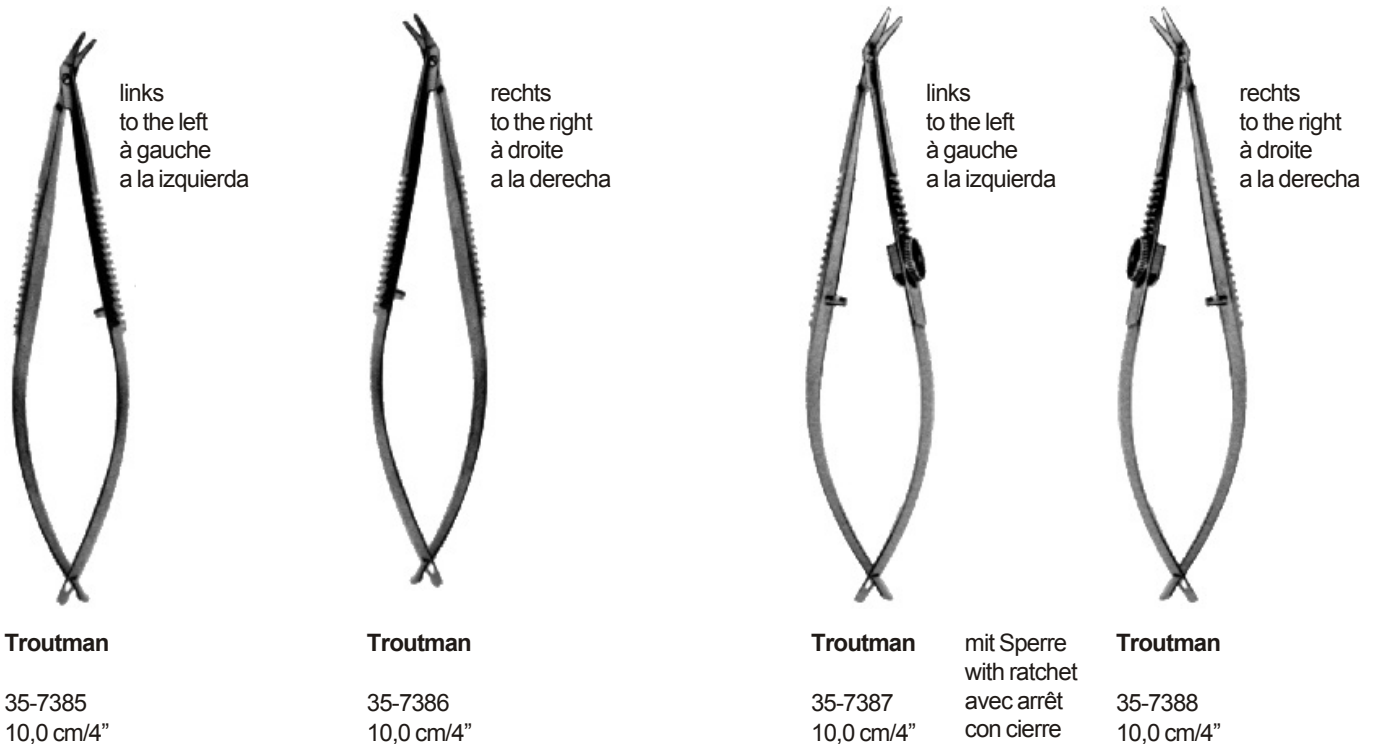

Hornhautscheren, Corneal Scissors, Ciseaux pour la corneé, Tijeras para córnea



links
to the left
à gauche
a la izquierda

Katzin

35-7389
10,0 cm/4"



rechts
to the right
à droite
a la derecha

Katzin

35-7390
10,0 cm/4"



links
to the left
à gauche
a la izquierda

Katzin

35-7391
10,0 cm/4"

mit Sperre
with ratchet
avec arrêt
con cierre



rechts
to the right
à droite
a la derecha

Katzin

35-7392
10,0 cm/4"

Hornhautscheren
Corneal Scissors
Ciseaux pour la corneé
Tijeras para córnea



Mc Guire

35-7393
10,0 cm/4"

Iridektomieschere
Iridectomy Scissors
Ciseaux à iridectomie
Tijeras para iridectomia



Noyes

35-7394
12,0 cm/4¾"

Hornhautscheren
Corneal Scissors
Ciseaux pour la corneé
Tijeras para córnea



Castroviejo

35-7395
9,0 cm/3½"

seitwärts abgewinkelt
angular on side
coudé à la côté
acodada lateral

Sehnenschere
Tenotomy Scissors
Ciseaux à ténotomie
Tijeras para tenotomía



spitz
pointed
pointus
agudos

Westcott

35-7396
11,0 cm/4½"

stumpf
blunt
mousses
romos

Westcott

35-7397
11,0 cm/4½"

Iridektomiescheren, Iridectomy Scissors, Ciseaux à iridectomie, Tijeras para iridectomia

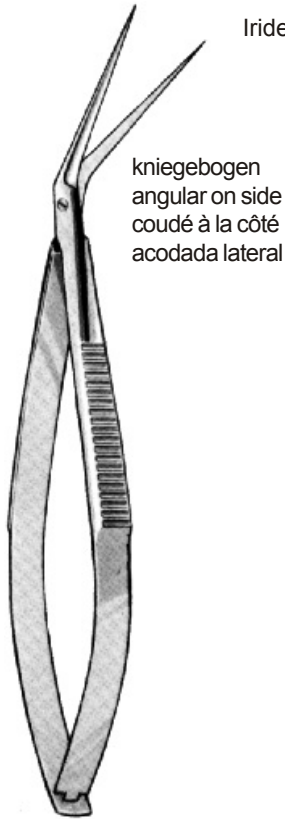

kniegebogen
angular on side
coudé à la côté
acodada lateral

35-7398
11,0 cm/4½"



gebogen
curved
courbes
curvas

35-7399
11,0 cm/4½"



gerade
straight
droits
rectas

35-7400
9,0 cm/3½"



35-7401
9,0 cm/3½"
gebogen
curved
courbes
curvas



35-7402
9,0 cm/3½"
kniegebogen
angular on side
coudé à la côté
acodada lateral

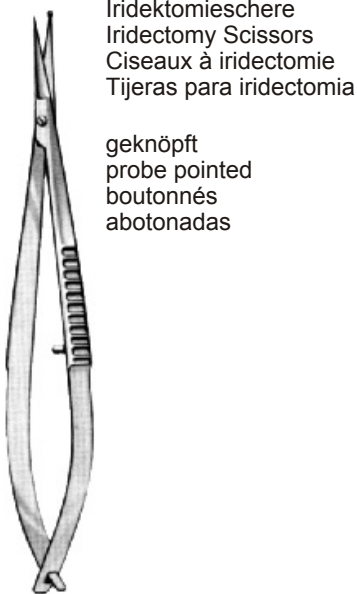

Iridektomieschere
Iridectomy Scissors
Ciseaux à iridectomie
Tijeras para iridectomia

geknöpft
probe pointed
boutonnés
abotonadas

35-7403
9,0 cm/3½"



35-7404
18,0 cm/7"

Iridektomiescheren
Iridectomy Scissors
Ciseaux à iridectomie
Tijeras para iridectomia



35-7404
gerade
straight
droits
rectas



35-7405
gebogen
curved
courbes
curvas



35-7406
gerade
straight
droits
rectas



35-7407
gebogen
curved
courbes
curvas

Rundgriffschere, langes Modell
Micro Scissors with round handle, extra long
Ciseaux avec manche ronde, modèle long
Tijeras con mango redondo, modelo largo



Iridektomiescheren
Iridectomy Scissors
Ciseaux à iridectomie
Tijeras para iridectomia



Fig. 1
35-7408



Fig. 2
35-7409



Fig. 3
35-7410

Noyes
12,0 cm/4¾"

Hornhautscheren
Corneal Scissors
Ciseaux pour la corneé
Tijeras para córnea

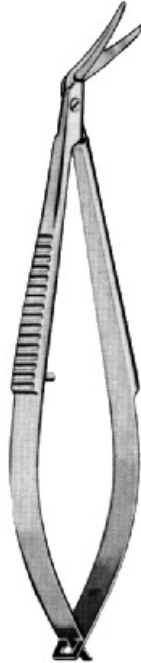

links
to the left
à gauche
a la izquierda

Castroviejo

35-7411
11,0 cm/4½"

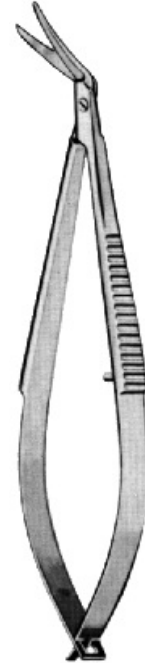

rechts
to the right
à droite
a la derecha

Castroviejo

35-7412
11,0 cm/4½"

Hornhautscheren, Corneal Scissors, Ciseaux pour la corneé, Tijeras para córnea



gebogen
curved
courbes
curvas

Castroviejo

35-7413
9,0 cm/3½"



links
to the left
à gauche
a la izquierda

Castroviejo

35-7414
11,0 cm/4½"

feines Modell
delicate pattern
modèle fin
modelo fino



rechts
to the right
à droite
a la derecha

Castroviejo

35-7415
11,0 cm/4½"

Iridektomiescheren, Iridectomy Scissors, Ciseaux à iridectomie, Tijeras para iridectomia

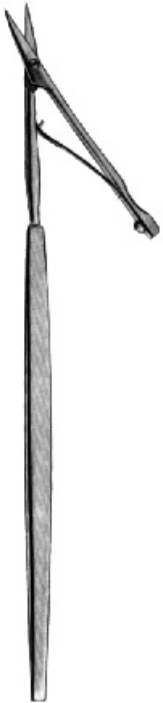

Noyes

35-7416
15,0 cm/6"



Wecker

11,0 cm/4½"



Fig. 1
35-7417



Fig. 2
35-7418



Fig. 3
35-7419



Fig. 4
35-7420



Fig. 5
35-7421



Fig. 6
35-7422

fein
delicate
fins
finos

Hornhautscheren
Corneal Scissors
Ciseaux pour la corneé
Tijeras para córnea

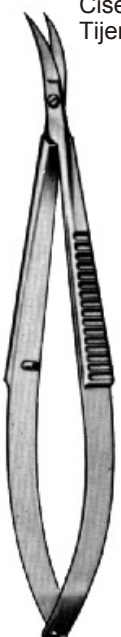

Castroviejo

35-7423
10,0 cm/4"



spitz
pointed
pointus
agudos



Castroviejo

35-7424
10,0 cm/4"



stumpf
blunt
mousses
romos

Iridektomiescheren
Iridectomy Scissors
Ciseaux à iridectomie
Tijeras para iridectomia

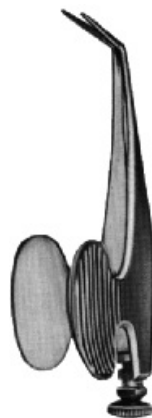

Barraquer

5,5 cm/2¼"



Fig. 1
35-7425



Fig. 2
35-7426



Fig. 3
35-7427



Fig. 4
35-7428



Fig. 5
35-7429



Fig. 6
35-7430

fein
delicate
fins
finos





Reill



35-7432-01
 14,0 cm/5½"
 gerade
 straight
 droits
 rectas



35-7432-02
 15,5 cm/6¼"
 gebogen
 curved
 courbes
 curvas



35-7432-03
 15,5 cm/6¼"
 gebogen
 curved
 courbes
 curvas

1 Schneide gezahnt
 1 blade saw edge
 1 lame dentelée
 1 hoja dentada



Vannas
 16,0 cm/6¼"



35-7433-01
 gerade
 straight
 droits
 rectas



35-7433-02
 gebogen
 curved
 courbes
 curvas



10,0 cm/4"



35-7434-01
 gerade
 straight
 droits
 rectas



35-7434-02
 gebogen
 curved
 courbes
 curvas

sehr fein
 very delicate
 très fins
 muy finos

spitz / spitz
 sharp / sharp
 pointus / pointus
 agudas / agudas



kantige Ausführung
square shanks
modèle anguleux
modelo anguloso

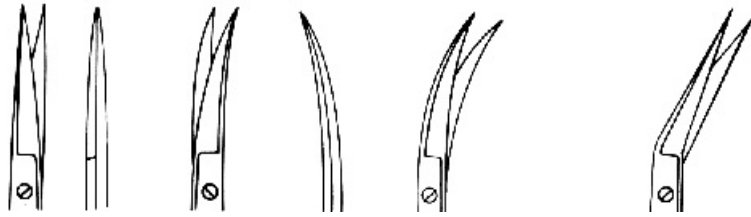

	gerade straight droits rectas	gebogen curved courbes curvas	seitwärts gebogen curved sideways courbe à la côté curva lateral	seitwärts abgewinkelt angular on side coudé à la côté acodada lateral
9,0 cm/3½"	35-7450	35-7451	35-7452	35-7453
10,5 cm/4¼"	35-7454	35-7455	35-7456	35-7457
11,5 cm/4¾"	35-7458	35-7459	35-7460	35-7461



runde Ausführung
round shanks
modèle rond
modelo redondo



	gerade straight droits rectas	gebogen curved courbes curvas	seitwärts gebogen curved sideways courbe à la côté curva lateral	seitwärts abgewinkelt angular on side coudé à la côté acodada lateral
9,0 cm/3½"	35-7470	35-7471	35-7472	35-7473
10,5 cm/4¼"	35-7474	35-7475	35-7476	35-7477
11,5 cm/4¾"	35-7478	35-7479	35-7480	35-7481





Irisschere
Iris Scissors
Ciseaux pour l'iris
Tijeras para iris

Graefe

35-7483
10,5 cm/4¼"



Augenschere
Eye Scissors
Ciseaux oculaires
Tijeras oculares

Le Grange

35-7485
10,5 cm/4¼"

Sehnenscheren, Tenotomy Scissors, Ciseaux à ténotomie, Tijeras para tenotomía

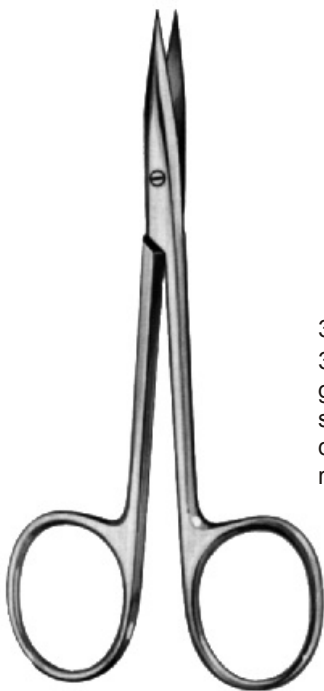

Stevens
spitz
pointed
pointus
agudas



35-7490 10,0 cm/4"
35-7492 11,0 cm/4½"
gerade
straight
droits
rectas



35-7491
35-7493
gebogen
curved
courbes
curvas



Stevens
stumpf
blunt
mousses
romas



35-7494 10,0 cm/4"
35-7496 11,0 cm/4½"
gerade
straight
droits
rectas

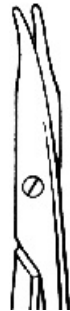

35-7495
35-7497
gebogen
curved
courbes
curvas



spitz
 pointed
 pointus
 agudas

35-7500
 35-7501
 gerade
 straight
 droits
 rectas

9,0 cm/3½"
 10,5 cm/4¼"



35-7502
 35-7503
 gebogen
 curved
 courbes
 curvas



spitz
 pointed
 pointus
 agudas

35-7504
 gerade
 straight
 droits
 rectas

9,5 cm/3¾"



35-7505
 gebogen
 curved
 courbes
 curvas



A	
Abdominal Retractors	265-275
Abdominal Spatulas	276,277
Adenoid Curettes	473
Adenotomes	474
Adlerkreutz Tissue Forceps	30
Adson Bone Rongeur Forceps	339
Adson Brown Tissue Forceps	31
Adson Dressing Forceps	26
Adson Drill Guider and Dura Protecting Forceps	281
Adson Forceps With TC Jaws	166
Adson Hand Bone Twist Drills Extension Piece	286
Adson Hemostatic Forceps	53
Adson Needle Holders	186
Adson Nerve Hooks	122
Adson Periosteal Raspatories	311
Adson Retractors	262,263
Adson Suction Tubes	215
Adson Tissue Forceps	30
Adson-Baby Retractors	261
Adson-Tonnis Dissecting Scissors	151
Alan Parks Anal Retractors	94
Alexander Biopsy Punches	432
Alexander Bone Chisels	292
Alexander Gouges	292
Alexander Periosteal Raspatories	308
Allis Tissue Grasping Forceps	379,380
Allis Tissue Seizing Forceps With TC Jaws	175
Allis-Adair Tissue Grasping Forceps	379
Allis-Baby Tissue Grasping Forceps	379
Allison Lung Spatulas	359
Alm Eye Specula	511
Aluminium Tuning Forks	20
Amputating Knives	83
Amputating Saws	279,280
Anal Retractors	93,94
Analpreizer Rectal Speculums	93
Anastomosis Clamp Forceps	382
Anderson-Adson Retractors	264
Andrew Tongue Depressors	480
Anestophone Stethoscopes	8
Anusscopes	90-92
Arruga Capsular Forceps	497
Arruga Eye Needle Holders	187
Arruga Needle Holder With TC Jaws	167
Arthur Splinter Forceps	44
Asch Septum Forceps	452
Atrauma Forceps	35
Aufricht Hooks for Posterior Snares	469
Aufricht Nasal Rasps	468
Autopsy Knives	86
Auvarad Vaginal Specula	411
Ayer Chalazion Forceps	500
B	
Babcock Intestinal Forceps	380
Babcock Tissue Grasping Forceps	380
Babcock Tissue Seizing Forceps, TC Jaws	175
Babinsky Percussion Hammers	3
Baby Crile Hemostatic Forceps	52
Baby-Adson Hemostatic Forceps	53
Baby-Collin Abdominal Retractors	266
Baby-Duplex Stethoscopes	7
Baby-Kern Bone Holding Forceps	329
Baby-Lexer Dissecting Scissors	143
Baby-Olsen-Hegar Needle Holder TC Jaws	174
Baby-Olsen-Hegar Needle Holders	184
Baby-Roux Retractors	257
Baby-Satinsky Blood Vessel Clamps	362
Baby-Senn-Miller Retractors	255
Baby-Tischler Biopsy Punches	425
Backhaus Towel Forceps	62
Baggish Biopsy Punches	426
Bailey Rib Contractors	359
Bailey-Baby Rib Contractors	359
Bailey-Gibbon Rib Contractors	359
Bainbridge Hemostatic Forceps	50
Bakes Bile Duct Dilators	390
Balfour Abdominal Retractors	268,269
Balfour-Baby Abdominal Retractors	268
Ballenger Swivel Knives	471
Ballenger-Hajek Septum Elevators	462
Bamhill Adenoid Curettes	473
Bandage Scissors	159,160
Bane (Hartmann) Bone Rongeur Forceps	338
Barr Rectal Speculum	93
Barraquer Cilia Forceps	501
Barraquer Eye Needle Holders	187
Barraquer Fixation Forceps	498

Barraquer Iridectomy Scisso	
Barraquer Needle Holder Wi	
Barth Ear Curettes	
Baumgartner Needle Holder With TC Jaws	170
Beaupré Cilia Forceps	501
Beckmann Adenoid Curettes	473
Beckmann Retractors	262
Beckmann-Adson Retractors	264
Beckmann-Eaton Retractors	264
Beer Cilia Forceps	41
Bellucci Ear Polypus Forceps	491
Bengolea Hemostatic Forceps	56
Bennett Bone Levers	320
Bensaude Anusscopes	91
Benson Pylorus spreader	381
Berger Biopsy Punches	431
Bergmann Bandage Scissors	160
Bergmann Mallets	324
Berliner Percussion Hammers	3
Bernhard Towel Forceps	63
Bethune Rib Shears	348
Beyer Bone Rongeur Forceps	334,338
Bile Duct Dilators	390
Billeau Ear Loops	487
Biopsy Curettes	433,434
Biopsy Forceps	447,448
Biopsy Punches	425-432
Bircher Menisectomy Knives	316
Bircher-Ganske Cartilage Seizing Forceps	327
Bishop-Harmon Iris Forceps	496
Bladder Retractors	396,397
Blake Gall Stone Forceps	389
Blake Uterine Curettes	438
Blohmke Tonsil Seizing Forceps	482
Blood Pressure Manometers	9,10
Blood vessel Clamps	361,362
Blount Bone Levers	321
Blount Meniscus Retractors	321
Blumenthal Bone Rongeur Forceps	337
Bohler Bone Cutting Forceps	343
Bohler Bone Rongeur Forceps	339
Bohler Extension Bows	283
Bonaccolto Strabismus Forceps	499
Bone Chisels	291-299
Bone Curettes	300-305
Bone Cutting Forceps	342-344
Bone Drills	281
Bone Files	314,315
Bone Holding Clamps	345
Bone Holding Forceps	326-333
Bone Levers	317-321
Bone Rongeur Forceps	334-341
Bone Shears	347,349
Bonney Tissue Forceps	33
Bose Trachea Retractors	364
Bottcher Tonsil Scissors	152
Bowman Eye Specula	511
Bowman Lachrymal Probes	502
Boys-Allis Tissue Grasping Forceps	379
Bozemann Cotton Swab Forceps	67
Bozemann Needle Holder With TC Jaws	174
Bozemann-Douglas Cotton Swab Forceps	67
Brain Knives	85
Brain Spatulas	109
Brand Tendon Seizing Instruments	313
Braun Tenaculum Forceps	419
Braun Uterine Depressors	418
Braun-Steadler Perineum Scissors	147
Breisky Vaginal Specula	408
Brochus Clamps	361
Bronchial Scissors	151
Brophy Dressing Forceps	28
Brophy Tissue Forceps	32
Brown Needle Holders	182
Bruenings Ear Specula	15
Bruenings Tongue Depressors	480
Bruenings Tonsil Snares	483
Brunner Ligature Conductors	204
Brunner Retractors	251,252
Brunner Rib Shears	348
Brunner-Ferrozell Ligature Conductors	206
Bruns Bandage Scissors	160
Bruns Bone Curettes	300,301
Buchwald Tongue Depressors	480
Buck Ear Curettes	486
Buck Foreign Body Levers	493
Buck Percussion Hammers	4
Buelau Trocars	211

Buie Rectal Aspiration Cannulas	100
Bulldog Clamps	46
Bumm Uterine Curettes	437
Bunge Exenteration Scoops	509
Bunnell Hand Bone Drills	284
Bunnell Tendon Passing Instruments	313
Bunnell Tendon Stripper	313
Burford Rib Spreaders from Aluminium	351
Burke Biopsy Punches	426
Busch Umbilical Scissors	148
C	
Caliper Measuring Instruments	6
Cannulas	217
Caplan Nasal Scissors	451
Capsular Forceps	497
Capsule Forceps	400
Cardiophone Stethoscopes	8
caroll Measuring Instruments	5
Caroll Tendon Seizing Instruments	313
Carpenter Tonsil Knives and Enuclators	484
Caspar Exploration/Coagulation Hooks	110
Caspar Laminectomy Rongeurs	124
Castaneda Rib Spreaders from Aluminium	353
Castroviejo Corneal Scissors	514,516,517
Castroviejo Eye Needle Holders	187
Castroviejo Eye Specula	511
Castroviejo Marker graduated	512
Castroviejo Needle Holder With TC Jaws	167
Castroviejo Suture Forceps	498-500
Cataract Needle	506
Catheter Introducing Forceps	219
Catlin Amputating Knives	83
Cervical Traction Tongs	105
Chalazion Curettes	509
Charriere Amputating and Resection Saws	279
Cheatle Sterilizing Forceps	69
Cheisea Eaton Anoscopes	91
Cheron Cotton Swab Forceps	68
Chevalier-Jackson Trachea Tubes	366
Chir.Pinzette Forceps With TC Jaws	166
Chisels	466
Cilia Forceps	41,501
Cinelli Nasal Osteotomes	465
Circumcision Instruments	398
Clamp Closing Forceps	383
Clamp Forceps	60,61
Clamp Holders	383
Clar Head Lamps	11
Cleveland Bone Cutting Forceps	343
Cleveland Bone Rongeur Forceps	336
Clip Applying Forceps	107,108
Clips	107
Cloward Intervertebral Disc Rongeurs	123
Cloward Lamina Spreaders	106
Cloward Laminectomy Spreaders	133
Coakley Trocars	213
Colclough (Richter) Disc Rongeurs	129,130
Cold Light source and accessories	102
Collier Needle Holders	182
Collin Abdominal Retractors	266
Collin Clip Applying Forceps	195
Collin Cotton Swab Forceps	68
Collin Lung Grasping Forceps	360
Collin Mallets	322
Collin Measuring Instruments	5
Collin Operating Knives	78
Collin Pelvimeters	440
Collin Retractors	256
Collin Tongue Holding Forceps	481
Collin Uterine Elevating Forceps	423
Collin Vaginal Specula	405
Collin-Loktite Abdominal Retractors	265,266
Comedo Extractors	74
Comprimeter	14
Cone Retractors	261
Converse Hooks for Posterior Snares	469
Converse Rhinoplastic and Nasal Knives	472
Cooley Rib Spreaders	356
Cooley Rib Spreaders from Aluminium	352
Coopelson Biopsy Punches	425
Cooper Ligature Needles	202
Corneal Scissors	514,516,517
Coryllos Retractors	249
Cottle Hooks for Posterior Snares	469,471
Cottle Mallets	323
Cottle Nasal and Ear Dressing Forceps	458
Cottle Nasal Osteotomes	464
Cottle Nasal Rasps	468

Cottle Nasal Specula	
Cottle Rhinoplastic and Nasal	
Cottle Septum and Periosteal	
Cottle-Neivert Hooks for Posterior nares	470
Cotton Applicators	101,225
Cotton Swab Forceps	66-68
Cover Glass Forceps	42
Crafoord Hemostatic Forceps	55
Crafoord Lobectomy Scissors	149
Cranial Opening Instruments	104
Crile Hemostatic Forceps	51
Crile Needle Holders	186
Crile Nerve Hooks	121
Crile Retractors	231
Crile-Rankin Hemostatic Forceps	51
Crile-Wood Needle Holder With TC Jaws	170
Crile-Wood Needle Holders	182,184
Crutchfield Cervical Traction Tong	105
Cuching Hand Bone Twist Drills Extensional	286
Cusco Vaginal Specula	404
Cushing Brain Spatulas	109
Cushing Decompression hook	232
Cushing Dressing Forceps	28
Cushing Dura Hooks	122
Cushing Forceps With TC Jaws	166
Cushing Intervertebral Disc Rongeurs	126
Cushing Nerve Hooks	121
Cushing Retractors	230
Cushing Tissue Forceps	32
Cuticle Instruments	136
Cuticle Nippers	136
Czemy Rectal Specula	95
Czerny Tenaculum Forceps	420

D	
Dahlgren Scull-Cutting Forceps	104
Dandy Crile Hemostatic Forceps	52
Dandy Dissecting Scissors	151
Dandy Nerve Hooks	121
Darmschere Enterotomy Scissors	154
Dartigues Uterine Elevating Forceps	423
Dastoor Erisophakes	497
Daubenspeck Bone Curettes	303
Davidson Retractors	250
Davis Dura Dissectors	118
Davis Sterilizing Forceps	69
Davis-Boyle Mouth Gags	476,478
De Bakey Abdominal Retractors	274
De Bakey Atrauma Forceps	35
De Bakey Needle Holder With TC Jaws	170
De Bakey Suction Tubes	218
De La Roza Ligature Needles	203
De Martel-Wolfson Anastomosis Clamp Forceps	382
De Martel-Wolfson Clamp Closing Forceps	383
De Martel-Wolfson Clamp Holders	383
De Vilbiss Scull-Cutting Forceps	104
Dean Tonsil Scissors	152
Deaver Operating Scissors	141
Deaver Retractors	246,247
Dejerine Percussion Hammers	4
Denhart Mouth Gags	475
Denis-Browne Abdominal Retractors	271
Derf Needle Holder With TC Jaws	168
Derf Needle Holders	182
Dermal Punches	71
Dermatomes	72
Deschamps Ligature Needles	197-201
Desjardins Gall Stone Forceps	389
Desjardins Gall Stone Probes	390
Desjardins Gall Stone Scoops	392
Desmarres Chalazion Forceps	500
Desmarres Corneal Knives	504
Desmarres Lid Retractor	512
Dieffenbach Bulldog Clamps	46
Dieffenbach Operating Knives	78
Dilating Bougies	394,395
Dingmann Cartilage Seizing Forceps	326
Diplomat Presameter	9
Directors	100,223,224
Dissecting Forceps	57
Dissecting Scissors	142-145,150,154
Dissectors	484
Dittel Dilating Bougies	395
Dix Needle and Chisel	506
Dix Needle and Gouge	506
Douglas Cilia Forceps	41
Doyen Dissecting Scissors	143
Doyen Intestinal Clamp Forceps	381,384
Doyen Mallets	322

Doyen Myoma Screw	423
Doyen Periosteal Raspatories	308
Doyen Retractors	243
Doyen Tongue Depressors	480
Doyen Towel Forceps	62
Doyen Uterine Elevating Forceps	422
Doyen Vaginal Specula	408,409
Doyen-Stille Retractors	241
Dressing Forceps	25-28,66,67,459
Dressing Forceps Delicate	36
Dressing Forceps With TC Jaws	165
Dubois Cephalotomy Scissors	147
Duplay Polypus and Dressing Forceps	67
Duplay Tenaculum Forceps	419
Duplex Stethoscopes	7
Dura Dissectors	116-118
Dura Hooks	122
Duval Lung Grasping Forceps	360
Duval Tissue Seizing Forceps With TC Jaws	175
E	
Ear Currettes	486,487
Ear Hooks	488
Ear Loops	487
Ear Polypus Forceps	490,491
Ear Specula	15
Echlin Bone Rongeur Forceps	340
Eder Cotton Applicators	101
Elevators	312
Elliot Obstetrical Forceps	441
Elschnig Iris Forceps	495
Emmett Laser Instruments	414
Empire Blood Pressure Manometers	9
Endarterectomy Strippers	226
Endospecula	412,413
Engel Plaster Cast Instrument	162
engl-Mod Dressing Forceps	26
Enterotomy Scissors	154
Entropium Forceps	501
Enucleators	484
Eppendorf Biopsy Punches	429
Errico Hand Bone Twist Drills Extension Piece	286
Esmarch Bandage Scissors	159
Esmarch Plaster-of-Paris Knives	161
Eves Tonsil Snares	483
Examination and Measuring Instruments	5,6
Xenteration Scoops	509
Exploration/Coagulation Hooks	110
Extension Bows	283
Eye Hooks	507
Eye Knives	503,504
Eye Needle Holders with TC Jaws	167
Eye Scissors	520
Eye Specula	510,511
F	
Farabeuf Bone Holding Forceps	328
Farabeuf Periosteal Raspatories	306
Farabeuf Retractors	256
Farabeuf-Lambotte Bone Holding Forceps	328
Farrell Cotton Applicators	225
Faulkner Septum Elevators	462
Faure Clamp Forceps	61
Feilchenfeld Splinter Forceps	39
Feldmann Tourniquet	138
Ferguson Needles	194
Fergusson Bone Holding Forceps	328
Fergusson Suction Tubes	216
Ferris-Smith-Kerrison Rongeurs	127,128
Fine Swiss Tweezers	24
Finger nail Drill Set	138
Finger Ring Saw Blades	138
Finger Ring Saws	138
Finocchietto Rib Spreaders	354
Finocchietto Rib Spreaders from Aluminium	350
Finocchietto-Baby Rib Spreaders	354
Finocchietto-Baby-Haight Rib Spreaders of Al	350
Finocchietto-Burford Rib Spreaders	355
Finocchietto-Infant Rib Spreaders of Aluminium	350
Finocchietto Needle Holder With TC Jaws	170
Finocchietto Needle Holders	185
Finsen Retractors	258
Fisch Micro Hooks	112
Fischer Iris Forceps	495
Fixation Forceps	498
Flat Nose Pliers	288,289
Foerster Sponge Holding Forceps	68
Fomon Hooks for Posterior Snares	469,470
Fomon Nasal Osteotomes	465
Fomon Nasal Rasps	468

Fomon Rhinoplastic and Nasal Forceps with TC Jaws	
Foregger Laryngoscopes	
Foregger Laryngoscopes, cold light	376
Foreign Body Forceps	398
Foreign Body Instruments	506,507
Foreign Body Levers	493
Foreign Body Needle	506
Foreign Body Remover and Magnetic Eye Probe	506
Fox Lupus Currettes	73
Frankenfeld Rectal Snare	100
Frankfeldt Cotton Applicators	101
Franz Abdominal Retractors	270
Frazier Abdominal Retractors	275
Frazier Dura Dissectors	118
Frazier Dura Hooks	122
Frazier Suction Tubes	215,216
Freer Chisels	466
Freer Hooks for Posterior Snares	470
Freer Septum Elevators	462
Freer Septum Gouges	466
French Needle Holder With TC Jaws	168
French Tuning Forks	18
French-Mathieu Needle Holder With TC Jaws	172
Fritsch Retractors	242
Frontal Wire Cutter Pliers	290
G	
Galea Hooks	115
Gall Stone Forceps	389
Gall Stone Probes	390
Gall Stone Scoops	391,392
Gallaher Bone Files	314
Gelpi-Loktite Abdominal Retractors	274
Gemini Dissecting Forceps	57
Gerald Dressing Forceps	27
Gerald Tissue Forceps	31
Gerster Bone Holding Clamps	345
Giertz-Stille Rib Shears	348
Gigli Saw Handle	104
Gigli Saw Three-fold	104
Gill Iris Forceps	495
Gill-Arruga Capsular Forceps	497
Gill-Hess Iris Forceps	495
Gillies Hooklets	73
Gillies Needle Holder With TC Jaws	174
Gillies Needle Holders	183
Gillies Tissue Forceps	31
Gillies-Baby Needle Holder With TC Jaws	174
Gluck Rib Shears	347
Goldmann-Fox Operating Scissors	141
Goldstein Eye Specula	510
Good Tonsil Scissors	152
Gosset Abdominal Retractors	267
Gouges	291-299
Gradle Cilia Forceps	501
Graefe Cataract Knife and Chisel	507
Graefe Cataract Knives	504
Graefe Eye Hooks	507
Graefe Fixation Forceps	498
Graefe Iris Forceps	495
Graefe Iris Scissors	520
Graefe Needle and Chisel	507
Graefe Needle and Gouge	507
Graefe Strabismus Hooks	508
Graham Dura Hooks	122
Graig Nasal Septum Forceps	459
Grasping Forceps	424
Grave Vaginal Specula	404,406
Grazil Operating Scissors	140
Green Fixation Forceps	498
Green Tubing Clamps	64
Green-Armytage Uterine Hemostasis Forceps	443
Gross Dressing Forceps	66
Grunwald-Jansen Nasal, Ear Dressing Forceps	458
Guide Needles	214
Guthrie Eye Hooks	507
Guyon Catheter Introducing Instrument	393
Guyon Dilating Bougies	394
Gynecological Scissors	146
H	
Haberer Abdominal and Intestinal Spatulas	276
Haemorrhoidal Forceps	89
Haemorrhoidal Ligators	88,89
Haglund-Stille Plaster Cast Instrument	163
Haight Rib Spreaders	355
Hajek Mallets	323
Hajek Sphenoid Punches	461
Halle Bone Currettes	304

Halle Dura Hooks	122
Halogen-Light for Cold Light Handles	377
Halsey Needle Holder With TC Jaws	171
Halsey Needle Holders	182
Halsted-Mosquito Hemostatic Forceps	47
Hand Bone Drills	284-287
Handles for Rectal Biopsy Specimen Forceps	99
Hank Uterine-Dilators	418
Harken Blood Vessel Clamps	362
Harken Rib Spreaders	358
Harrington Retractors	247
Hartmann Ear Polypus Forceps	490
Hartmann Ear Specula	15
Hartmann Hemostatic Forceps	46
Hartmann Nasal Polypus Forceps	457
Hartmann Nasal Specula	453
Hartmann Tuning Forks	16
Hartmann-Halle Nasal Specula	453
Hartmann-Noyes Ear Polypus Forceps	490
Hartmann-Weingartner Ear Polypus Forceps	490
Hartmann-Wullstein Ear Polypus Forceps	490
Head Lamps	11
Heaney Clamp Forceps	60
Heaney Needle Holder With TC Jaws	171
Heaney Needle Holders	185
Heaney-Ballentine Clamp Forceps	60
Heath Wire Cutting Scissors	153
Hegar Needle Holder With TC Jaws	169
Hegar Uterine-Dilators	415-417
Hegar-Baumgartner Needle Holders	183
Hegenbarth Clip Applying Forceps	195
Heifetz Brain Spatulas	109
Heifetz Tumor Forceps	40
Heiss Hemostatic Forceps	54
Heister Mouth Gags	475
Helferich-Bier Amputating and Resection Saws	280
Hemostatic Forceps	46-56,58,59
Henke Tonsil Dissectors	484
Henning Plaster Cast Instrument	162
Hess Iris Forceps	496
Hessberg Ligature Needles	203
Heymann Nasal Scissors	152
Heymann-Knight Nasal Polypus Forceps	457
Hibbs Bone Chisels	298
Hibbs Gouges	299
Hibbs Osteotomes	298,299
Hirschmann Anusscopes	90
Hoen Dura Dissectors	118
Hohmann Bone Levers	318,319
Hoizbach Abdominal Retractors	265
Holscher Nerve Root Retractors	120
Holtzheimer Retractors	258
Hook Osteotomes	298
Hooklets	73
Hooks for Posterior Snares	469-471
Hopkins Plaster-of-Paris Knives	161
Horsley Dura Dissectors	119
Hosel Retractors	244
Howarth Periosteal Raspatories	307
Hudson Hand Bone Drills	286
Hudson Hand Bone Twist Drills Extension Piece	286
Hunter Splinter Forceps	39
Hurd Tonsil Dissectors and Retractors	484
Hylli Periosteal Raspatories	309
Hysterectomy Forceps	60,61
Hystero-Salpingography Instruments	13
I	
Inge Lamina Spreaders	106
Intervertebral Disc Rongeurs	123,125-130
Intestinal Clamp Forceps	381,382,384-386
Intestinal Forceps	379,380
Intestinal Needles	192
Intestinal Spatulas	276,277
Iowa Cannulas	217
Iridectomy Scissors	514-517
Iris Forceps	495,496
Iris Hook	414
Iris Scissors	519,520
Iris Scissors "Ribbon type"	521
Irisschere Scissors with TC edges	178
Irisschere Supercut Scissors	157
Israel Retractors	236
Itersen Trachea Retractors	364
Ives-Fansler Anusscopes	92
J	
Jackson Trachea Retractors	365
Jacobs Three-Jaw Chuck	284
Jaeger Eye Hooks	507

Jaeger Keratomes	
Jaeger-Grieshaber Keratom	
Jakobs Tenaculum Forceps	
Jakobson Buttoned Probe	113
Jakobson Micro Vessel Knives	114
Jakobson Twin Probe	113
Janet Syringes	221
Jansen Bone Rongeur Forceps	337
Jansen Ear Curettes	487
Jansen Nasal and Ear Dressing Forceps	458
Jansen Periosteal Raspatories	309
Jansen Retractors	258
Jennings Mouth Gags	475
Jess Fixation Forceps	498
Jobson-Horne Cotton Applicators	225
John Hopkins Bulldog Clamps	46
Jones Towel Forceps	62
Joseph Bone Files	314
Joseph Delicate Operating Scissors	148
Joseph Hooks for Posterior Snares	469,470
Joseph Nasal Saws	467
Joseph Periosteal Raspatories	312
Joseph Rhinoplastic and Nasal Knives	472
Joseph Septum and Periosteal Elevators	463
Joseph-Masing Septum Elevators	462
Judd-Allis Tissue Grasping Forceps	379
Judd-Masson Bladder Retractors	397
K	
Kader Abdominal and Intestinal Spatulas	277
Kallmorgen Retractors	407
Kallmorgen Vaginal Specula	407
Kalt Eye Needle Holders	187
Kalt Needle Holder With TC Jaws	167
Kantrowitz Hemostatic Forceps	59
Katzin Corneal Scissors	514
Keith Muscular, Skin Sutures	190
Kelly Delicate Scissors	146
Kelly Hemostatic Forceps	51
Kelly Protoscopes	92
Kelly Retractors	239,255
Kelly Sphincteroscopes	92
Kelly Uterine Polypus Forceps	422
Kelly-Rankin Hemostatic Forceps	51
Keratomes	505
Kern Bone Holding Forceps	330
Kerrison Antrum Punch Forceps	461
Kevoorkian Biopsy Curettes	433,434
Kevoorkian Biopsy Punches	425,429
Kevoorkian-Young Biopsy Curettes	434
Key Periosteal Raspatories	308
Keyes Dermal Punches	71
Keyes Set Dermal Punches	71
Kidney Stone Forceps	388
Kielland Obstetrical Forceps	441
Kielland-Luikart Obstetrical Forceps	441
Killian Nasal Forceps	459
Killian Nasal Scissors	451
Killian Nasal Specula	455
Killian Septum and Periosteal Elevators	463
Killian Septum Elevators	462
Killian Septum Gouges	466
Killian-Claus Septum Gouges	466
Kilner Dissecting Scissors	148
Kilner Hooklets	73
Kilner Hooks for Posterior Snares	469
Kilner-Doughty Mouth Gags	479
Kirschner Abdominal Retractors	271
Kirschner Extension Bows	283
Kirschner(Amerikanische Mod.) Extension Bows	283
Klapp Tendon Sheath Retractors	231
Klima-Rosegger Cannulas	217
Knapp Discission Knives	504
Knapp-Clark Eye Specula	510
Knight Septum Froceps	459
Knowles Bandage Scissors	159
Kocher Bladder Retractors	396
Kocher Hemostatic Forceps	49
Kocher Intestinal Clamp Forceps	382,386
Kocher Ligature Conductors	206
Kocher Retractors	234,237,240,243
Kocher-Wagner Retractors	254
Koenig Tuning Forks	19
Koerte Abdominal and Intestinal Spatulas	277
Koerte Retractors	235
Kogan Endospecula	412,413
Konig Ligature Conductors	205
Koos Micro Vessel Knives	114
Kraus Micro Vessel Knives	114

Krause Nasal Polypus Snare	456
Krause Trocars	213
Krause-Voss Nasal Polypus Snare	456
Krayenbuhl Nerve and Vessel Hooks	111
Kristeller Retractors	402,403
Kristeller Vaginal Specula	402,403
Kronecker Ligature Needles	202
Kuehne cover Glass Forceps	42
Kuempel Abdominal and Intestinal Spatulas	277
Kuhnt Cataract Knives	504
L	
La Force Adenotomes	474
Laborde Trachea Dilators	364
Lachrymal Dilators	508
Lachrymal Probes	502
Lahey Goitre Grasping Forceps	366
Lahey Hemostatic Forceps	59
Lahey Retractors	239
Lambotte Bone Holding Forceps	331
Lambotte Osteotomes	293
Lambotte Periosteal Raspatories	307
Lamina Spreaders	106
Laminectomy Rongeurs	124
Laminectomy Spreaders	131-133
Lancaster Eye Specula	511
Landau Trocars	212
Lane Bone Holding Forceps	330
Lane Bone Levers	320
Lane Screw Drivers	282
Lane Tissue Forceps	33
Lane Towel Forceps	63
Lange-Hohmann Bone Levers	320
Lange-Hohmann modif Bone Levers	320
Langenbeck Amputating and Resection Saws	279
Langenbeck Amputating Knives	83
Langenbeck Bone Holding Forceps	328
Langenbeck Elevators	312
Langenbeck Periosteal Raspatories	306
Langenbeck Resection Knives	84
Langenbeck Retractors	237,238
Langenbeck-Kocher Retractors	237
Larry Rectal Director	100
Laryngeal Mirrors	2
Laryngoscope Handle, Transformer Connection	372,377
Laryngoscope Handles	372
Laryngoscope Handles, cold light	377
Laryngoscopes	368-371
Laryngoscopes , cold light	373-376
Laser Hook	414
Laser Instruments	414
Lateral Vaginal Retractor	410
Lateral Wire Cutter Pliers	290
Laufe Haemorrhoidal Forceps	89
Le Grange Eye Scissors	520
Lead Hands	321
Lebsche Sternum Scissors	349
Legue Bladder Retractors	396
Legueu Bladder Retractors	397
Leksell-Stille Bone Rongeur Forceps	335
Lempert Bone Curettes	304
Lempert Bone Rongeur Forceps	334
Lengenbeck Ear Curettes	487
Leriche Hemostatic Forceps	53
Lewin Bone Holding Forceps	326
Lexer Bone Chisels	296
Lexer Gouges	297
Lexer Osteotomes	297
Lichtwitz Trocars	212
Lid Retractor	512
Ligature Forceps	57
Ligature Guides	111
Ligature Scissors	153
Ligaturschere Scissors	153
Lister Bandage Scissors	159
Lister Scissors with TC edges	176
Lister Sinus Forceps	66
Lister Supercut Scissors	157
Lister-Burch Eye Specula	511
Lister-Excentric Bandage Scissors	160
Liston Amputating Knives	83
Liston Bone Cutting Forceps	342
Liston-Key Bone Cutting Forceps	342
Liston-Mini Bone Cutting Forceps	342
Littauer Cilia Forceps	41
Littauer Ligature Scissors	153
Littauer Nasal Polypus Forceps	457
Lockhart-Mummery Fistula Probes	224
Lockwood-Allis Tissue Grasping Forceps	380

Lorenz Bandage Scissors	
Lorna Towel Forceps	
Love Nerve Root Retractors	
Love-Gruenwald Intervertebral Disc Rongeurs	126
Lovelace Hemostatic Forceps	52
Lovelace Lung Grasping Forceps	360
Lowmann Bone Holding Clamps	345
Lowmann-Baby Bone Holding Clamps	345
Lowmann-Hoglund Bone Holding Clamps	345
Luc Ethmoid Forceps	459
Lucae Ear Hooks	488
Lucae Mallets	322
Lucae Nasal and Ear Dressing Forceps	458
Lucae Paracentesis Needles	489
Lucae Tuning Forks	17
Lucas Bone Chisels	293
Lucas Gouges	293
Luer Bone Rongeur Forceps	334,336
Luer Lock Cannulas	217
Luer Lock Syringes	220
Luer Syringes	220
Luer Trachea Retractors	365
Luer-Friedmann Bone Rongeur Forceps	336
Luer-Koerte Gall Stone Scoops	391
Luer-Lock joint Syringe	221
Lukens Trachea Retractors	365
Lung grasping Forceps	34,360
Lung Spatulas	359
Lupus Curettes	73
M	
M.G.H Needle Holders	183
Magill Catheter Introducing Forceps	219
Magill-Baby Catheter Introducing Forceps	219
Maier Polypus and Dressing Forceps	67
Mallets	322-325
Mallets of Solid Brass	322
Mallets of Solid Ferrozell	325
Mallets of Solid Steel	325
Mallets with Lead Filled	322
Mallets without Lead	324
Maltz Nasal Rasps	468
Marker Graduated	512
Markham-Meyering Abdominal Retractors	273
Marquardt Bone Rongeur Forceps	341
Martel Conductor for wire saws	104
Martin Pelvimeters	440
Martin Retractors	248
Martin Uterine Sounds	418
Martini Bone Curettes	302
Masing Septum and Periosteal Elevators	463
Masson Needle Holder With TC Jaws	173
Masson Needle Holders	185
Mathieu Foreign Body Forceps	398
Mathieu Needle Holder With TC Jaws	171,172
Mathieu Needle Holders	186
Mathieu Retractors	256,409
Mathieu Vaginal Specula	409
Matson Periosteal Raspatories	308
Maxi Grasping Forceps	424
Mayfield Bone Rongeur Forceps	341
Mayo Dissecting Scissors	142
Mayo Gall Stone Probes	390
Mayo Gall Stone Scoops	392
Mayo Needles	194
Mayo Scissors with TC edges	177
Mayo Supercut Scissors	155
Mayo-Blake Gall Stone Forceps	389
Mayo-Harrington Dissecting Scissors	142
Mayo-Hegar Needle Holder With TC Jaws	168
Mayo-Hegar Needle Holders	183
Mayo-Lexer Dissecting Scissors	143
Mayo-Lexer Scissors with TC edges	177
Mayo-Lexer Supercut Scissors	155
Mayo-Noble Dissecting Scissors	142
Mayo-Robson Intestinal Clamp Forceps	381,385
Mayo-Stille Dissecting Scissors	142
Mayo-Stille Scissors with TC edges	177
Mayo-Stille Supercut Scissors	155
Mc Clure Micro Scissors	513
Mc Guire Corneal Scissors	514
Mc Indoe Bone Cutting Forceps	343
Mc Indoe Cartilage Scissors	150
Mc Indoe Dressing Forceps	26
Mc Ivor Mouth Gags	477
Mc Kenzie Brain Clip Carrier	107
Mc Kenzie Clip Applying Forceps	108
Mc Kenzie Silver Wire in coils	107
Mc Lean-Tucker Obstetrical Forceps	441

McDonald Elevators	312
McGivney Haemorrhoidal Forceps	89
McIntosh Laryngoscopes	368,369
McIntosh Laryngoscopes, cold light	373
Mckenzie Hand Bone Twist Drills Extension Piece	286
McPherson Suture Forceps	497
Mead Bone Rongeur Forceps	338
Mead Mallets	323
Mellinger Eye Specula	510
Mellinger-Axenfeld Eye Specula	510
Mellinger-Beard Eye Specula	510
Menghini Cannulas	217
Meniscotomy Knives	316
Metal Catheters	393
Metal Rule Measuring Instruments	6
Metzenbaum (Strabismus) Dissecting Scissors	145
Metzenbaum (Strabismus) Scissors with TC edg	177
Metzenbaum (Strabismus) Supercut Scissors	157
Metzenbaum Dissecting Scissors	144
Metzenbaum Scissors with TC edges	178
Metzenbaum Supercut Scissors	156
Metzenbaum-Fino Dissecting Scissors	145
Metzenbaum-Fino Scissors with TC edges	178
Metzenbaum-Fino Supercut Scissors	157
Metzenbaum-Lahey Dissecting Scissors	145
Meyer Gouge for Foreign Bodies	506
Meyerding Abdominal Retractors	273
Meyerding Retractors	229,253
Meyerding-Scoville Laminectomy Blades	132
Meyhoefer Chalazion Curettes	509
Michel Clip Applying Forceps	195
Michel Suture Clips	196
Micro Ear Polypus Forceps	492
Micro Forks	113
Micro Hooks	112
Micro Raspatories	112,113
Micro Scissors	513,515,518
Micro Scoops	113
Micro Vessel Knives	114
Micro-Friedmann Bone Rongeur Forceps	336
Microscope Forceps	39
Middeldorpf Retractors	241,242
Middleton-Jansen Septum Forceps	460
Mikulicz Clamp Forceps	61
Mikulicz Retractors	251
Miller Laryngoscopes	370
Miller Laryngoscopes, cold light	374,375
Milligan Retractors	260
Millin Bladder Retractors	397
Millin Capsule Forceps	400
Mini-Friedmann Bone Rongeur Forceps	336
Mini-Gemini Dissecting Forceps	57
Mini-Hohmann Bone Levers	317
Mini-Lambotte Osteotomes	292
Mini-Langenbeck Retractors	231
Mini-Lexer Gouges	297
Mini-Lexer Osteotomes	297
Minimus III Blood Pressure Manometers	10
Mini-Roux Retractors	257
Mini-Tischler Biopsy Punches	425
Miscellaneous Ear Instruments	488
Mittelfein Ear Polypus Forceps	491
Mixer Gall Stone Forceps	389
Mixer Hemostatic Forceps	58
Mixer Hemostatic Forceps	59
Mixer Operating Scissors	141
Mixer-Baby Hemostatic Forceps	58
Mixer-O'Shaughnessy Hemostatic Forceps	58
Mock Cannulas	217
Mod. Bonn Iris Forceps	496
Mod. Muenchen Biopsy Curettes	434
Mod. Russ Lung Grasping Forceps	34
Mod.mayo-Russ Lung grasping Forceps	34
Modell Tubingen Retractors	248
Moeltgen Measuring Instruments	5
Mollison Retractors	261
Molt Mouth Gags	475
Moore Gall Stone Scoops	392
Moore Hand Bone Drills	284
Morgan Protoscopes	90
Morse Rib Spreaders	357
Morse Rib Spreaders from Aluminium	353
Morse-Favaloro Rib Spreaders	357
Mouth Gags	475-479
Moynihan Clamp Forceps	60
Mueller Eye Specula	510
Murdock Eye Specula	510
Murphy-Lane Bone Levers	320

Muscular, Skin Sutures	
Museux Tenaculum Forceps	
Myoma Screw	
N	
Nabatoff Varicose Vein Probe Set	226
Naegele Obstetrical Forceps	440
Nail File	135
Nail Instruments	135-138
Nail Nippers	136,137
Nail Scissors	137
Narath Ligature Needles	203
Nasal Cutting Forceps	445,446,449
Nasal Forceps	447,448,458,459
Nasal Knives	472
Nasal Osteotomes	464-466
Nasal Polypus Forceps	457
Nasal Polypus Snares	456
Nasal Rasps	468
Nasal Saws	467
Nasal Scissors	152
Nasal Scissors	450,451
Nasal Specula	453-455
Needle holders with TC jaws	168-174
Neff Meniscotomy Knives	316
Negus Hemostatic Forceps	58
Negus Mouth Gags	478
Neivert Hooks for Posterior nares	471
Nelson Lung Grasping Forceps	34
Nelson Trocars	211
Nerve and Vessel Hooks	111
Nerve Hooks	121,122
Nerve Root Retractors	119,120
Neurological Tuning Forks	19
Neurosurgical Scissors	151
News Trachea Retractors	365
Nicati Cataract Knives	504
Noto Uterine Polypus Forceps	422
Novak Biopsy Curettes	433
Novak-Schoeckaert Biopsy Curettes	434
Noyes Fixation Forceps	498
Noyes Iridectomy Scissors	514,516,517
Nurses Set	135
O	
Obstetrical Forceps	440,441
Obstetrics Scissors	147,148
Ochsner Trocars	211
Ochsner-Kocher Hemostatic Forceps	49
Oldberg Intervertebral Disc Rongeurs	125
Olivecrona Bone Rongeur Forceps	338
Olivecrona Brain Spatulas	109
Olivecrona Cranial Opening	104
Olivecrona Dura Dissectors	117
Olivecrona-Toennis Clip Applying Forceps	108
Ollier Retractors	235
Olsen-Hegar Needle Holder With TC Jaws	169,173
Olsen-Hegar Needle Holders	184
Ombredanne Mallets	324
Ombredanne Towel Forceps	63
Operating Knives	76-78
Operating Scissors	140,141,146
Operating Scissors with TC edges	176
Osteotomes	291
O'Sullivan-O'Connor Abdominal Retractors	272
Overholt-Geissendoerfer Hemos Forceps	54
Ovum Forceps	442
P	
Paracentesis Needles	489
Parametrium Scissors with TC edges	176
Parker Retractors	257
Parker-Langenbeck Retractors	256
Park-Guyton Eye Specula	510
Partsch Bone Chisels	291
Partsch Gouges	291
Partsch Mallets	323
Payr Intestinal and Stomach Clamp	383
Payr Ligature Conductors	206
Pean Hemostatic Forceps	48
Pean Trocars	212
Pederson Vaginal Specula	405,406
Peers Towel Forceps	62
Peet Splinter Forceps	44
Pelvimeters	440
Penfield Dura Dissectors	116
Pennington Hemostatic Forceps	53
Pennington Septum and Periosteal Elevators	463
Percussion Hammers	3,4
Percy Amputating and Resection Saws	280
Periosteal Elevators	463

Periosteal Raspatories	306-312
Perthes Bone Drills	281
Pierce Septum and Periosteal Elevators	463
Pierce Trocars	212
Pin Cutters With TC Inserts	179,180
Pinard Stethoscopes	7
Piper Obstetrical Forceps	441
Placenta Forceps	442
Plaster Cast Instruments	162,163
Plaster Spatula	225
Plaster-of-Paris knives	161
Plaster-of-Paris Shears	161
Plester Retractors	260
Plester Suction Tubes	216
Pley Capsular Forceps	497
Politzer Paracentesis Needles	489
Polypus Forceps	66,67
Poole Suction Tubes	218
Post Mortem Knives	85
Pottos-Smith Dressing Forceps	27
Pottos-Smith Tissue Forceps	33
Potts-Smith Forceps With TC Jaws	166
Potts-Smith Vascular Scissors	149,150
Precisa Blood Pressure Manometers	10
Presbyterian Tubing clamps	64
Price-Thomas Brochus Clamps	361
Prince Tonsil Scissors	152
Prince Trachoma Forceps	500
Probes	223,224
Proctoscopes	90-92
Prostatic Retractors	399
Providence Hospital Hemostatic Forceps	52
Putti Rasps	315
Pylorus Spreader	381
Q	
Quervain Elevators	312
Quire Foreign Body Levers	493
R	
Rabiner Percussion Hammers	4
Ragnell-Davis Retractors	255
Ralk Hand Bone Drills	285
Ralk Splinter Forceps	44
Rampley Sponge Holding Forceps	69
Randall Biopsy Curettes	433
Randall Kidney Stone Forceps	388
Raney Forceps for Scalp Clips	107
Raney Scalp Clips	107
Rasps	315
Reamers	281
Recamier Uterine Curettes	436
Rectal Biopsy Specimen Forceps	97,98
Rectal Snares	100
Rectal Specula	93,95,96
Reill Micro Scissors	518
Reiner Plaster-of-Paris Knives	161
Reposition Bone Holding Forceps	328,329
Resection Knives	84
Resection Saws	279,280
Retractors	228-264,484
Reverdin Abdominal and Intestinal Spatulas	276
Reverdin Needles	207,208
Reynolds Dissecting Scissors	150
Rhinoplastic Knives	472
Rib Contractors	359
Rib Shears	347-349
Rib Spreaders	354-358
Rib Spreaders from Aluminium	350-353
Ricard Abdominal Retractors	265
Richardson Retractors	239
Richardson-Eastman Retractors	240
Richter Operating Scissors	141
Rigby Abdominal Retractors	273
Rirap Stethoscopes	8
Roberts Hemostatic Forceps	55
Rochester-Carmalt Hemostatic Forceps	50
Rochester-Pean Hemostatic Forceps	48
Roeder Towel Forceps	62
Rogge Sterilizing Forceps	69
Rose Trachea Retractors	365
Rosen Curette	488
Rosen Elevators	488
Rosen Hooklets	488
Rosen Periosteal Raspatory	488
Roser Directors	224
Roser-Konig Mouth Gags	475
Rotokurette Biopsy Curettes	433
Rottgen-Ruskin Bone Rongeur Forceps	334
Roux Retractors	257

Rubin Nasal Osteotomes	
Rubin Septum Forceps	
Rubin TC Septum Forceps	
Rudd Haemorrhoidal Ligators	89
Rumel Hemostatic Forceps	55
Ruskin Bone Cutting Forceps	344
Ruskin Bone Rongeur Forceps	334
Ruskin-Liston Bone Cutting Forceps	344
Russel-Davis Mouth Gags	479
Rust Amputating and Resection Saws	280
Rydel-Seiffer Tuning Forks	18
S	
Saalfeld Comedo Extractors	74
Sachs Dura Dissectors	118
Sachs Dura Hooks	122
Saenger Ovum Forceps	442
Salenius Meniscomotomy Knives	316
Sarot Hemostatic Forceps	55
Sarot Needle Holder With TC Jaws	173
Sarot Needle Holders	183
Satinsky Blood Vessel Clamps	361
Satinsky Vascular Scissors	150
Satterlee Amputating and Resection Saws	279
Sauerbruch Bone Rongeur Forceps	341
Sauerbruch Retractors	238,250
Sauerbruch Rib Shears	349
Sauerbruch-Frey Rib Shears	349
Scalpel Contour Retractors	259
Scalpel Blades	81,82
Scalpel Handles	79,80
Schadel Towel Forceps	62
Schamberg Comedo Extractors	74
Schede Bone Curettes	300
Scherbak Vaginal Specula	411
Schink Dermatomes	72
Schioetz Tonometer	12
Schlesinger Intervertebral Disc Rongeurs	123
Schmieden Dura Scissors	151
Schmieden Ligature Conductors	205
Schmieden Ligature Needles	202
Schmieden-Dick Ligature Needles	202
Schmieden-Payr Ligature Conductors	205
Schmidt Tonsil Seizing Forceps	482
Schoenborn Thyroid Gland Retractor	365
Schroder Tenaculum Forceps	420
Schroder Uterine Curettes	439
Schroder-Braun Tenaculum Forceps	419
Schubert Biopsy Punches	430
Schuhmacher Biopsy Punches	427,428,430
Schultze Hystero-Salpingography	13
Schumacher Biopsy Punches	429
Schumacher Umbilical Scissors	148
Schweiger Capsular Forceps	497
Scissors with TC edges	176-178
Scoville Laminectomy Spreaders	131
Scoville Laminectomy Spreaders Blades	132
Scoville Laminectomy Spreaders Hooks	132
Scoville Nerve Root Retractors	120
Scoville-Haverfield Laminectomy Spreaders	131
Screw Drivers	282
Screw Nut Wrench	283
Secondary Cataract Scissors	513
Sedillot Periosteal Raspatories	306
Sehr Fein Micro Ear Polypus Forceps	492
Seiler Nasal Scissors	152
Semb Bone Cutting Forceps	344
Semb Bone Holding Forceps	327
Semb Bone Rongeur Forceps	339
Semb Periosteal Raspatories	309
Semken Dressing Forceps	26
Semken Tissue Forceps	30
Semm Vaginal Specula	407
Senn-Green Retractors	255
Senn-Miller Retractors	255
Septum Elevators	462,463
Septum Forceps	452,460
Septum Gouges	466
Sequestum Bone Holding Forceps	326
Serpentine Grasper Flexible IUD	424
Set of 5 Aluminium Tuning Forks	21
Set of 6 Aluminium Tuning Forks	22
Set of 8 Aluminium Tuning Forks	22
Setter Bone Holding Forceps	327
Seutin Plaster-of-Paris Shears	161
Sexton Tympanum Knives	489
Seyffert Vaginal Specula	405
Shapleigh Ear Curettes	487
Siebold Utrine Scissors	146

Silver Dematomes	72	Taylor Spinal Retractors	
Silver Nasal Osteotomes	466	Teale Tenaculum Forceps	
Simon Bone Curettes	303	Temple-Fay Abdominal Retr	
Simon Retractors	248	Tenaculum Forceps	419-421
Simon Uterine Curettes	439	Tendon Instruments	313
Simpson-Braun Obstetrical Forceps	440	Thomas Towel Forceps	64
Simpson-Luikart Obstetrical Forceps	440	Thomas Uterine Curettes	435
Sims (Bodenhammer) Rectal Specula	95	Thoms-Allis Tissue Grasping Forceps	379
Sims Operating Scissors	146	Thoms-Gaylor Biopsy Punches	432
Sims Rectal Specula	95,96	Thudichum (Goldsmith) Nasal Specula	455
Sims Uterine Curettes	435	Thyroid Gland Retractor	365
Sims Uterine Sounds	418	Tieck-Halle Nasal Specula	453
Sims Vaginal Specula	407	Tischler Biopsy Punches	425,431
Singley-Tuttle Lung Grasping Forceps	34	Tischler-Kevorkian Biopsy Punches	425
Sistrunck Nail Splitting Scissors	153	Tissue Forceps	29-33
Skene Tenaculum Forceps	419	Tissue Forceps Delicate	37
Sluder-Ballenger Tonsillectomes	485	Tissue Grasping Forceps	379,380
Smedberg Hand Bone Drills	285	Tissue Seizing Forceps with TC Jaws	175
Smillie Menisectomy Knives	316	Tobold Tongue Depressors	480
Smith Bandage Scissors	159	Toe and Finger Nail Forceps	138
Smith-Buie Anal Retractors	93	Toennis Dura Dissectors	117
Smith-Green Cataract Knives	504	Toennis Dura Hooks	122
Smith-Petersen Bone Chisels	296	Tongue Depressors	480
Smith-Petersen Bone Rongeur Forceps	340	Tongue Holding Forceps	481
Smith-Petersen Osteotomes	295	Tonnis Dissecting Scissors	150
Smithwick Nerve Hooks	121	Tonnis-Adson Scissors with TC edges	178
Snellen Entropium Forceps	501	Tonometer	12
Somer Uterine Elevating Forceps	423	Tonsil Knives	484
Spencer Ligature Scissors	153	Tonsil Scissors	152
Spencer-Wells Hemostatic Forceps	52	Tonsil Seizing Forceps	482
Sphenoid Punches	461	Tonsil Snares	483
Sphincteroscopes	92	Tonsillectomes	485
Spinal Bone Curettes	305	Towel Forceps	62-64
Splinter Forceps	38,39,44	Trachea Dilators	364
Sponge Holding Forceps	68,69	Trachea Retractors	364,365
Spratt Bone Curettes	300,305	Trachea Trocars	366
Spurling Intervertebral Disc Rongeurs	126	Trachea Tubes	366
St. Clair-Thomson Adenoid Curettes	473	Transformer	377
St. Martin Suture Forceps	499	Traube Percussion Hammers	3
Stacke Probes	223	Trocars	210-213
Standard Pocket Cases	196	Troeltsch (Wilde) Nasal, Ear Dressing Forceps	458
Staude-Moore Tenaculum Forceps	420	Troemner Percussion Hammers	3
Steel Wire For Nasal Snares	456,483	Trousseau Trachea Dilators	364
Steel Wire For Rectal Snares	100	Troutman Micro Corneal Scissors	513
Stellbrink Bone Rongeur Forceps	337	Tubing Clamps	64,65
Sterilizing Forceps	69	Tubinger Modell Retractors	261
Stethoscopes	7,8	Tuffier Abdominal and Intestinal Spatulas	276
Stevens Iris Forceps	496	Tuffier Rib Spreaders	355
Stevens Supercut Scissors	157	Tumor Forceps	40
Stevens Tenotomy Scissors	520	Tuning Forks	16,22
Stevenson Eye Specula	511	Tyding Tonsil Snares	483
Stieglitz Splinter Forceps	44	Tympanum Knives	489
Stille Bone Chisels	294	U	
Stille Bone Rongeur Forceps	335	Uckermann Cotton Applicators	225
Stille Gouges	294,295	Uckermann Trachea Trocars	366
Stille Hand Bone Drills	287	Ulrich Bone Holding Forceps	333
Stille Osteotomes	294,295	Ulrich Cotton Swab Forceps	66
Stille Plaster-of-Paris Shears	161	Uni-Burke Biopsy Punches	427,428
Stille-Liston Bone Cutting Forceps	342	Uni-Kevorkian Biopsy Punches	427,428
Stille-Luer Bone Rongeur Forceps	335	Uni-Oval Biopsy Punches	427,428
Stille-Ruskin Bone Rongeur Forceps	339	Uni-Tischler Biopsy Punches	427,428
Stockmann Penis Seizing Forceps	398	Uni-Townsend Biopsy Punches	427,428
Strabismus Forceps	499,500	Universal Interchangeable Handles For ..	99
Strabismus Forceps	499,500	Rectal Biopsy Specimen Forceps	
Strabismus Hooks	508	Universal Trocars	210
Strandell-Stille Retractors	232	Universal Wire Cutting Scissors	153
Stratte Needle Holder With TC Jaws	171	Universal Wire Cutting Scissors with TC edges	179
Stratte Needle Holders	185	Unna Comedo Extractors	74
Strauss Penis Seizing Forceps	398	Unna-Vidal Comedo Extractors	74
Struempel Ear Polypus Forceps	490	USA Mod. Umbilical Scissors	148
Strully Vascular Scissors	151	USA Modell Plaster Cast Instrument	163
Struycken Nasal Cutting Forceps	449	USA-Mod Dressing Forceps	26
Suction Tubes	100,215-218	USA-Mod Tissue Forceps	29
Super Fein Micro Ear Polypus Forceps	492	Uterine Curettes	435-439
Supercut Scissors	155-157	Uterine Depressors	418
Surgical Needles	188	Uterine Dilators	415-418
Suture Forceps	497-500	Uterine Elevating Forceps	422,423
Suture Tying Forceps	501	Uterine Hemostasis Forceps	443
Swivel Knives	471	Uterine Polypus Forceps	422
Syringes	220,221	Uterine Sounds	418
T		V	
Takahashi Nasal Cutting Forceps	446	Vaginal Specula	402-409,411
Tape Measuring Instruments	6	Van Buren Bone Holding Forceps	328
Taps with Cross Handle	282	Van Doren Biopsy Punches	432
Taylor Tissue Forceps	32,33	Vannas Micro Scissors	518
Taylor Dressing Forceps	27	Vannas Secondary Cataract Scissors	513
Taylor Laminectomy Spreaders Blades	132	Varicose Vein Probe Set	226
Taylor Percussion Hammers	3	Vascular Dilators	362

Vascular Scissors	149-151
Vein and Eye Needles	193
Verbrugge Bone Holding Forceps	332,333
Verbrugge-Baby Bone Holding Forceps	332
Verres Cannulas	217
Vidal Lupus Scraper	73
Virchow Autopsy Knives	86
Virchow Brain Knife	85
Vogel Adenoid Curettes	473
Volkman Bone Curettes	300,301,304
Volkman Retractors	232-234

W	
Wachenfeldt Clip Applying Forceps	195
Wagener Ear Hooks	488
Wagner Laminectomy Rongeurs	125
Wagner Periosteal Raspatories	307
Walb Post Mortem Knife	85
Waldmann Perineum Scissors	147
Walter Chisels	465
Walter-Carmalt Splinter Forceps	39
Walton Interchangeable Handles For ..	99
Rectal Biopsy Specimen Forceps	
Wangensteen Forceps With TC Jaws	167
Wangensteen Needle Holder With TC Jaws	170
Wangensteen Needle Holders	185
Wartenberg Examination Instruments	5
Wassmund Retractors	235
Watson-Cheyne Directors	224
Waugh Dressing Forceps	28
Waugh Tissue Forceps	32
Weber Canaliculus Knives	504
Webster Needle Holder With TC Jaws	171
Webster Needle Holders	182
Wecker Iridectomy Scissors	517
Weil-Blakesley Nasal Cutting Forceps	445
Weiss Amputating and Resection Saws	280
Weitlaner-Baby Retractors	259
Weitlaner-Loktite Retractors	259
Weitlaner-Wullstein Retractors	259
Wertheim Clamp Forceps	60,61
Wertheim Dissecting Scissors	145
Wertheim-Cullen Clamp Forceps	60
Wessely-Griehaber Keratomes	505
Westcott Tenotomy Scissors	514
Westmacott Nasal Forceps	459
White Tonsil Seizing Forceps	482
Whitehead Mouth Gags	475
Wieder Tongue Depressors	480
Wiener Eye Hooks	507
Wiener Nasal Rasps	468
Wilde Nasal Cutting Forceps	449
Wilder Lachrymal Dilators	508
Williams Eye Specula	510
Williams Intestinal Forceps	380
Williger Bone Curettes	301,302
Williger Elevators	312
Williger Mallets	322
Williger Periosteal Raspatories	307
Winter Placenta Forceps	442
Wire Cutters With TC Inserts	179,180
Wire Cutting Pliers	289,290
Wire Cutting Scissors	153
Wire Strainer	283
Wittner Biopsy Punches	429
Wolff Lupus Curettes	73
Wolff Plaster Cast Instrument	162
Woodruff Ligature Needles	203
Wullstein Suction Tubes	215
Wundsparklammern Suture Clips	196

Y	
Yankauer Suction Tubes	218
Yasargil Galea Hooks	115
Yasargil Ligature Guides	111
Yasargil Micro Raspatories	112
Yasargil Micro Raspatories	113
Yasargil Micro Scoopes	113
Yasargil Micro Vessel Knives	114
Yasargil Pituitary Rongeurs	125
Yasargil Suture Pusher	113
Yasargil Tumor Forceps	40
Yoeman (Turrell) Rectal Biopsy Forceps	98
Yoeman Interchangeable Handles For ..	99
Rectal Biopsy Specimen Forceps	
Yoeman Rectal Biopsy Specimen Forceps	97
Young Prostatic Retractors	399
Young Tongue Holding Forceps	481

Z	
Zaufal Bone Rongeur Forcep	
Zaufal-Jansen Bone Rongeu	
Zenker Ligature Forceps	57
Zenker Retractors	245
Ziegler Iris Knives	504
Zweifel Uterine Curettes	438

Cat. Nr. Cat.-No Kat.-Nr. No. ref.	Biz. Page Seite Pagina	Cat. Nr. Cat.-No Kat.-Nr. No. ref.	Biz. Page Seite Pagina	Cat. Nr. Cat.-No Kat.-Nr. No. ref.	Biz. Page Seite Pagina	Cat.-No Kat.-Nr. No. ref.	Page Seite Pagina
11.8	2	11.135	13	12.225	25	12.332	29
11.9	2	11.136	14	12.226	25	12.333	29
11.10	2	11.150	15	12.227	25	12.334	29
11.11	2	11.151	15	12.230	25	12.340	29
11.12	2	11.152	15	12.231	25	12.341	29
11.13	2	11.153	15	12.232	25	12.342	29
11.14	2	11.154	15	12.233	25	12.343	29
11.15	2	11.155	15	12.234	25	12.344	29
11.16	2	11.156	15	12.235	25	12.345	29
11.17	2	11.157	15	12.236	25	12.346	29
11.18	2	11.160	15	12.237	25	12.347	29
11.19	2	11.161	15	12.241	25	12.350	29
11.20	2	11.162	15	12.242	25	12.351	29
11.25	2	11.163	15	12.247	25	12.352	29
11.28	2	11.164	15	12.248	25	12.353	29
11.29	2	11.180-00	16	12.249	25	12.354	29
11.30	2	11.180-01	16	12.250	26	12.355	29
11.31	2	11.180-02	16	12.251	26	12.356	29
11.32	2	11.180-03	16	12.252	26	12.357	29
11.33	2	11.180-04	16	12.253	26	12.371	30
11.34	2	11.180-05	16	12.254	26	12.372	30
11.35	2	11.180-06	16	12.255	26	12.373	30
11.36	2	11.180-07	16	12.256	26	12.374-15	30
11.37	2	11.180-08	16	12.257	26	12.374-20	30
11.38	2	11.180-09	16	12.260	26	12.374-25	30
11.39	2	11.181-00	17	12.261	26	12.375-15	30
11.40	2	11.181-01	17	12.262	26	12.375-20	30
11.45	3	11.181-02	17	12.263	26	12.375-25	30
11.46	3	11.181-03	17	12.265	26	12.381	30
11.47	3	11.181-04	17	12.266	26	12.382	30
11.48	3	11.181-05	17	12.267	26	12.384	30
11.49	3	11.181-06	17	12.271	26	12.384-15	30
11.50	4	11.182-01	18	12.272	26	12.385	30
11.51	4	11.182-02	18	12.274	26	12.385-15	30
11.52	4	11.183-01	18	12.275	26	12.386	31
11.53	4	11.184-01	19	12.277	26	12.387	31
11.56	5	11.185-01	19	12.280	27	12.388	31
11.57	5	11.186-01	19	12.281	27	12.389	31
11.58	5	11.186-02	19	12.282	27	12.390	32
11.59	5	11.187-00	20	12.283	27	12.391	32
11.60	5	11.187-01	20	12.284	27	12.392	32
11.61	6	11.187-02	20	12.285	27	12.393	32
11.62	6	11.187-03	20	12.288	27	12.394	32
11.64	6	11.187-04	20	12.289	27	12.395	32
11.65	6	11.188-00	21	12.290	27	12.396	32
11.66	6	11.189-05	21	12.291	27	12.397	32
11.67	6	11.189-06	22	12.292	27	12.398	33
11.68	6	11.189-08	22	12.293	27	12.399	33
11.69	6	12.101	24	12.294	28	12.400	33
11.70	6	12.102	24	12.295	28	12.401	33
11.71	7	12.103	24	12.296	28	12.402	33
11.72	7	12.104	24	12.297	28	12.403	33
11.73	7	12.105	24	12.298	28	12.404	33
11.75	7	12.106	24	12.299	28	12.405	33
11.76	7	12.107	24	12.300	29	12.407	33
11.77	8	12.199	25	12.301	29	12.408	33
11.78	8	12.200	25	12.302	29	12.409	33
11.79	8	12.201	25	12.303	29	12.410	33
11.80	9	12.202	25	12.304	29	12.411	33
11.81	9	12.203	25	12.305	29	12.412	33
11.82	9	12.204	25	12.306	29	12.413	34
11.83	9	12.205	25	12.307	29	12.414	34
11.84	10	12.206	25	12.308	29	12.415	34
11.85	10	12.207	25	12.310	29	12.416	34
11.86	11	12.209	25	12.311	29	12.417	34
11.118	11	12.210	25	12.312	29	12.419	34
11.119	11	12.211	25	12.313	29	12.420-16	35
11.120	11	12.212	25	12.314	29	12.420-20	35
11.121	11	12.213	25	12.315	29	12.420-24	35
11.122	11	12.214	25	12.316	29	12.420-30	35
11.123	11	12.215	25	12.317	29	12.421-16	35
11.124	11	12.216	25	12.321	29	12.421-20	35
11.125	11	12.217	25	12.322	29	12.421-24	35
11.126	11	12.220	25	12.323	29	12.421-30	35
11.127	11	12.221	25	12.327	29	12.422-16	35
11.130	12	12.222	25	12.328	29	12.422-20	35
11.131	12	12.223	25	12.329	29	12.422-24	35
11.132	12	12.224	25	12.331	29	12.422-30	35

Cat. Nr. Cat.-No Kat.-Nr. No. ref.	Biz. Page Seite Pagina	Cat. Nr. Cat.-No Kat.-Nr. No. ref.	Biz. Page Seite Pagina	Cat. Nr. Cat.-No Kat.-Nr. No. ref.	Biz. Page Seite Pagina	Cat.-No Kat.-Nr. No. ref.	Page Seite Pagina
12.423-16	35	13.478	44	14.585	49	14.669-20	56
12.423-20	35	13.479	44	14.586	49	14.670-20	56
12.423-24	35	13.480	44	14.587	49	14.667-26	56
12.423-30	35	13.481	44	14.589	49	14.668-26	56
12.424-16	35	13.482	44	14.591	50	14.669-26	56
12.424-20	35	13.483	44	14.593	50	14.670-26	56
12.424-24	35	13.484	44	14.595	50	14.671-18	57
12.424-30	35	14.497	46	14.596	50	14.671-22	57
12.425	36	14.498	46	14.597	50	14.671-25	57
12.426	36	14.499	46	14.598	50	14.671-28	57
12.427	36	14.500	46	14.599	50	14.672-13	57
12.428	37	14.501	46	14.600	50	14.672-14	57
12.429	37	14.502	46	14.601	51	14.672-16	57
12.430	37	14.503	46	14.602	51	14.672-18	57
12.431	38	14.504	46	14.603	51	14.672-20	57
12.432	38	14.505	46	14.604	51	14.672-23	57
12.433	38	14.506	46	14.605	51	14.672-25	57
12.434	38	14.507	46	14.606	51	14.672-28	57
12.435	38	14.508	46	14.607	51	14.673-01	57
12.436	38	14.509	46	14.608	51	14.673-02	57
12.437	38	14.510	47	14.609	51	14.675	58
12.438	38	14.511	47	14.610	51	14.675-18	58
12.439	38	14.512	47	14.611	52	14.676	58
12.440	38	14.513	47	14.612	52	14.677	58
12.441	38	14.514	47	14.614	52	14.678	58
12.442	38	14.515	47	14.615	52	14.679	58
12.443	38	14.516	47	14.617	52	14.680	58
12.444	38	14.517	47	14.618	52	14.681	58
12.445	38	14.518	47	14.619	52	14.682	58
12.446	38	14.519	47	14.620	52	14.684-18	59
12.447	38	14.520	47	14.621	52	14.684-24	59
12.448	38	14.521	47	14.622	52	14.684-28	59
12.449	38	14.522	47	14.623	52	14.685	59
12.450	38	14.523	47	14.624	52	14.686	59
12.451	38	14.525	47	14.625	52	14.687	59
12.452	38	14.526	47	14.626	52	14.692	59
12.453	38	14.527	47	14.627	52	14.693	59
12.454	38	14.528	47	14.628	52	14.712	60
12.455	38	14.529	47	14.629	52	14.713	60
12.456	38	14.530	47	14.630	52	14.716	60
12.457	38	14.531	48	14.631	52	14.717	60
12.458	38	14.532	48	14.632	52	14.722	60
12.459	38	14.533	48	14.634	53	14.723	60
12.460	38	14.535	48	14.635	53	14.730	60
12.461	38	14.538	48	14.636	53	14.732	60
12.462	38	14.540	48	14.637	53	14.733	60
12.463	38	14.541	48	14.640	53	14.734	61
12.464	38	14.542	48	14.641	53	14.735	61
12.465	38	14.543	48	14.642	53	14.737	61
12.466	38	14.544	48	14.643	53	14.738	61
12.467	38	14.545	48	14.644	54	14.739	61
12.468	38	14.546	48	14.645	54	14.740	61
12.469	38	14.547	48	14.646	54	14.761	62
12.470	38	14.549	48	14.650-01	54	14.762	62
12.471	39	14.551	48	14.650-02	54	14.763	62
12.472	39	14.552	48	14.650-03	54	14.764	62
12.473	39	14.553	48	14.650-04	54	14.770	62
12.474	39	14.554	48	14.650-05	54	14.771	62
12.475	39	14.555	48	14.650-06	54	14.772	62
12.476	39	14.556	48	14.650-07	54	14.773	62
12.477	39	14.557	48	14.651-01	54	14.774	62
12.485	39	14.559	48	14.651-02	54	14.775	62
12.486	39	14.561	49	14.651-03	54	14.776	62
12.487-03	40	14.563	49	14.651-04	54	14.777	62
12.487-05	40	14.566	49	14.651-05	54	14.778	63
12.488-03	40	14.568	49	14.651-06	54	14.780	63
12.488-05	40	14.571	49	14.651-07	54	14.781	63
12.489-03	40	14.572	49	14.655	55	14.782	63
12.489-05	40	14.573	49	14.656	55	14.783	63
12.491	41	14.574	49	14.657	55	14.785	63
12.492	41	14.575	49	14.658	55	14.786	63
12.493	41	14.576	49	14.660	55	14.787	63
12.494-01	41	14.577	49	14.661	55	14.788	63
12.494-02	41	14.579	49	14.662	55	14.788-10	64
12.495-01	42	14.581	49	14.665	55	14.788-13	64
12.495-02	42	14.582	49	14.666	55	14.789	64
12.495-03	42	14.583	49	14.667-20	56	14.790	64
12.496	42	14.584	49	14.668-20	56	14.791	65

Cat. Nr. Cat.-No Kat.-Nr. No. ref.	Biz. Page Seite Pagina	Cat. Nr. Cat.-No Kat.-Nr. No. ref.	Biz. Page Seite Pagina	Cat. Nr. Cat.-No Kat.-Nr. No. ref.	Biz. Page Seite Pagina	Cat.-No Kat.-Nr. No. ref.	Page Seite Pagina
14.792	65	15.966	74	16.1136	82	17.1225-04	96
14.793	65	15.967	74	16.1171	83	17.1230-28	97
14.796	65	15.968-11	74	16.1172	83	17.1230-35	97
14.797	65	15.968-14	74	16.1173	83	17.1230-42	97
14.798	65	15.969	74	16.1174	83	17.1231-28	97
14.821	66	15.970	74	16.1175	83	17.1231-35	97
14.822	66	16.1001	76	16.1176	83	17.1231-42	97
14.825	66	16.1002	76	16.1177	83	17.1233-33	98
14.826	66	16.1003	76	16.1178	83	17.1233-40	98
14.827	66	16.1004	76	16.1179	83	17.1233-01	98
14.851	66	16.1005	76	16.1185	83	17.1233-02	98
14.852	66	16.1006	76	16.1186	83	17.1234-33	98
14.853	66	16.1007	76	16.1187	83	17.1234-40	98
14.854	66	16.1008	76	16.1188	83	17.1234-01	98
14.855	67	16.1009	76	16.1189	84	17.1234-02	98
14.856	67	16.1010	76	16.1190	84	17.1235-33	98
14.857	67	16.1011	76	16.1191	84	17.1235-40	98
14.858	67	16.1012	76	16.1194-11	85	17.1235-01	98
14.861	67	16.1013	76	16.1194-14	85	17.1235-02	98
14.862	67	16.1014	76	16.1194-17	85	17.1236-33	98
14.865	67	16.1015	76	16.1195-16	85	17.1236-40	98
14.866	67	16.1016	76	16.1195-20	85	17.1236-01	98
14.867	67	16.1017	76	16.1195-24	85	17.1236-02	98
14.868	67	16.1018	76	16.1196	86	17.1240-01	99
14.869	67	16.1026	77	16.1197	86	17.1240-02	99
14.871	68	16.1027	77	16.1198	86	17.1240-03	99
14.873	68	16.1032	77	16.1199	86	17.1245-01	100
14.881	68	16.1036	77	17.1201-08	88	17.1245-02	100
14.882	68	16.1037	77	17.1201-10	88	17.1246-15	100
14.883	68	16.1038	77	17.1202-08	88	17.1250-31	100
14.884	68	16.1040	77	17.1202-10	88	17.1250-03	100
14.885	68	16.1046	77	17.1202-01	88	17.1251-36	101
14.886	68	16.1060	77	17.1202-02	88	17.1252-28	101
14.887	68	16.1061	77	17.1203-05	88	17.1252-38	101
14.888	68	16.1062	77	17.1203-01	89	17.1253-28	101
14.889	68	16.1063	77	17.1203-12	89	17.1253-38	101
14.890	68	16.1071	78	17.1204-01	89	17.1261-35	102
14.891	68	16.1072	78	17.1204-02	89	17.1261-45	102
14.892	68	16.1073	78	17.1205-20	89	17.1261-60	102
14.893	68	16.1074	78	17.1207-01	90	17.1262-35	102
14.894	68	16.1075	78	17.1207-02	90	17.1262-45	102
14.897	69	16.1076	78	17.1207-03	90	17.1262-60	102
14.898	69	16.1081	78	17.1207-04	90	17.1265-01	102
14.901	69	16.1082	78	17.1207-05	90	17.1265-02	102
14.902	69	16.1083	78	17.1207-06	90	17.1265-03	102
14.903	69	16.1084	78	17.1207-10	90	17.1265-04	102
14.906	69	16.1085	78	17.1208-01	90	17.1265-05	102
14.907	69	16.1086	78	17.1208-02	90	17.1265-06	102
14.908	69	16.1087	78	17.1208-03	90	17.1265-07	102
14.909	69	16.1088	78	17.1208-04	90	17.1265-08	102
14.910	69	16.1089	78	17.1209-22	91	17.1266-01	102
15.922	71	16.1091	79	17.1209-30	91	17.1266-02	102
15.923	71	16.1092	79	17.1210-22	91	17.1266-03	102
15.924	71	16.1092G	79	17.1210-30	91	17.1266-04	102
15.925	71	16.1095	79	17.1211-21	92	17.1266-05	102
15.926	71	16.1096	79	17.1211-25	92	18-1320-30	104
15.927	71	16.1096G	79	17.1212-01	92	18-1320-40	104
15.928	71	16.1097	80	17.1212-02	92	18-1320-50	104
15.929	71	16.1097K	80	17.1212-03	92	18-1320-60	104
15.930	71	16.1098	80	17.1212-04	92	18-1320-70	104
15.950	72	16.1099	80	17.1213-22	92	18.1321-30	104
15.951	72	16.1110	81	17.1214-22	92	18.1321-40	104
15.952	72	16.1111	81	17.1215-01	93	18.1321-50	104
15.953	72	16.1112	81	17.1215-02	93	18.1322-50	104
15.960-01	73	16.1113	81	17.1215-10	93	18.1323-00	104
15.960-02	73	16.1114	81	17.1216-17	93	18.1324-30	104
15.961-15	73	16.1115	81	17.1218-15	93	18.1324-33	104
15.962-14	73	16.1116	81	17.1220-00	94	18.1328-20	104
15-964-01	73	16.1117	81	17.1220-01	94	18.1329-21	104
15-964-02	73	16.1118	82	17.1220-02	94	18.1340-00	105
15-964-03	73	16.1119	82	17.1220-03	94	18.1340-01	105
15-964-04	73	16.1120	82	17.1220-04	94	18.1341-01	105
15-965-01	73	16.1121	82	17.1223-22	95	18.1341-02	105
15-965-02	73	16.1122	82	17.1224-01	95	18.1341-04	105
15-965-03	73	16.1123	82	17.1224-02	95	18.1341-05	105
15-965-04	73	16.1124	82	17.1225-01	96	18.1345-16	106
15-965-05	73	16.1125	82	17.1225-02	96	18.1345-17	106
15-965-06	73	16.1134	82	17.1225-03	96	18.1345-27	106

Cat. Nr. Cat.-No Kat.-Nr. No. ref.	Biz. Page Seite Pagina	Cat. Nr. Cat.-No Kat.-Nr. No. ref.	Biz. Page Seite Pagina	Cat. Nr. Cat.-No Kat.-Nr. No. ref.	Biz. Page Seite Pagina	Cat.-No Kat.-Nr. No. ref.	Page Seite Pagina
18-1350-01	107	18-1415-02	119	18-1480-03	127	18-1512-18	130
18-1350-02	107	18-1415-03	119	18-1480-04	127	18-1513-18	130
18-1351-00	107	18-1416-01	120	18-1480-05	127	18-1514-18	130
18-1352-00	107	18-1416-02	120	18-1480-06	127	18-1515-18	130
18-1353-00	107	18-1417-24	120	18-1481-01	127	18-1516-18	130
18-1354-00	107	18-1420-19	121	18-1481-02	127	18-1512-20	130
18-1360-15	108	18-1421-19	121	18-1481-03	127	18-1513-20	130
18-1360-19	108	18-1420-28	121	18-1481-04	127	18-1514-20	130
18-1361-15	108	18-1421-28	121	18-1481-05	127	18-1515-20	130
18-1361-19	108	18-1423-17	121	18-1481-06	127	18-1516-20	130
18-1362-14	108	18-1423-21	121	18-1482-01	127	18-1522-15	130
18-1364-01	109	18-1422-20	121	18-1482-02	127	18-1523-15	130
18-1364-02	109	18-1424-20	121	18-1482-03	127	18-1524-15	130
18-1364-03	109	18-1425-01	122	18-1482-04	127	18-1525-15	130
18-1364-04	109	18-1425-02	122	18-1482-05	127	18-1526-15	130
18-1365-08	109	18-1426-13	122	18-1482-06	127	18-1522-18	130
18-1365-11	109	18-1426-18	122	18-1483-01	127	18-1523-18	130
18-1365-14	109	18-1428-14	122	18-1483-02	127	18-1524-18	130
18-1365-17	109	18-1430-15	122	18-1483-03	127	18-1525-18	130
18-1365-20	109	18-1431-18	122	18-1483-04	127	18-1526-18	130
18-1366-01	109	18-1432-16	122	18-1483-05	127	18-1522-20	130
18-1366-02	109	18-1438-20	122	18-1483-06	127	18-1523-20	130
18-1366-03	109	18-1440-01	123	18-1486-01	127	18-1524-20	130
18-1366-04	109	18-1440-02	123	18-1486-02	127	18-1525-20	130
18-1367-01	109	18-1440-03	123	18-1486-03	127	18-1526-20	130
18-1367-02	109	18-1441-02	123	18-1486-04	127	18-1540-00	131
18-1367-03	109	18-1441-03	123	18-1486-05	127	18-1540-01	131
18-1367-04	109	18-1441-04	123	18-1486-06	127	18-1541-00	131
18-1369-01	110	18-1442-02	124	18-1487-01	127	18-1541-01	131
18-1369-02	110	18-1442-03	124	18-1487-02	127	18-1543-50	132
18-1369-03	110	18-1442-04	124	18-1487-03	127	18-1543-70	132
18-1369-04	110	18-1443-02	124	18-1487-04	127	18-1543-75	132
18-1370-02	111	18-1443-03	124	18-1487-05	127	18-1544-50	132
18-1370-03	111	18-1443-04	124	18-1487-06	127	18-1544-70	132
18-1370-04	111	18-1444-02	124	18-1488-01	127	18-1544-75	132
18-1371-02	111	18-1444-03	124	18-1488-02	127	18-1545-01	132
18-1371-03	111	18-1444-04	124	18-1488-03	127	18-1545-02	132
18-1371-04	111	18-1445-02	124	18-1488-04	127	18-1545-03	132
18-1372-19	112	18-1445-03	124	18-1488-05	127	18-1545-04	132
18-1373-19	112	18-1445-04	124	18-1488-06	127	18-1546-01	132
18-1374-00	112	18-1446-02	124	18-1489-01	127	18-1547-01	132
18-1374-04	112	18-1446-03	124	18-1489-02	127	18-1547-02	132
18-1374-05	112	18-1446-04	124	18-1489-03	127	18-1547-03	132
18-1374-06	112	18-1447-02	124	18-1489-04	127	18-1547-04	132
18-1375-01	113	18-1447-03	124	18-1489-05	127	18-1548-01	132
18-1375-02	113	18-1447-04	124	18-1489-06	127	18-1548-02	132
18-1375-03	113	18-1447-20	125	18-1484-01	128	18-1549-01	132
18-1375-04	113	18-1448-18	125	18-1484-02	128	18-1549-02	132
18-1376-19	113	18-1449-18	125	18-1484-03	128	18-1550-01	132
18-1377-19	113	18-1450-12	126	18-1484-04	128	18-1550-02	132
18-1378-19	113	18-1450-15	126	18-1484-05	128	18-1550-03	132
18-1379-19	114	18-1450-18	126	18-1484-06	128	18-1560-01	133
18-1380-01	114	18-1451-12	126	18-1485-01	128	18-1560-00	133
18-1380-02	114	18-1451-15	126	18-1485-02	128	18-1561-40	133
18-1380-03	114	18-1451-18	126	18-1485-03	128	18-1561-45	133
18-1381-19	114	18-1452-12	126	18-1485-04	128	18-1561-50	133
18-1382-19	114	18-1452-15	126	18-1485-05	128	18-1561-55	133
18-1395-01	115	18-1452-18	126	18-1485-06	128	18-1561-60	133
18-1395-02	115	18-1460-12	126	18-1502-15	129	18-1562-01	133
18-1401-01	116	18-1460-15	126	18-1503-15	129	18-1562-00	133
18-1401-02	116	18-1460-18	126	18-1504-15	129	18-1562-40	133
18-1401-03	116	18-1461-12	126	18-1505-15	129	18-1562-45	133
18-1401-04	116	18-1461-15	126	18-1506-15	129	18-1562-50	133
18-1401-05	116	18-1461-18	126	18-1502-18	129	18-1562-55	133
18-1403-01	117	18-1462-12	126	18-1503-18	129	18-1562-60	133
18-1403-02	117	18-1462-15	126	18-1504-18	129	19-1620	135
18-1404-01	117	18-1462-18	126	18-1505-18	129	19-1621	135
18-1404-02	117	18-1470-12	126	18-1506-18	129	19-1622	135
18-1404-03	117	18-1470-15	126	18-1502-20	129	19-1625	135
18-1404-04	117	18-1470-18	126	18-1503-20	129	19-1628	136
18-1406-01	118	18-1471-12	126	18-1504-20	129	19-1629	136
18-1406-02	118	18-1471-15	126	18-1505-20	129	19-1630	136
18-1407-24	118	18-1471-18	126	18-1506-20	129	19-1631	136
18-1410-01	118	18-1472-12	126	18-1512-15	130	19-1632	136
18-1410-02	118	18-1472-15	126	18-1513-15	130	19-1633	137
18-1410-03	118	18-1472-18	126	18-1514-15	130	19-1634	137
18-1411-20	119	18-1480-01	127	18-1515-15	130	19-1635	137
18-1415-01	119	18-1480-02	127	18-1516-15	130	19-1636	137

Cat. Nr. Cat.-No Kat.-Nr. No. ref.	Biz. Page Seite Pagina	Cat. Nr. Cat.-No Kat.-Nr. No. ref.	Biz. Page Seite Pagina	Cat. Nr. Cat.-No Kat.-Nr. No. ref.	Biz. Page Seite Pagina	Cat.-No Kat.-Nr. No. ref.	Page Seite Pagina
19.1638	137	20.1774	141	20.1880	145	20.1968	154
19.1639	137	20.1775	141	20.1881	145	20.1969	154
19.1640	137	20.1776	141	20.1882	145	20.1970	154
19.1641	138	20.1777-01	141	20.1884	145	20.1791-SC	155
19.1642	138	20.1777-02	141	20.1885	145	20.1793-SC	155
19.1643	138	20.1780	141	20.1886	145	20.1796-SC	155
19.1644	138	20.1781	141	20.1887-01	145	20.1798-SC	155
19.1650	138	20.1783	141	20.1887-02	145	20.1801-SC	155
19.1651	138	20.1785	141	20.1888	145	20.1802-SC	155
19.1652	138	20.1786	141	20.1889	145	20.1803-SC	155
19.1653	138	20.1791	142	20.1890	145	20.1804-SC	155
20.1701	140	20.1792	142	20.1891	145	20.1817-SC	155
20.1702	140	20.1793	142	20.1892	145	20.1818-SC	155
20.1703	140	20.1794	142	20.1893	146	20.1821-SC	156
20.1704	140	20.1796	142	20.1895	146	20.1822-SC	156
20.1705	140	20.1797	142	20.1896	146	20.1851-SC	156
20.1706	140	20.1798	142	20.1898	146	20.1852-SC	156
20.1707	140	20.1799	142	20.1899	146	20.1880-SC	157
20.1708	140	20.1801	142	20.1901	146	20.1884-SC	157
20.1709	140	20.1802	142	20.1902	146	20.1888-SC	157
20.1711	140	20.1802-21	142	20.1904	146	20.1889-SC	157
20.1712	140	20.1803	142	20.1905-16	146	20.1979-SC	157
20.1713	140	20.1804	142	20.1905-18	146	20.1980-SC	157
20.1714	140	20.1804-21	142	20.1906-16	146	20.1981-SC	157
20.1715	140	20.1806	142	20.1906-18	146	20.7458-SC	157
20.1716	140	20.1808	142	20.1907	146	20.7459-SC	157
20.1717	140	20.1810	142	20.1908	147	20.7496-SC	157
20.1718	140	20.1811	142	20.1909	147	20.7497-SC	157
20.1719	140	20.1812	143	20.1910	147	21.1971	159
20.1721	140	20.1813	143	20.1910-18	147	21.1972	159
20.1722	140	20.1814	143	20.1911	147	21.1973	159
20.1723	140	20.1815	143	20.1912	148	21.1974	159
20.1724	140	20.1817	143	20.1913	148	21.1975	159
20.1725	140	20.1818	143	20.1914	148	21.1976	159
20.1726	140	20.1819	143	20.1915	148	21.1976G	159
20.1727	140	20.1820	143	20.1916	148	21.1977	159
20.1728	140	20.1821	144	20.1917	148	21.1978	159
20.1729	140	20.1822	144	20.1918	148	21.1979	159
20.1731	140	20.1823	144	20.1919	148	21.1980	159
20.1732	140	20.1824	144	20.1920	149	21.1981	159
20.1733	140	20.1825	144	20.1922-01	149	21.1982	159
20.1734	140	20.1826	144	20.1922-02	149	21.1983	159
20.1735	140	20.1827	144	20.1922-03	149	21.1984	160
20.1736	140	20.1831	144	20.1922-04	149	21.1985	160
20.1737	140	20.1832	144	20.1923	150	21.1986S	160
20.1738	140	20.1833	144	20.1924	150	21.1987S	160
20.1739	140	20.1834	144	20.1925	150	21.1988	160
20.1741	140	20.1835	144	20.1926	150	21.1989	160
20.1742	140	20.1836	144	20.1927	150	21.1990	161
20.1743	140	20.1837	144	20.1928	150	21.1995	161
20.1744	140	20.1841	144	20.1929	151	21.1996	161
20.1745	140	20.1842	144	20.1930	151	21.1997	161
20.1746	140	20.1843	144	20.1931	151	21.1998	161
20.1747	140	20.1844	144	20.1932	151	21.1999	161
20.1748	140	20.1845	144	20.1933	151	21.2000	161
20.1749	140	20.1846	144	20.1934	151	21.2021	161
20.1751	140	20.1847	144	20.1935	152	21.2022	161
20.1752	140	20.1851	144	20.1937	152	21.2024	161
20.1753	140	20.1852	144	20.1940	152	21.2028	162
20.1754	140	20.1853	144	20.1941	152	21.2032	162
20.1755	140	20.1854	144	20.1942	152	21.2033	162
20.1756	140	20.1855	144	20.1943	152	21.2034	162
20.1757	140	20.1856	144	20.1945	153	21.2036	163
20.1758	140	20.1857	144	20.1946	153	21.2037	163
20.1759	140	20.1861	144	20.1947	153	22.2001	165
20.1761	140	20.1862	144	20.1948	153	22.2002	165
20.1762	140	20.1863	144	20.1949	153	22.2003	165
20.1763	140	20.1864	144	20.1950	153	22.2004	165
20.1764	140	20.1865	144	20.1951	153	22.2005	165
20.1765	140	20.1866	144	20.1952	153	22.2006	165
20.1766	140	20.1867	144	20.1954	153	22.2007	165
20.1767	140	20.1871	144	20.1955	153	22.2008	166
20.1768	140	20.1872	144	20.1956-15	153	22.2009	166
20.1769	140	20.1873	144	20.1961	154	22.2010	166
20.1770	140	20.1874	144	20.1963	154	22.2011	166
20.1771	140	20.1875	144	20.1965	154	22.2012	166
20.1772	140	20.1876	144	20.1966	154	22.2013	166
20.1773	141	20.1877	144	20.1967	154	22.2014-14	166

Cat. Nr. Cat.-No Kat.-Nr. No. ref.	Biz. Page Seite Pagina	Cat. Nr. Cat.-No Kat.-Nr. No. ref.	Biz. Page Seite Pagina	Cat. Nr. Cat.-No Kat.-Nr. No. ref.	Biz. Page Seite Pagina	Cat.-No Kat.-Nr. No. ref.	Page Seite Pagina
22.2014-16	166	22.2236	172	23.2312	182	23.2440-06	189
22.2014-18	166	22.2237	172	23.2314	182	23.2440-07	189
22.2014-20	166	22.2238	172	23.2314	182	23.2440-08	189
22.2014-25	166	22.2239	172	23.2318	182	23.2440-09	189
22.2015	166	22.2240	173	23.2319	182	23.2440-10	189
22.2016	166	22.2241	173	23.2322	183	23.2440-11	189
22.2017	166	22.2242	173	23.2324	183	23.2440-12	189
22.2018	166	22.2244	173	23.2329	183	23.2440-13	189
22.2019	166	22.2245	173	23.2330	183	23.2440-14	189
22.2095-14	167	22.2246	173	23.2331	183	23.2440-15	189
22.2096-14	167	22.2247	174	23.2332	183	23.2440-16	189
22.2097-14	167	22.2248	174	23.2333	183	23.2441-30	189
22.2098-14	167	22.2250	174	23.2334	183	23.2441-20	189
22.2099-14	167	22.2251	174	23.2335	183	23.2441-00	189
22.2099-18	167	22.2252	174	23.2351	183	23.2441-01	189
22.2099-21	167	22.2253-11	174	23.2352	183	23.2441-02	189
22.2100-14	167	22.2253-16	174	23.2353	183	23.2441-03	189
22.2100-18	167	22.2254	175	23.2354	183	23.2441-04	189
22.2100-21	167	22.2255	175	23.2355	183	23.2441-05	189
22.2101-14	167	22.2256	175	23.2356-01	184	23.2441-06	189
22.2101-18	167	22.2257	175	23.2356-02	184	23.2441-07	189
22.2101-21	167	22.2258	175	23.2357	184	23.2441-08	189
22.2102-14	167	22.2260	176	23.2358	184	23.2441-09	189
22.2102-18	167	22.2261	176	23.2257N	184	23.2441-10	189
22.2102-21	167	22.2262	176	23.2258N	184	23.2441-11	189
22.2104	167	22.2263	176	23.2359	184	23.2441-12	189
22.2105	167	22.2264	176	23.2360	184	23.2441-13	189
22.2106	167	22.2265	176	23.2361	184	23.2441-14	189
22.2110	167	22.2268-22	176	23.2362	184	23.2441-15	189
22.2111	167	22.2268-23	176	23.2363	184	23.2441-16	189
22.2113	168	22.2269	176	23.2365	185	23.2442-30	189
22.2114	168	22.2270	177	23.2367	185	23.2442-20	189
22.2115	168	22.2271	177	23.2370	185	23.2442-00	189
22.2116	168	22.2272	177	23.2372	185	23.2442-01	189
22.2117	168	22.2273	177	23.2373	185	23.2442-02	189
22.2118	168	22.2274	177	23.2375	185	23.2442-03	189
22.2119	168	22.2275	177	23.2377	185	23.2442-04	189
22.2192	168	22.2276	177	23.2382	186	23.2442-05	189
22.2199	168	22.2277	177	23.2384	186	23.2442-06	189
22.2200	168	22.2278-01	177	23.2385	186	23.2442-07	189
22.2201	168	22.2278-02	177	23.2386	186	23.2442-08	189
22.2202	168	22.2279-01	177	23.2387	186	23.2442-09	189
22.2203	168	22.2279-02	177	23.2388	186	23.2442-10	189
22.2204	168	22.2280	178	23.2389	186	23.2442-11	189
22.2205	168	22.2281	178	23.2390	186	23.2442-12	189
22.2206	169	22.2282	178	23.2391	186	23.2442-13	189
22.2207	169	22.2283	178	23.2392	186	23.2442-14	189
22.2208	169	22.2284	178	23.2393	186	23.2442-15	189
22.2209	169	22.2285	178	23.2394	186	23.2442-16	189
22.2210	169	22.2286	178	23.2397	186	23.2443-30	189
22.2211	170	22.2287	178	23.2398	186	23.2443-20	189
22.2212	170	22.2280F	178	23.2388K	186	23.2443-00	189
22.2213	170	22.2281F	178	23.2389K	186	23.2443-01	189
22.2214	170	22.2282F	178	23.2405-14	187	23.2443-02	189
22.2215	170	22.2283F	178	23.2405-18	187	23.2443-03	189
22.2216	170	22.2284F	178	23.2405-21	187	23.2443-04	189
22.2217	170	22.2285F	178	23.2406-14	187	23.2443-05	189
22.2218	170	22.2286F	178	23.2406-18	187	23.2443-06	189
22.2228	170	22.2287F	178	23.2406-21	187	23.2443-07	189
22.2216D	170	22.2288	178	23.2407-14	187	23.2443-08	189
22.2217D	170	22.2289-01	178	23.2408-14	187	23.2443-09	189
22.2218D	170	22.2289-02	178	23.2419-14	187	23.2443-10	189
22.2228D	170	22.2290	179	23.2420-14	187	23.2443-11	189
22.2219	171	22.2291	179	23.2401	187	23.2443-12	189
22.2220	171	22.2292	179	23.2402	187	23.2443-13	189
22.2221	171	22.2293	179	23.2410	187	23.2443-14	189
22.2222	171	22.2294-16	179	23.2412	187	23.2443-15	189
22.2223	171	22.2296-01	180	23.2413	187	23.2443-16	189
22.2224	171	22.2296-02	180	23.2417	187	23.2446-30	189
22.2225	171	22.2296-03	180	23.2418	187	23.2446-20	189
22.2226	171	22.2297-18	180	23.2440-30	189	23.2446-00	189
22.2227	171	22.2298-16	180	23.2440-20	189	23.2446-01	189
22.2231	172	22.2298-18	180	23.2440-00	189	23.2446-02	189
22.2232	172	23.2301	182	23.2440-01	189	23.2446-03	189
22.2233-17	172	23.2305	182	23.2440-02	189	23.2446-04	189
22.2233-20	172	23.2306	182	23.2440-03	189	23.2446-05	189
22.2234	172	23.2310	182	23.2440-04	189	23.2446-06	189
22.2235	172	23.2311	182	23.2440-05	189	23.2446-07	189

Cat. Nr. Cat.-No Kat.-Nr. No. ref.	Biz. Page Seite Pagina	Cat. Nr. Cat.-No Kat.-Nr. No. ref.	Biz. Page Seite Pagina	Cat. Nr. Cat.-No Kat.-Nr. No. ref.	Biz. Page Seite Pagina	Cat.-No Kat.-Nr. No. ref.	Page Seite Pagina
23.2446-08	189	23.2452-30	190	23.2466-30	191	23.2473-08	192
23.2446-09	189	23.2452-20	190	23.2466-20	191	23.2474-20	192
23.2446-10	189	23.2452-00	190	23.2466-00	191	23.2474-00	192
23.2446-11	189	23.2452-01	190	23.2466-01	191	23.2474-01	192
23.2446-12	189	23.2452-02	190	23.2466-02	191	23.2474-02	192
23.2446-13	189	23.2452-03	190	23.2466-03	191	23.2474-03	192
23.2446-14	189	23.2452-04	190	23.2466-04	191	23.2474-04	192
23.2446-15	189	23.2452-05	190	23.2466-05	191	23.2474-05	192
23.2446-16	189	23.2452-06	190	23.2466-06	191	23.2474-06	192
23.2447-30	189	23.2452-07	190	23.2466-07	191	23.2474-07	192
23.2447-20	189	23.2452-08	190	23.2466-08	191	23.2474-08	192
23.2447-00	189	23.2452-09	190	23.2466-09	191	23.2475-20	192
23.2447-01	189	23.2453-30	190	23.2466-10	191	23.2475-00	192
23.2447-02	189	23.2453-20	190	23.2466-11	191	23.2475-01	192
23.2447-03	189	23.2453-00	190	23.2466-12	191	23.2475-02	192
23.2447-04	189	23.2453-01	190	23.2466-13	191	23.2475-03	192
23.2447-05	189	23.2453-02	190	23.2466-14	191	23.2475-04	192
23.2447-06	189	23.2453-03	190	23.2466-15	191	23.2475-05	192
23.2447-07	189	23.2453-04	190	23.2466-16	191	23.2475-06	192
23.2447-08	189	23.2453-05	190	23.2467-30	191	23.2475-07	192
23.2447-09	189	23.2453-06	190	23.2467-20	191	23.2475-08	192
23.2447-10	189	23.2453-07	190	23.2467-00	191	23.2476-20	192
23.2447-11	189	23.2453-08	190	23.2467-01	191	23.2476-00	192
23.2447-12	189	23.2453-09	190	23.2467-02	191	23.2476-01	192
23.2447-13	189	23.2454-30	190	23.2467-03	191	23.2476-02	192
23.2447-14	189	23.2454-20	190	23.2467-04	191	23.2476-03	192
23.2447-15	189	23.2454-00	190	23.2467-05	191	23.2476-04	192
23.2447-16	189	23.2454-01	190	23.2467-06	191	23.2476-05	192
23.2448-30	189	23.2454-02	190	23.2467-07	191	23.2476-06	192
23.2448-20	189	23.2454-03	190	23.2467-08	191	23.2476-07	192
23.2448-00	189	23.2454-04	190	23.2467-09	191	23.2476-08	192
23.2448-01	189	23.2454-05	190	23.2467-10	191	23.2477-20	192
23.2448-02	189	23.2454-06	190	23.2467-11	191	23.2477-00	192
23.2448-03	189	23.2454-07	190	23.2467-12	191	23.2477-01	192
23.2448-04	189	23.2454-08	190	23.2467-13	191	23.2477-02	192
23.2448-05	189	23.2454-09	190	23.2467-14	191	23.2477-03	192
23.2448-06	189	23.2457-01	190	23.2467-15	191	23.2477-04	192
23.2448-07	189	23.2457-02	190	23.2467-16	191	23.2477-05	192
23.2448-08	189	23.2457-03	190	23.2470-20	192	23.2477-06	192
23.2448-09	189	23.2457-04	190	23.2470-00	192	23.2477-07	192
23.2448-10	189	23.2457-05	190	23.2470-01	192	23.2477-08	192
23.2448-11	189	23.2457-06	190	23.2470-02	192	23.2480-00	193
23.2448-12	189	23.2458-01	190	23.2470-03	192	23.2480-01	193
23.2448-13	189	23.2458-02	190	23.2470-04	192	23.2480-02	193
23.2448-14	189	23.2458-03	190	23.2470-05	192	23.2480-03	193
23.2448-15	189	23.2458-04	190	23.2470-06	192	23.2480-04	193
23.2448-16	189	23.2458-05	190	23.2470-07	192	23.2480-05	193
23.2449-30	189	23.2458-06	190	23.2470-08	192	23.2481-00	193
23.2449-20	189	23.2459-01	190	23.2471-20	192	23.2481-01	193
23.2449-00	189	23.2459-02	190	23.2471-00	192	23.2481-02	193
23.2449-01	189	23.2459-03	190	23.2471-01	192	23.2481-03	193
23.2449-02	189	23.2459-04	190	23.2471-02	192	23.2481-04	193
23.2449-03	189	23.2459-05	190	23.2471-03	192	23.2481-05	193
23.2449-04	189	23.2459-06	190	23.2471-04	192	23.2482-00	193
23.2449-05	189	23.2460-01	190	23.2471-05	192	23.2482-01	193
23.2449-06	189	23.2460-02	190	23.2471-06	192	23.2482-02	193
23.2449-07	189	23.2460-03	190	23.2471-07	192	23.2482-03	193
23.2449-08	189	23.2460-04	190	23.2471-08	192	23.2482-04	193
23.2449-09	189	23.2460-05	190	23.2472-20	192	23.2482-05	193
23.2449-10	189	23.2460-06	190	23.2472-00	192	23.2483-00	193
23.2449-11	189	23.2463-30	191	23.2472-01	192	23.2483-01	193
23.2449-12	189	23.2463-20	191	23.2472-02	192	23.2483-02	193
23.2449-13	189	23.2463-00	191	23.2472-03	192	23.2483-03	193
23.2449-14	189	23.2463-01	191	23.2472-04	192	23.2483-04	193
23.2449-15	189	23.2463-02	191	23.2472-05	192	23.2483-05	193
23.2449-16	189	23.2463-03	191	23.2472-06	192	23.2484-00	193
23.2451-30	190	23.2463-04	191	23.2472-07	192	23.2484-01	193
23.2451-20	190	23.2463-05	191	23.2472-08	192	23.2484-02	193
23.2451-00	190	23.2463-06	191	23.2473-20	192	23.2484-03	193
23.2451-01	190	23.2464-30	191	23.2473-00	192	23.2484-04	193
23.2451-02	190	23.2464-20	191	23.2473-01	192	23.2484-05	193
23.2451-03	190	23.2464-00	191	23.2473-02	192	23.2485-00	193
23.2451-04	190	23.2464-01	191	23.2473-03	192	23.2485-01	193
23.2451-05	190	23.2464-02	191	23.2473-04	192	23.2485-02	193
23.2451-06	190	23.2464-03	191	23.2473-05	192	23.2485-03	193
23.2451-07	190	23.2464-04	191	23.2473-06	192	23.2485-04	193
23.2451-08	190	23.2464-05	191	23.2473-07	192	23.2485-05	193
23.2451-09	190	23.2464-06	191			23.2486-20	193

Cat. Nr. Cat.-No Kat.-Nr. No. ref.	Biz. Page Seite Pagina	Cat. Nr. Cat.-No Kat.-Nr. No. ref.	Biz. Page Seite Pagina	Cat. Nr. Cat.-No Kat.-Nr. No. ref.	Biz. Page Seite Pagina	Cat.-No Kat.-Nr. No. ref.	Page Seite Pagina
23.2486-00	193	23.2555-02	203	24.2652	212	24.2683	218
23.2486-01	193	23.2556-01	203	24.2655	212	24.2689	219
23.2486-02	193	23.2556-02	203	24.2656	212	24.2690	219
23.2486-03	193	23.2557-22	203	24.2657	212	24.2691	219
23.2487-01	193	23.2560-01	204	24.2660	213	24.2692-01	220
23.2487-02	193	23.2560-02	204	24.2661	213	24.2692-02	220
23.2487-03	193	23.2560-03	204	24.2662-08	214	24.2692-05	220
23.2487-04	193	23.2560-04	204	24.2662-10	214	24.2692-10	220
23.2487-05	193	23.2561-01	205	24.2662-12	214	24.2692-20	220
23.2488-20	193	23.2561-02	205	24.2662-14	214	24.2692-50	220
23.2488-00	193	23.2562-01	205	24.2662-16	214	24.2693-01	220
23.2488-01	193	23.2562-02	205	24.2662-18	214	24.2693-02	220
23.2488-02	193	23.2562-03	205	24.2663-08	214	24.2693-05	220
23.2488-03	193	23.2563-01	206	24.2663-10	214	24.2693-10	220
23.2490-01	194	23.2563-02	206	24.2663-12	214	24.2693-20	220
23.2490-02	194	23.2564-25	206	24.2663-14	214	24.2693-50	220
23.2490-03	194	23.2565-01	206	24.2663-16	214	24.2694-01	220
23.2490-04	194	23.2565-02	206	24.2663-18	214	24.2694-02	220
23.2490-05	194	23.2565-03	206	24.2664-08	214	24.2694-05	220
23.2490-06	194	23.2566-18	206	24.2664-10	214	24.2694-10	220
23.2491-01	194	23.2566-27	206	24.2664-12	214	24.2694-20	220
23.2491-02	194	23.2570-01	207	24.2664-14	214	24.2694-50	220
23.2491-03	194	23.2570-02	207	24.2664-16	214	24.2695-01	220
23.2491-04	194	23.2570-03	207	24.2664-18	214	24.2695-02	220
23.2491-05	194	23.2570-04	207	24.2668-12	215	24.2695-05	220
23.2491-06	194	23.2571-01	207	24.2668-15	215	24.2695-10	220
23.2492-01	194	23.2571-02	207	24.2669-00	215	24.2695-20	220
23.2492-02	194	23.2571-03	207	24.2669-01	215	24.2695-50	220
23.2492-03	194	23.2571-04	207	24.2669-04	215	24.2696-02	221
23.2492-04	194	23.2572-01	208	24.2669-06	215	24.2696-05	221
23.2493-01	194	23.2572-02	208	24.2669-08	215	24.2696-10	221
23.2493-02	194	23.2572-03	208	24.2670-06	215	24.2697-02	221
23.2493-03	194	23.2572-04	208	24.2670-07	215	24.2697-05	221
23.2493-04	194	24.2603	210	24.2670-08	215	24.2697-10	221
23.2500	195	24.2604	210	24.2670-09	215	24.2698-05	221
23.2505	195	24.2606	210	24.2670-10	215	24.2698-07	221
23.2508	195	24.2607	210	24.2670-11	215	24.2698-10	221
23.2509	195	24.2610	210	24.2670-12	215	24.2698-15	221
23.2511	195	24.2611	210	24.2670-15	215	24.2698-20	221
23.2515	195	24.2612	210	24.2671-09	216	24.2698-25	221
23.2516	196	24.2613	210	24.2671-15	216	24.2699-05	221
23.2518	196	24.2614	210	24.2672-00	216	24.2699-07	221
23.2519-01	196	24.2615	210	24.2672-06	216	24.2699-10	221
23.2519-02	196	24.2616	210	24.2672-07	216	24.2699-15	221
23.2519-03	196	24.2620	210	24.2672-08	216	24.2699-20	221
23.2519-04	196	24.2621	210	24.2672-09	216	24.2699-25	221
23.2519-05	196	24.2622	210	24.2672-10	216	25.2701	223
23.2519-06	196	24.2623	210	24.2672-11	216	25.2703	223
23.2519-07	196	24.2624	210	24.2672-12	216	25.2704	223
23.2519-08	196	24.2625	210	24.2672-15	216	25.2706	223
23.2530-20	197	24.2626	210	24.2673-05	216	25.2708	223
23.2531-20	197	24.2630	210	24.2673-06	216	25.2710	223
23.2532-20	197	24.2631	210	24.2673-07	216	25.2715-14	223
23.2533-20	197	24.2632	210	24.2673-08	216	25.2715-16	223
23.2534-20	198	24.2633	210	24.2673-09	216	25.2715-18	223
23.2535-20	198	24.2634	210	24.2673-10	216	25.2715-20	223
23.2536-20	198	24.2635	210	24.2674	217	25.2711	223
23.2537-20	198	24.2636	210	24.2675-03	217	25.2713	223
23.2538-21	199	24.2637-07	211	24.2675-06	217	25.2714	223
23.2539-21	199	24.2637-09	211	24.2676-01	217	25.2716	223
23.2540-21	199	24.2637-11	211	24.2676-02	217	25.2718	223
23.2541-21	199	24.2637-12	211	24.2676-03	217	25.2720	223
23.2542-24	200	24.2640-10	211	24.2676-04	217	25.2725	223
23.2543-24	200	24.2640-12	211	24.2676-05	217	25.2731	223
23.2544-27	200	24.2640-14	211	24.2676-06	217	25.2733	223
23.2545-27	200	24.2640-16	211	24.2676-07	217	25.2734	223
23.2546-27	201	24.2640-18	211	24.2676-08	217	25.2736	223
23.2547-27	201	24.2640-20	211	24.2677-14	217	25.2738	223
23.2548-28	201	24.2640-22	211	24.2677-18	217	25.2740	223
23.2549-28	201	24.2640-24	211	24.2678-01	217	25.2745	223
23.2550-01	202	24.2640-26	211	24.2678-02	217	25.2751	223
23.2550-02	202	24.2640-28	211	24.2678-03	217	25.2753	223
23.2551-01	202	24.2641-08	211	24.2679-00	217	25.2754	223
23.2551-02	202	24.2641-10	211	24.2679-01	217	25.2756	223
23.2552-32	202	24.2642-01	212	24.2680A	218	25.2760	223
23.2553-21	202	24.2642-02	212	24.2680	218	25.2761	223
23.2554-15	203	24.2644	212	24.2681	218	25.2763	223
23.2555-01	203	24.2651	212	24.2682	218	25.2764	223

Cat. Nr. Cat.-No Kat.-Nr. No. ref.	Biz. Page Seite Pagina	Cat. Nr. Cat.-No Kat.-Nr. No. ref.	Biz. Page Seite Pagina	Cat. Nr. Cat.-No Kat.-Nr. No. ref.	Biz. Page Seite Pagina	Cat.-No Kat.-Nr. No. ref.	Page Seite Pagina
25.2766	223	26.2920-10	230	26.3079	237	26.3136-26	248
25.2768	223	26.2920-12	230	26.3080	237	26.3137-25	248
25.2770	223	26.2920-14	230	26.3085	237	26.3138-01	249
25.2773	223	26.2920-16	230	26.3086	237	26.3138-02	249
25.2774	223	26.2920-18	230	26.3087	237	26.3138-03	249
25.2776	223	26.2921-08	230	26.3088	237	26.3139-01	250
25.2780	223	26.2921-10	230	26.3089	237	26.3139-02	250
25.2781	223	26.2921-12	230	26.3090	237	26.3140-25	250
25.2782-13	224	26.2921-14	230	26.3091	237	26.3141	251
25.2782-18	224	26.2921-16	230	26.3092	237	26.3142	251
25.2785	224	26.2921-18	230	26.3093	237	26.3143	251
25.2786-01	224	26.2922	231	26.3094	237	26.3144-08	251
25.2786-02	224	26.2923	231	26.3095	237	26.3144-10	251
25.2786-03	224	26.2924-01	231	26.3096	237	26.3144-12	251
25.2786-04	224	26.2924-02	231	26.3097	237	26.3144-13	251
25.2800-13	225	26.2925-10	231	26.3098	237	26.3144-14	251
25.2800-14	225	26.2925-20	231	26.3081	238	26.3144-16	251
25.2812-09	225	26.2925-17	231	26.3082	238	26.3144-18	251
25.2814-01	225	26.2925-22	231	26.3083	238	26.3145-08	252
25.2814-09	225	26.2926-02	232	26.3084	238	26.3145-10	252
25.2814-12	225	26.2926-03	232	26.3099-01	238	26.3145-12	252
25.2816-11	225	26.2926-04	232	26.3099-02	238	26.3145-14	252
25.2818-12	225	26.2926-06	232	26.3099-03	238	26.3145-16	252
25.2818-15	225	26.2927-02	232	26.3100	239	26.3145-18	252
25.2818-18	225	26.2927-03	232	26.3101	239	26.3146-16	253
25.2820-18	225	26.2927-04	232	26.3102	239	26.3146-25	253
25.2822	225	26.2927-06	232	26.3103	239	26.3146-50	253
25.2850-00	226	26.2930-01	232	26.3104	239	26.3149-01	254
25.2850-70	226	26.2930-02	232	26.3105	239	26.3149-02	254
25.2850-02	226	26.2931	232	26.3106	240	26.3149-03	254
25.2850-50	226	26.3001	233	26.3106-01	240	26.3149-04	254
25.2850-60	226	26.3002	233	26.3106-02	240	26.3151	255
25.2850-03	226	26.3003	233	26.3107-01	240	26.3152	255
25.2850-06	226	26.3004	233	26.3107-02	240	26.3153-01	255
25.2850-09	226	26.3006	233	26.3108-01	240	26.3153-02	255
25.2850-12	226	26.3011	233	26.3108-02	240	26.3154	255
25.2850-15	226	26.3012	233	26.3108-03	240	26.3155	255
25.2852-50	226	26.3013	233	26.3109-01	241	26.3156	255
25.2852-02	226	26.3014	233	26.3109-02	241	26.3157	255
25.2852-03	226	26.3016	233	26.3109-03	241	26.3158	255
25.2852-04	226	26.3021	233	26.3110-01	241	26.3160	256
25.2852-06	226	26.3022	233	26.3110-02	241	26.3161	256
25.2852-07	226	26.3023	233	26.3110-03	241	26.3162	256
25.2852-08	226	26.3024	233	26.3111	242	26.3164	256
25.2852-10	226	26.3026	233	26.3112	242	26.3165	256
25.2852-12	226	26.3031	233	26.3113	242	26.3166	257
25.2852-14	226	26.3032	233	26.3114	242	26.3167	257
26.2901	228	26.3033	233	26.3115-01	242	26.3168	257
26.2902	228	26.3034	233	26.3115-02	242	26.3169	257
26.2903	228	26.3036	233	26.3115-03	242	26.3170-00	257
26.2904	228	26.3040	234	26.3116-80	243	26.3171	257
26.2911	228	26.3041	234	26.3116-85	243	26.3172	257
26.2912	228	26.3043	234	26.3118-01	243	26.3173	257
26.2913	228	26.3051	234	26.3118-02	243	26.3176-01	258
26.2914	228	26.3052	234	26.3118-03	243	26.3176-02	258
26.2915-01	228	26.3053	234	26.3119-01	244	26.3177-01	258
26.2915-02	228	26.3054	234	26.3119-02	244	26.3177-02	258
26.2915-03	228	26.3056	234	26.3119-03	244	26.3178-01	258
26.2915-04	228	26.3061	234	26.3119-04	244	26.3178-02	258
26.2916-01	228	26.3062	234	26.3119-05	244	26.3179-01	258
26.2916-02	228	26.3063	234	26.3119-06	244	26.3179-02	258
26.2916-03	228	26.3064	234	26.3120-01	245	26.3181	259
26.2916-04	228	26.3066	234	26.3120-02	245	26.3183	259
26.2917-01	229	26.3067	235	26.3120-03	245	26.3186	259
26.2917-02	229	26.3068	235	26.3120-04	245	26.3189	259
26.2917-03	229	26.3069-03	235	26.3121	246	26.3191	259
26.2917-04	229	26.3069-04	235	26.3122	246	26.3193	259
26.2918-01	229	26.3070-20	235	26.3123	246	26.3196	259
26.2918-02	229	26.3074-04	236	26.3124	246	26.3199	259
26.2918-03	229	26.3074-05	236	26.3125	246	26.3202-01	259
26.2918-04	229	26.3074-06	236	26.3126	246	26.3202-02	259
26.2919-01	229	26.3074-07	236	26.3127	247	26.3203	259
26.2919-02	229	26.3075-55	237	26.3128	247	26.3204-01	259
26.2919-03	229	26.3075-60	237	26.3129	247	26.3204-02	259
26.2919-04	229	26.3075-63	237	26.3132	247	HB 3205	260
26.2919-05	229	26.3076	237	26.3133	247	26.3206-01	260
26.2919-06	229	26.3077	237	26.3135-01	248	26.3206-02	260
26.2920-08	230	26.3078	237	26.3135-02	248	26.3207	260

Cat. Nr. Cat.-No Kat.-Nr. No. ref.	Biz. Page Seite Pagina	Cat. Nr. Cat.-No Kat.-Nr. No. ref.	Biz. Page Seite Pagina	Cat. Nr. Cat.-No Kat.-Nr. No. ref.	Biz. Page Seite Pagina	Cat.-No Kat.-Nr. No. ref.	Page Seite Pagina
26.3208	260	26.3340-45	272	27.3428-35	282	27.3461-08	291
26.3210-01	261	26.3340-70	272	27.3428-36	282	27.3461-10	291
26.3210-02	261	26.3342	273	27.3428-40	282	27.3461-12	291
26.3211-01	261	26.3343-01	273	27.3428-45	282	27.3461-14	291
26.3211-02	261	26.3343-02	273	27.3428-65	282	27.3461-16	291
26.3212-01	261	26.3344-01	273	27.3430-01	283	27.3462-03	291
26.3212-02	261	26.3344-02	273	27.3430-02	283	27.3462-04	291
26.3213-01	261	26.3344-03	273	27.3430-03	283	27.3462-05	291
26.3213-02	261	26.3344-04	273	27.3430-04	283	27.3462-06	291
26.3216	261	26.3345-09	274	27.3430-05	283	27.3462-08	291
26.3217	261	26.3345-11	274	27.3431-01	283	27.3462-10	291
26.3218	261	26.3345-14	274	27.3431-02	283	27.3462-12	291
26.3219	261	26.3345-18	274	27.3432-01	283	27.3462-14	291
26.3220-01	262	26.3346-18	274	27.3432-02	283	27.3462-16	291
26.3220-02	262	26.3348	274	27.3433-18	283	27.3463-02	291
26.3221-01	262	26.3349	274	27.3433-19	283	27.3463-03	291
26.3221-02	262	26.3350	275	27.3434-01	283	27.3463-04	291
26.3222-01	262	26.3351	275	27.3434-02	283	27.3463-05	291
26.3222-02	262	26.3360	276	27.3438-00	284	27.3463-06	291
26.3223-01	263	26.3361	276	27.3438-03	284	27.3463-07	291
26.3223-02	263	26.3362	276	27.3439-00	284	27.3463-08	291
26.3224-01	263	26.3365	276	27.3440-00	284	27.3464-02	291
26.3224-02	263	26.3366	276	27.3440-01	284	27.3464-03	291
26.3225	264	26.3367	276	27.3441-00	285	27.3464-04	291
26.3226-00	264	26.3368-06	276	27.3441-01	285	27.3464-05	291
26.3226-01	264	26.3368-09	276	27.3442-00	285	27.3464-06	291
26.3226-02	264	26.3368-12	276	27.3442-01	285	27.3464-07	291
26.3226-03	264	26.3368-17	276	27.3443-00	286	27.3464-08	291
26.3228	264	26.3368-20	276	27.3443-27	286	27.3465-02	291
26.3305-28	265	26.3368-25	276	27.3443-01	286	27.3465-03	291
26.3305-30	265	26.3369	276	27.3443-02	286	27.3465-04	291
26.3307	265	26.3371	277	27.3443-03	286	27.3465-05	291
26.3308	265	26.3372-20	277	27.3443-04	286	27.3465-06	291
26.3309	266	26.3372-30	277	27.3443-05	286	27.3465-07	291
26.3310	266	26.3372-40	277	27.3443-06	286	27.3465-08	291
26.3311	266	26.34	277	27.3443-07	286	27.3466-02	291
26.3312	266	26.3376-30	277	27.3443-08	286	27.3466-03	291
26.3313-18	266	26.3376-40	277	27.3443-09	286	27.3466-04	291
26.3313-27	266	26.3376-50	277	27.3444-00	287	27.3466-05	291
26.3313-38	266	26.3376-60	277	27.3444-01	287	27.3466-06	291
26.3313-40	266	26.3376-70	277	27.3444-02	287	27.3466-07	291
26.3313-45	266	27.3400-00	279	27.3444-03	287	27.3466-08	291
26.3313-60	266	27.3400-12	279	27.3444-04	287	27.3467-04	292
26.3315	267	27.3400-15	279	27.3444-05	287	27.3467-06	292
26.3316	267	27.3400-18	279	27.3444-06	287	27.3467-08	292
26.3317	267	27.3401-00	279	27.3444-07	287	27.3467-10	292
26.3318	267	27.3401-20	279	27.3444-08	287	27.3467-12	292
26.3320	268	27.3402	279	27.3444-09	287	27.3467-14	292
26.3321	268	27.3403-27	279	27.3444-10	287	27.3468-04	292
26.3323	268	27.3403-30	279	27.3444-11	287	27.3468-06	292
26.3324	269	27.3403-34	279	27.3444-12	287	27.3468-08	292
26.3325	269	27.3403-65	279	27.3450-01	288	27.3468-10	292
26.3326-01	269	27.3403-70	279	27.3450-02	288	27.3468-12	292
26.3326-02	269	27.3403-75	279	27.3451-19	288	27.3468-14	292
26.3326-03	269	27.3404-00	280	27.3452-14	288	27.3469-03	292
26.3313-38	270	27.3404-65	280	27.3453-14	288	27.3469-04	292
26.3330-00	270	27.3404-66	280	27.3454-01	289	27.3469-06	292
26.3330-10	270	27.3404-68	280	27.3454-02	289	27.3469-08	292
26.3331-00	270	27.3405-35	280	27.3454-03	289	27.3469-10	292
26.3335-45	270	27.3406-00	280	27.3454-04	289	27.3469-12	292
26.3335-50	270	27.3406-06	280	27.3455-16	289	27.3469-15	292
26.3335-60	270	27.3406-08	280	27.3456-14	289	27.3470-03	292
26.3335-00	271	27.3406-12	280	27.3457-23	290	27.3470-04	292
26.3335-10	271	27.3406-15	280	27.3458-21	290	27.3470-06	292
26.3335-40	271	27.3406-18	280	27.3459-45	290	27.3470-08	292
26.3335-60	271	27.3407-00	280	27.3459-56	290	27.3470-10	292
26.3335-78	271	27.3410-14	281	27.3459-90	290	27.3470-12	292
26.3335-80	271	27.3411-14	281	27.3460-03	291	27.3470-15	292
26.3335-98	271	27.3412-01	281	27.3460-04	291	27.3471-08	293
26.3335-99	271	27.3412-02	281	27.3460-05	291	27.3471-10	293
26.3336-00	271	27.3413-15	281	27.3460-06	291	27.3471-13	293
26.3336-10	271	27.3420-25	282	27.3460-08	291	27.3471-15	293
26.3336-01	271	27.3420-35	282	27.3460-10	291	27.3471-20	293
26.3336-02	271	27.3421-25	282	27.3460-12	291	27.3471-25	293
26.3336-03	271	27.3422-25	282	27.3460-14	291	27.3471-30	293
26.3336-04	271	27.3428-25	282	27.3460-16	291	27.3471-38	293
26.3340-00	272	27.3428-27	282	27.3461-04	291	27.3471-44	293
26.3340-10	272	27.3428-30	282	27.3461-06	291	27.3471-50	293

Cat. Nr. Cat.-No Kat.-Nr. No. ref.	Biz. Page Seite Pagina	Cat. Nr. Cat.-No Kat.-Nr. No. ref.	Biz. Page Seite Pagina	Cat. Nr. Cat.-No Kat.-Nr. No. ref.	Biz. Page Seite Pagina	Cat.-No Kat.-Nr. No. ref.	Page Seite Pagina
27.3472-08	293	27.3486-15	296	27.3523	300	27.3595-05	305
27.3472-10	293	27.3487-05	296	27.3524	300	27.3595-06	305
27.3472-13	293	27.3487-10	296	27.3525	300	27.3596-30	305
27.3472-15	293	27.3487-15	296	27.3526	300	27.3596-20	305
27.3472-20	293	27.3488-04	297	27.3527	300	27.3596-10	305
27.3472-25	293	27.3488-06	297	27.3528	300	27.3596-01	305
27.3472-30	293	27.3488-08	297	27.3530	300	27.3596-02	305
27.3472-38	293	27.3488-10	297	27.3531	300	27.3596-03	305
27.3472-44	293	27.3488-12	297	27.3532	300	27.3596-04	305
27.3472-50	293	27.3489-04	297	27.3533	300	27.3596-05	305
27.3473-04	293	27.3489-06	297	27.3534	300	27.3596-06	305
27.3473-06	293	27.3489-08	297	27.3535	300	27.3597-30	305
27.3473-03	293	27.3489-10	297	27.3536	300	27.3597-20	305
27.3473-05	293	27.3489-12	297	27.3537	300	27.3597-10	305
27.3476-04	294	27.3490-05	297	27.3538-20	301	27.3597-01	305
27.3477-06	294	27.3490-07	297	27.3538-10	301	27.3597-02	305
27.3477-08	294	27.3490-10	297	27.3538-01	301	27.3597-03	305
27.3477-10	294	27.3490-15	297	27.3538-02	301	27.3597-04	305
27.3477-12	294	27.3490-20	297	27.3540	301	27.3597-05	305
27.3477-15	294	27.3490-25	297	27.3541	301	27.3597-06	305
27.3478-10	294	27.3490-30	297	27.3542	301	27.3598-30	305
27.3478-15	294	27.3491-05	297	27.3543	301	27.3598-20	305
27.3478-20	294	27.3491-07	297	27.3544	301	27.3598-10	305
27.3478-25	294	27.3491-10	297	27.3545	301	27.3598-01	305
27.3479-06	294	27.3491-15	297	27.3546	301	27.3598-02	305
27.3479-08	294	27.3491-20	297	27.3547	301	27.3598-03	305
27.3479-10	294	27.3491-25	297	27.3548	301	27.3598-04	305
27.3479-12	294	27.3491-30	297	27.3550	301	27.3598-05	305
27.3479-15	294	27.3492-03	298	27.3551	301	27.3598-06	305
27.3479-20	294	27.3492-05	298	27.3552	301	27.3600	306
27.3479-25	294	27.3492-06	298	27.3555	301	27.3601	306
27.3479-30	294	27.3492-08	298	27.3556	301	27.3602	306
27.3480-06	295	27.3492-09	298	27.3557	301	27.3603-01	306
27.3480-08	295	27.3493-06	298	27.3558	302	27.3603-02	306
27.3480-10	295	27.3493-13	298	27.3561	302	27.3604	306
27.3480-12	295	27.3493-19	298	27.3562	302	27.3605	306
27.3480-15	295	27.3493-25	298	27.3563	302	27.3606-10	307
27.3480-20	295	27.3493-32	298	27.3571	302	27.3606-15	307
27.3480-25	295	27.3494-06	298	27.3572	302	27.3606-20	307
27.3480-30	295	27.3494-13	298	27.3573	302	27.3606-25	307
27.3481-06	295	27.3494-19	298	27.3581-01	303	27.3607-06	307
27.3481-08	295	27.3494-25	298	27.3581-02	303	27.3607-08	307
27.3481-10	295	27.3494-32	298	27.3581-03	303	27.3608	307
27.3481-12	295	27.3495-03	299	27.3581-04	303	27.3609	307
27.3481-15	295	27.3495-05	299	27.3581-05	303	27.3610	307
27.3481-20	295	27.3495-06	299	27.3581-06	303	27.3611-08	307
27.3481-25	295	27.3495-08	299	27.3582-20	303	27.3611-17	307
27.3481-30	295	27.3495-09	299	27.3582-10	303	27.3612	308
27.3482-06	295	27.3496-06	299	27.3582-01	303	27.3613	308
27.3482-09	295	27.3496-13	299	27.3582-02	303	27.3614-06	308
27.3482-13	295	27.3496-19	299	27.3583-30	303	27.3614-12	308
27.3482-16	295	27.3496-25	299	27.3583-20	303	27.3614-19	308
27.3482-19	295	27.3496-32	299	27.3583-10	303	27.3614-25	308
27.3482-25	295	27.3497-06	299	27.3583-01	303	27.3615	308
27.3482-32	295	27.3497-13	299	27.3584-30	303	27.3617	308
27.3483-06	295	27.3497-19	299	27.3584-20	303	27.3616	308
27.3483-09	295	27.3497-25	299	27.3584-10	303	27.3618	308
27.3483-13	295	27.3497-32	299	27.3584-01	303	27.3619-01	309
27.3483-16	295	27.3500	300	27.3585-00	304	27.3619-02	309
27.3483-19	295	27.3501	300	27.3585-01	304	27.3619-03	309
27.3483-25	295	27.3502	300	27.3585-02	304	27.3619-04	309
27.3483-32	295	27.3503	300	27.3585-03	304	27.3619-05	309
27.3484-06	296	27.3504	300	27.3585-04	304	27.3620	309
27.3484-09	296	27.3505	300	27.3591-01	304	27.3621	309
27.3484-13	296	27.3506	300	27.3591-02	304	27.3622-01	310
27.3484-16	296	27.3507	300	27.3591-03	304	27.3622-02	310
27.3484-19	296	27.3508	300	27.3594-01	304	27.3622-03	310
27.3484-25	296	27.3509	300	27.3594-02	304	27.3623	310
27.3484-32	296	27.3510	300	27.3594-03	304	27.3624	310
27.3485-06	296	27.3511	300	27.3594-04	304	27.3625	310
27.3485-09	296	27.3512	300	27.3594-05	304	27.3626	311
27.3485-13	296	27.3513	300	27.3595-30	305	27.3627	311
27.3485-16	296	27.3514	300	27.3595-20	305	27.3628	311
27.3485-19	296	27.3515	300	27.3595-10	305	27.3629-01	311
27.3485-25	296	27.3516	300	27.3595-01	305	27.3629-02	311
27.3485-32	296	27.3520	300	27.3595-02	305	27.3629-03	311
27.3486-05	296	27.3521	300	27.3595-03	305	27.3629-04	311
27.3486-10	296	27.3522	300	27.3595-04	305	27.3630	312

Cat. Nr. Cat.-No Kat.-Nr. No. ref.	Biz. Page Seite Pagina	Cat. Nr. Cat.-No Kat.-Nr. No. ref.	Biz. Page Seite Pagina	Cat. Nr. Cat.-No Kat.-Nr. No. ref.	Biz. Page Seite Pagina	Cat.-No Kat.-Nr. No. ref.	Page Seite Pagina
27.3631	312	27.3686-01	323	27.3755	334	27.3856-12	345
27.3632	312	27.3686-02	323	27.3754-23	334	27.3856-18	345
27.3633	312	27.3687-02	323	27.3755-23	334	27.3856-20	345
27.3634-20	312	27.3687-25	323	27.3756	335	27.3856-22	345
27.3635	312	27.3688-30	323	27.3757	335	27.3857-13	345
27.3636	312	27.3689-27	323	27.3756-27	335	27.3857-18	345
27.3640-01	313	27.3690-30	324	27.3757-27	335	27.3858	345
27.3640-02	313	27.3690-45	324	27.3758-04	335	28.3859	347
27.3640-03	313	27.3691-40	324	27.3758-08	335	28.3860-19	347
27.3640-04	313	27.3692-35	324	27.3758-23	335	28.3860-23	347
27.3640-05	313	27.3692-42	324	27.3759	336	28.3861	347
27.3642	313	27.3692-50	324	27.3760	336	28.3863	348
27.3644-15	313	27.3693-42	325	27.3761	336	28.3864	348
27.3644-19	313	27.3694-01	325	27.3761-02	336	28.3865	348
27.3644-24	313	27.3694-02	325	27.3761-03	336	28.3866	348
27.3645	313	27.3695	325	27.3762	336	28.3867	349
27.3647-01	314	27.3696-18	325	27.3763	336	28.3868	349
27.3647-02	314	27.3700-01	326	27.3763-01	337	28.3869	349
27.3647-03	314	27.3700-02	326	27.3763-02	337	28.3871	349
27.3648-01	314	27.3701-14	326	27.3764	337	28.3880	350
27.3648-02	314	27.3702	326	27.3765	337	28.3881	350
27.3648-03	314	27.3703	326	27.3766	337	28.3882-01	350
27.3650	314	27.3704-17	326	27.3767	337	28.3882-02	350
27.3651	314	27.3705-01	327	27.3768	337	28.3882-03	350
27.3652	315	27.3705-02	327	27.3769	337	28.3884	351
27.3653	315	27.3706-16	327	27.3770	338	28.3885-01	351
27.3654	315	27.3706-24	327	27.3771	338	28.3885-02	351
27.3655-01	316	27.3707	327	27.3772	338	28.3885-03	351
27.3655-02	316	27.3708	327	27.3773-01	338	28.3887-01	352
27.3655-03	316	27.3709	328	27.3773-02	338	28.3887-02	352
27.3656-01	316	27.3710	328	27.3774	339	28.3887-03	352
27.3656-02	316	27.3711	328	27.3775	339	28.3887-04	352
27.3657-18	316	27.3712	328	27.3776	339	28.3890-01	353
27.3658-01	316	27.3713	328	27.3777	339	28.3890-02	353
27.3658-02	316	27.3714	328	27.3778	339	28.3890-03	353
27.3659-01	316	27.3715	328	27.3779	339	28.3892	353
27.3659-02	316	27.3716-20	329	27.3780	339	28.3900	354
27.3660-03	317	27.3717-01	329	27.3781	340	28.3901	354
27.3661-05	317	27.3717-02	329	27.3782	340	28.3902	354
27.3662-07	317	27.3718	329	27.3783	340	28.3903	354
27.3664-06	317	27.3719	329	27.3784	340	28.3904	355
27.3664-08	317	27.3718-17	330	27.3785	340	28.3905	355
27.3665-15	317	27.3719-17	330	27.3786	340	28.3906	355
27.3666-15	318	27.3720	330	27.3787	340	28.3907-01	356
27.3667-08	318	27.3721	330	27.3788	340	28.3907-02	356
27.3667-10	318	27.3722	330	27.3789	340	28.3908-01	357
27.3666-17	318	27.3723	330	27.3790	341	28.3908-02	357
27.3666-18	318	27.3724	330	27.3791	341	28.3908-03	357
27.3667-42	318	27.3725	330	27.3792	341	28.3909	358
27.3667-65	319	27.3727	331	27.3793	341	28.3910	359
27.3668-43	319	27.3728	331	27.3814	342	28.3911	359
27.3669-22	319	27.3729	331	27.3817	342	28.3912	359
27.3669-24	319	27.3730	331	27.3819	342	28.3920-27	359
27.3669-34	319	27.3731	331	27.3822	342	28.3920-32	359
27.3670-22	320	27.3732	331	27.3824	342	28.4052	360
27.3671-30	320	27.3733	331	27.3827	342	28.4053	360
27.3671-33	320	27.3734	331	27.3829	342	28.4054	360
27.3673-21	320	27.3735	331	27.3832	342	28.4057	360
27.3674-34	320	27.3736	332	27.3838	342	28.4058	360
27.3675-45	320	27.3737	332	27.3839	342	28.4059	360
27.3675-65	320	27.3738	332	27.3840	342	28.4060	361
27.3676-01	321	27.3739	332	27.3841	342	28.4061-01	361
27.3676-02	321	27.3740	333	27.3842	342	28.4061-02	361
27.3677-18	321	27.3741	333	27.3843	342	28.4064	361
27.3678-07	321	27.3742	333	27.3844	343	28.4065	361
27.3678-10	321	27.3743	333	27.3845	343	28.4066	361
27.3679-01	321	27.3744	333	27.3846	343	28.4067	361
27.3679-02	321	27.3745	333	27.3847	343	28.4068	362
27.3680-28	322	27.3746	333	27.3848	343	28.4071	362
27.3681-25	322	27.3747	333	27.3849	343	28.4072	362
27.3681-30	322	27.3748	333	27.3850	344	28.4073	362
27.3681-35	322	27.3750-01	334	27.3851	344	28.4080-05	362
27.3682-30	322	27.3750-02	334	27.3852	344	28.4080-10	362
27.3683-25	322	27.3750-03	334	27.3853	344	28.4080-15	362
27.3684-01	322	27.3751-19	334	27.3854	344	28.4080-20	362
27.3684-02	322	27.3752-19	334	27.3855-12	345	28.4080-25	362
27.3685-02	323	27.3753	334	27.3855-18	345	28.4080-30	362
27.3685-17	323	27.3754	334	27.3855-20	345	28.4080-35	362

Cat. Nr. Cat.-No Kat.-Nr. No. ref.	Biz. Page Seite Pagina	Cat. Nr. Cat.-No Kat.-Nr. No. ref.	Biz. Page Seite Pagina	Cat. Nr. Cat.-No Kat.-Nr. No. ref.	Biz. Page Seite Pagina	Cat.-No Kat.-Nr. No. ref.	Page Seite Pagina
28.4080-40	362	30.4253-01	375	31.4431-13	384	32.4602-13	393
28.4080-45	362	30.4253-02	375	31.4431-16	384	32.4602-14	393
28.4080-50	362	30.4253-03	375	31.4431-18	384	32.4602-15	393
28.4080-70	362	30.4253-04	375	31.4431-21	384	32.4602-16	393
28.4080-90	362	30.4263-00	376	31.4431-23	384	32.4602-18	393
29.4100	364	30.4263-01	376	31.4432-25	385	32.4602-20	393
29.4101	364	30.4263-02	376	31.4433-25	385	32.4602-22	393
29.4110-01	364	30.4263-03	376	31.4434-22	386	32.4602-24	393
29.4110-02	364	30.4263-04	376	31.4434-25	386	32.4610-24	394
29.4112-01	364	30.4267	377	31.4434-28	386	32.4610-25	394
29.4112-02	364	30.4266-02	377	31.4435-22	386	32.4610-26	394
29.4113	365	30.4268	377	31.4435-25	386	32.4610-27	394
29.4114	365	30.4270-01	377	31.4435-28	386	32.4610-28	394
29.4115	365	30.4270-02	377	32.4450	388	32.4610-29	394
29.4116	365	31.4300	379	32.4451	388	32.4610-30	394
29.4117	365	31.4301-13	379	32.4452	388	32.4610-31	394
29.4118	365	31.4301-14	379	32.4453	388	32.4610-32	394
29.4119	365	31.4302	379	32.4454	388	32.4610-33	394
29.4120-07	366	31.4303	379	32.4455	388	32.4610-34	394
29.4120-09	366	31.4304	379	32.4460	389	32.4610-35	394
29.4130-01	366	31.4305	379	32.4461	389	32.4610-36	394
29.4130-02	366	31.4306	379	32.4462	389	32.4610-37	394
29.4131-01	366	31.4307	379	32.4463	389	32.4610-38	394
29.4131-02	366	31.4309	379	32.4464	389	32.4610-39	394
29.4132-01	366	31.4310	379	32.4465	389	32.4610-40	394
29.4132-02	366	31.4313	379	32.4466	389	32.4610-41	394
29.4133-01	366	31.4311	380	32.4470	390	32.4610-42	394
29.4133-02	366	31.4312	380	32.4471	390	32.4610-43	394
29.4134-01	366	31.4315-15	380	32.4472	390	32.4610-44	394
29.4134-02	366	31.4315-20	380	32.4473	390	32.4610-45	394
29.4135-01	366	31.4315-22	380	32.4481	390	32.4610-46	394
29.4135-02	366	31.4315-25	380	32.4482	390	32.4610-47	394
29.4136-01	366	31.4319	380	32.4483	390	32.4610-48	394
29.4136-02	366	31.4320	380	32.4484	390	32.4610-49	394
29.4137-01	366	31.4321	380	32.4485	390	32.4610-50	394
29.4137-02	366	31.4322	380	32.4486	390	32.4610-51	394
29.4138-01	366	31.4323	380	32.4487	390	32.4610-52	394
29.4138-02	366	31.4324-16	380	32.4488	390	32.4610-53	394
29.4139-01	366	31.4324-21	380	32.4489	390	32.4610-54	394
29.4139-02	366	31.4330	380	32.4490	390	32.4610-55	394
29.4150-15	366	31.4332	381	32.4491	390	32.4610-56	394
29.4150-20	366	31.4399	381	32.4492	390	32.4610-57	394
30.4200	368	31.4400	381	32.4493	390	32.4610-58	394
30.4202	368	31.4401	381	32.4501	391	32.4610-59	394
30.4203-01	368	31.4402	381	32.4502	391	32.4610-60	394
30.4203-02	368	31.4403	381	32.4503	391	32.4611-24	394
30.4203-03	368	31.4404	381	32.4504	391	32.4611-25	394
30.4203-04	368	31.4405	381	32.4501-01	391	32.4611-26	394
30.4205-03	368	31.4406	381	32.4501-02	391	32.4611-27	394
30.4205-04	368	31.4407	381	32.4501-03	391	32.4611-28	394
30.4225-01	368	31.4408	381	32.4501-04	391	32.4611-29	394
30.4203-00	369	31.4409	381	32.4501-05	391	32.4611-30	394
30.4227-01	369	31.4410	381	32.4501-06	391	32.4611-31	394
30.4227-02	369	31.4411-22	382	32.4501-07	391	32.4611-32	394
30.4210	370	31.4411-25	382	32.4501-08	391	32.4611-33	394
30.4212-00	370	31.4411-28	382	32.4511	392	32.4611-34	394
30.4212-01	370	31.4412-22	382	32.4512	392	32.4611-35	394
30.4212-02	370	31.4412-25	382	32.4513	392	32.4611-36	394
30.4212-03	370	31.4412-28	382	32.4514	392	32.4611-37	394
30.4212-04	370	31.4415-05	382	32.4520	392	32.4611-38	394
30.4213	370	31.4415-07	382	32.4525	392	32.4611-39	394
30.4221-00	371	31.4415-10	382	32.4600-06	393	32.4611-40	394
30.4221-01	371	31.4416-08	383	32.4600-08	393	32.4611-41	394
30.4221-02	371	31.4416-23	383	32.4600-10	393	32.4611-42	394
30.4221-03	371	31.4417-26	383	32.4600-12	393	32.4611-43	394
30.4221-04	371	31.4420	383	32.4600-14	393	32.4611-44	394
30.4225-02	372	31.4421	383	32.4600-16	393	32.4611-45	394
30.4225-03	372	31.4422	383	32.4600-18	393	32.4611-46	394
30.4226	372	31.4423	383	32.4600-20	393	32.4611-47	394
30.4240	373	31.4424	383	32.4600-22	393	32.4611-48	394
30.4243-00	373	31.4425	383	32.4600-24	393	32.4611-49	394
30.4243-01	373	31.4426	383	32.4602-06	393	32.4611-50	394
30.4243-02	373	31.4427	383	32.4602-07	393	32.4611-51	394
30.4243-03	373	31.4430-13	384	32.4602-08	393	32.4611-52	394
30.4243-04	373	31.4430-16	384	32.4602-09	393	32.4611-53	394
30.4266-01	373	31.4430-18	384	32.4602-10	393	32.4611-54	394
30.4250	374	31.4430-21	384	32.4602-11	393	32.4611-55	394
30.4253-00	375	31.4430-23	384	32.4602-12	393	32.4611-56	394

Cat. Nr. Cat.-No Kat.-Nr. No. ref.	Biz. Page Seite Pagina	Cat. Nr. Cat.-No Kat.-Nr. No. ref.	Biz. Page Seite Pagina	Cat. Nr. Cat.-No Kat.-Nr. No. ref.	Biz. Page Seite Pagina	Cat.-No Kat.-Nr. No. ref.	Page Seite Pagina
32.4611-57	394	33.4710-01	403	33.4870	411	33.4755	415
32.4611-58	394	33.4709-11	403	33.4871	411	33.4756	415
32.4611-59	394	33.4710-11	403	33.4873-00	411	33.4757	415
32.4611-60	394	33.4721	403	33.4873-01	411	33.4758	415
32.4613-06	395	33.4722	403	33.4873-02	411	33.4759	415
32.4613-07	395	33.4723	403	33.4873-03	411	33.4760	415
32.4613-08	395	33.4721-01	403	33.4873-04	411	33.4761	415
32.4613-09	395	33.4722-02	403	33.4873-05	411	33.4762	415
32.4613-10	395	33.4723-03	403	33.4873-10	411	33.4763	415
32.4613-11	395	33.4721-11	403	33.4873-40	411	33.4764	415
32.4613-12	395	33.4722-12	403	33.4873-80	411	33.4765	415
32.4613-13	395	33.4723-13	403	33.4875	412	33.4766	415
32.4613-14	395	33.4800	404	33.4875L	412	33.4767	415
32.4613-15	395	33.4801	404	33.4876	412	33.4768	415
32.4613-16	395	33.4802	404	33.4876L	412	33.4769	415
32.4613-17	395	33.4803	404	33.4877	412	33.4770	415
32.4613-18	395	33.4805	404	33.4877L	412	33.4771	415
32.4613-19	395	33.4806	404	33.4878	413	33.4772	415
32.4613-20	395	33.4807	404	33.4879	413	33.4773	415
32.4613-21	395	33.4811	404	33.4880	414	33.4774	415
32.4613-22	395	33.4812	404	33.4880L	414	33.4775	415
32.4613-23	395	33.4813	404	33.4881	414	33.4776	415
32.4613-24	395	33.4816-01	405	33.4881L	414	33.4777	415
32.4613-25	395	33.4816-02	405	33.4884	414	33.4778	415
32.4613-26	395	33.4821	405	33.4884L	414	33.4779	415
32.4613-27	395	33.4822	405	33.4885	414	33.4780	415
32.4613-28	395	33.4823	405	33.4885L	414	33.4781	415
32.4613-29	395	33.4824	405	33.4886	414	33.4782	415
32.4613-30	395	33.4825	405	33.4886L	414	33.4901	415
32.4613-31	395	33.4826	405	33.4887	414	33.4902	415
32.4613-32	395	33.4811L	406	33.4887L	414	33.4903	416
32.4613-33	395	33.4812L	406	33.4729-03	415	33.4904	416
32.4613-34	395	33.4813L	406	33.4729-04	415	33.4905	416
32.4613-35	395	33.4824L	406	33.4729-05	415	33.4904-10	416
32.4613-36	395	33.4825L	406	33.4729-06	415	33.4905-10	416
32.4620	396	33.4826L	406	33.4729-07	415	33.4784	417
32.4621	396	33.4827	407	33.4729-08	415	33.4785	417
32.4622	396	33.4828	407	33.4729-09	415	33.4786	417
32.4625	397	33.4829	407	33.4729-10	415	33.4787	417
32.4626-00	397	33.4831	407	33.4729-11	415	33.4788	417
32.4626-10	397	33.4832	407	33.4729-12	415	33.4789	417
32.4626-57	397	33.4833	407	33.4729-13	415	33.4790	417
32.4626-80	397	33.4834-01	407	33.4729-14	415	33.4791	417
32.4626-99	397	33.4834-02	407	33.4729-15	415	33.4792	417
32.4627	397	33.4835-01	407	33.4729-16	415	33.4793	417
32.4648-08	398	33.4835-02	407	33.4729-17	415	33.4794	417
32.4648-11	398	33.4836-01	407	33.4729-18	415	33.4795	417
32.4648-13	398	33.4836-02	407	33.4729-19	415	33.4796	417
32.4648-16	398	33.4837-20	408	33.4729-20	415	33.4908	417
32.4648-21	398	33.4837-25	408	33.4729-21	415	33.4909	417
32.4648-26	398	33.4837-30	408	33.4729-22	415	33.4910	417
32.4648-32	398	33.4837-35	408	33.4729-23	415	33.4911	417
32.4650-20	398	33.4837-40	408	33.4729-24	415	33.4912	417
32.4650-28	398	33.4838-20	408	33.4730	415	33.4908-10	417
32.4656	398	33.4838-25	408	33.4731	415	33.4909-10	417
32.4657	398	33.4838-30	408	33.4732	415	33.4913-00	418
32.4660	399	33.4838-35	408	33.4733	415	33.4913-09	418
32.4661	399	33.4838-40	408	33.4734	415	33.4913-11	418
32.4662	399	33.4839	408	33.4735	415	33.4913-13	418
32.4663	399	33.4840	408	33.4736	415	33.4913-15	418
32.4670	400	33.4840-01	409	33.4737	415	33.4913-17	418
32.4671	400	33.4840-02	409	33.4738	415	33.4913-19	418
32.4672-01	400	33.4841	409	33.4739	415	33.4920	418
32.4672-02	400	33.4842	409	33.4740	415	33.4921	418
32.4672-03	400	33.4843	409	33.4741	415	33.4923	418
33.4700	402	33.4844	409	33.4742	415	33.4924	418
33.4701	402	33.4851	409	33.4743	415	33.4949	419
33.4702	402	33.4852	409	33.4744	415	33.4950	419
33.4703	402	33.4853	409	33.4745	415	33.4950L	419
33.4701-01	402	33.4854	409	33.4746	415	33.4951	419
33.4702-02	402	33.4861	409	33.4747	415	33.4952	419
33.4703-03	402	33.4862	409	33.4748	415	33.4952L	419
33.4701-11	402	33.4863	409	33.4749	415	33.4953	419
33.4702-12	402	33.4864	409	33.4750	415	33.4954	420
33.4703-13	402	33.4865	410	33.4751	415	33.4959	420
33.4709	403	33.4865L	410	33.4752	415	33.4960	420
33.4710	403	33.4866	410	33.4753	415	33.4961	420
33.4709-01	403	33.4866L	410	33.4754	415	33.4962	421

Cat. Nr. Cat.-No Kat.-Nr. No. ref.	Biz. Page Seite Pagina	Cat. Nr. Cat.-No Kat.-Nr. No. ref.	Biz. Page Seite Pagina	Cat. Nr. Cat.-No Kat.-Nr. No. ref.	Biz. Page Seite Pagina	Cat.-No Kat.-Nr. No. ref.	Page Seite Pagina
33.4965	421	33.5073	435	33.5140-13	436	34.5407	445
33.4966	421	33.5074	435	33.5140-14	436	34.5408	445
33.4967	421	33.5075	435	33.5140-15	436	34.5409	445
33.4970	421	33.5076	435	33.5140-16	436	34.5410	445
33.4971	421	33.5081	435	33.5150-20	436	34.5411	445
33.4972	421	33.5082	435	33.5150-00	436	34.5412	445
33.4973	421	33.5083	435	33.5150-01	436	34.5413	445
33.4974	421	33.5084	435	33.5150-02	436	34.5414	445
33.4975	421	33.5085	435	33.5150-03	436	34.5415	445
33.4989	422	33.5086	435	33.5150-04	436	34.5416	446
33.4990	422	33.5091	435	33.5150-05	436	34.5417	446
33.4995	422	33.5092	435	33.5150-06	436	34.5418	446
33.5000	423	33.5093	435	33.5150-07	436	34.5419	446
33.5001	423	33.5094	435	33.5150-08	436	34.5421	445
33.5002	423	33.5095	435	33.5150-09	436	34.5422	445
33.5010-01	423	33.5096	435	33.5150-10	436	34.5423	445
33.5010-02	423	33.5101	435	33.5150-11	436	34.5424	445
33.5015	424	33.5102	435	33.5150-12	436	34.5425	445
33.5018	424	33.5103	435	33.5150-13	436	34.5426	445
33.5020	425	33.5104	435	33.5150-14	436	34.5427	445
33.5021	425	33.5105	435	33.5150-15	436	34.5428	445
33.5022	425	33.5106	435	33.5150-16	436	34.5429	445
33.5023	425	33.5111	435	33.5160	437	34.5430	445
33.5024	425	33.5112	435	33.5161	437	34.5431	445
33.5025	425	33.5113	435	33.5162	437	34.5432	445
33.5026	426	33.5114	435	33.5163	437	34.5433	445
33.5027	426	33.5115	435	33.5164	437	34.5434	445
33.5028-01	427	33.5116	435	33.5165	437	34.5435	445
33.5028-02	427	33.5120-20	436	33.5166	437	34.5436	446
33.5028-03	427	33.5120-00	436	33.5170	437	34.5437	446
33.5029-01	427	33.5120-01	436	33.5171	437	34.5438	446
33.5029-02	427	33.5120-02	436	33.5172	437	34.5439	446
33.5029-03	427	33.5120-03	436	33.5173	437	34.5440	447
33.5031	427	33.5120-04	436	33.5174	437	34.5441	447
33.5032	427	33.5120-05	436	33.5175	437	34.5442	447
33.5033	427	33.5120-06	436	33.5176	437	34.5445	448
33.5032-38	427	33.5120-07	436	33.5180	438	34.5446	448
33.5035-01	428	33.5120-08	436	33.5181	438	34.5447	448
33.5035-02	428	33.5120-09	436	33.5190-01	439	34.5450-10	449
33.5035-03	428	33.5120-10	436	33.5190-02	439	34.5450-15	449
33.5036-01	428	33.5120-11	436	33.5190-03	439	34.5452-13	449
33.5036-02	428	33.5120-12	436	33.5190-04	439	34.5452-17	449
33.5036-03	428	33.5120-13	436	33.5190-05	439	34.5453-13	449
33.5037	428	33.5120-14	436	33.5190-06	439	34.5453-17	449
33.5038	428	33.5120-15	436	33.5191-01	439	34.5454-13	449
33.5039	428	33.5120-16	436	33.5191-02	439	34.5454-17	449
33.5039-38	428	33.5130-20	436	33.5191-03	439	34.5455-13	449
33.5040	429	33.5130-00	436	33.5191-04	439	34.5455-17	449
33.5041	429	33.5130-01	436	33.5191-05	439	34.5456-13	449
33.5042	429	33.5130-02	436	33.5191-06	439	34.5456-17	449
33.5043	429	33.5130-03	436	33.5301	440	34.5457-13	449
33.5044	429	33.5130-04	436	33.5302	440	34.5457-17	449
33.5049	429	33.5130-05	436	33.5310	440	34.5460	450
33.5047	430	33.5130-06	436	33.5311	440	34.5461	450
33.5048	430	33.5130-07	436	33.5318	440	34.5462	450
33.5051	430	33.5130-08	436	33.5320	440	34.5470	451
33.5052	430	33.5130-09	436	33.5321	440	34.5471	451
33.5053	430	33.5130-10	436	33.5323	440	34.5472-01	452
33.5054	431	33.5130-11	436	33.5325	441	34.5472-02	452
33.5055	431	33.5130-12	436	33.5327	441	34.5473	452
33.5056	432	33.5130-13	436	33.5330	441	34.5501	453
33.5057	432	33.5130-14	436	33.5333	441	34.5502	453
33.5058	432	33.5130-15	436	33.5338	441	34.5503	453
33.5059	432	33.5130-16	436	33.5380	442	34.5506	453
33.5060-01	433	33.5140-20	436	33.5381	442	34.5507	453
33.5060-02	433	33.5140-00	436	33.5382	442	34.5508	453
33.5060-03	433	33.5140-01	436	33.5385	442	34.5510	453
33.5060-04	433	33.5140-02	436	33.5386	442	34.5511	453
33.5061	433	33.5140-03	436	33.5387	442	34.5513-35	454
33.5062	433	33.5140-04	436	33.5390	442	34.5513-50	454
33.5063	433	33.5140-05	436	33.5391	442	34.5513-75	454
33.5064	434	33.5140-06	436	33.5395	443	34.5513-90	454
33.5065	434	33.5140-07	436	34.5401	445	34.5514-45	454
33.5066	434	33.5140-08	436	34.5402	445	34.5514-75	454
33.5067	434	33.5140-09	436	34.5403	445	34.5515	455
33.5068	434	33.5140-10	436	34.5404	445	34.5516	455
33.5071	435	33.5140-11	436	34.5405	445	34.5517	455
33.5072	435	33.5140-12	436	34.5406	445	34.5518	455

Cat. Nr. Cat.-No Kat.-Nr. No. ref.	Biz. Page Seite Pagina	Cat. Nr. Cat.-No Kat.-Nr. No. ref.	Biz. Page Seite Pagina	Cat. Nr. Cat.-No Kat.-Nr. No. ref.	Biz. Page Seite Pagina	Cat.-No Kat.-Nr. No. ref.	Page Seite Pagina
34.5522-01	455	34.5628-03	465	34.5722	473	34.6022-02	484
34.5522-02	455	34.5628-04	465	34.5723	473	34.6025	485
34.5522-03	455	34.5629-03	465	34.5724	473	34.6026	485
34.5522-04	455	34.5629-04	465	34.5731	474	34.6027	485
34.5522-05	455	34.5629-07	465	34.5732	474	34.6205-30	486
34.5522-06	455	34.5629-09	465	34.5733	474	34.6205-20	486
34.5522-07	455	34.5630-10	465	34.5735	474	34.6205-00	486
34.5530	456	34.5630-12	465	34.5736	474	34.6205-01	486
34.5531	456	34.5630-14	465	34.5737	474	34.6205-02	486
34.5532-30	456	34.5631-01	466	34.5803	475	34.6205-03	486
34.5532-40	456	34.5631-02	466	34.5807	475	34.6205-04	486
34.6018	456	34.5631-03	466	34.5810	475	34.6206-30	486
34.5549	457	34.5632-01	466	34.5814	475	34.6206-20	486
34.5550	457	34.5632-02	466	34.5815	475	34.6206-00	486
34.5551	457	34.5633	466	34.5821	475	34.6206-01	486
34.5552	457	34.5634-01	466	34.5823	475	34.6206-02	486
34.5553	457	34.5634-02	466	34.5825	475	34.6206-03	486
34.5554	458	34.5635-01	467	34.5830	475	34.6206-04	486
34.5555	458	34.5635-02	467	34.5831	475	34.6207-30	486
34.5556	458	34.5635-03	467	34.5833	475	34.6207-20	486
34.5557	458	34.5636-01	467	34.5835	475	34.6207-00	486
34.5559	458	34.5636-02	467	34.5839	476	34.6207-01	486
34.5560	458	34.5641-18	468	34.5840-01	476	34.6207-02	486
34.5562	458	34.5641-21	468	34.5840-02	476	34.6207-03	486
34.5563	458	34.5642-21	468	34.5840-03	476	34.6207-04	486
34.5565	458	34.5643-01	468	34.5841	476	34.6208-30	486
34.5566	458	34.5643-02	468	34.5842	476	34.6208-20	486
34.5567	458	34.5644-01	468	34.5843	476	34.6208-00	486
34.5568	459	34.5644-02	468	34.5844	476	34.6208-01	486
34.5569	459	34.5650-01	469	34.5845	476	34.6208-02	486
34.5570	459	34.5650-02	469	34.5846	476	34.6208-03	486
34.5571-18	459	34.5650-03	469	34.5849	477	34.6208-04	486
34.5573-01	459	34.5651-15	469	34.5850	477	34.6210-01	487
34.5573-02	459	34.5652-16	469	34.5851	477	34.6210-02	487
34.5574-01	460	34.5654-22	469	34.5852	477	34.6210-03	487
34.5574-02	460	34.5655-17	469	34.5853	477	34.6210-04	487
34.5590	461	34.5656-19	469	34.5859	478	34.6211	487
34.5591	461	34.5658-14	469	34.5861	478	34.6213	487
34.5592	461	34.5659-10	469	34.5862	478	34.6214	487
34.5593	461	34.5660-12	469	34.5863	478	34.6218-01	487
34.5596	461	34.5661-15	470	34.5869	479	34.6218-02	487
34.5597	461	34.5663-02	470	34.5870	479	34.6218-03	487
34.5598	461	34.5663-05	470	34.5871	479	34.6220-01	488
34.5601	462	34.5663-07	470	34.5872	479	34.6220-02	488
34.5602	462	34.5663-10	470	34.5873	479	34.6220-03	488
34.5603	462	34.5664-16	470	34.5874	479	34.6222-01	488
34.5604	462	34.5665-20	470	34.5875	479	34.6222-02	488
34.5605	462	34.5667-01	470	34.5883	480	34.6222-03	488
34.5606	462	34.5667-02	470	34.5884	480	34.6222-04	488
34.5607	462	34.5667-03	470	34.5888	480	34.6222-05	488
34.5608	462	34.5668-14	471	34.5890	480	34.6222-06	488
34.5609-18	463	34.5669-16	471	34.5891	480	34.6222-07	488
34.5609-22	463	34.5670-15	471	34.5892	480	34.6250-01	488
34.5610	463	34.5671-15	471	34.5893	480	34.6250-02	488
34.5611	463	34.5680-03	471	34.5894	480	34.6250-03	488
34.5613	463	34.5680-04	471	34.5895	480	34.6250-04	488
34.5614	463	34.5680-05	471	34.5896	480	34.6250-05	488
34.5617	463	34.5681-03	471	34.5900	481	34.6290-01	489
34.5620-04	464	34.5681-04	471	34.5901	481	34.6290-02	489
34.5620-07	464	34.5681-05	471	34.5907	481	34.6291-01	489
34.5620-09	464	34.5685-01	472	34.5907-02	481	34.6291-02	489
34.5620-12	464	34.5685-02	472	34.6001	482	34.6298-01	489
34.5621-06	464	34.5686-16	472	34.6002	482	34.6298-02	489
34.5622-04	464	34.5687-15	472	34.6003	482	34.6298-03	489
34.5622-07	464	34.5688-15	472	34.6004	482	34.6400	490
34.5622-09	464	34.5689-16	472	34.6005	482	34.6401-08	490
34.5622-12	464	34.5690-15	472	34.6006	482	34.6401-14	490
34.5623-06	464	34.5700	473	34.6010	483	34.6401-16	490
34.5624-16	464	34.5701	473	34.6011	483	34.6406	490
34.5625-16	464	34.5702	473	34.6012	483	34.6407	490
34.5626-04	465	34.5703	473	34.6013	483	34.6408	490
34.5626-05	465	34.5704	473	34.6019	483	34.6409-20	490
34.5626-06	465	34.5705	473	34.6010-40	483	34.6409-22	490
34.5626-07	465	34.5711	473	34.6010-50	483	34.6409-25	490
34.5627-10	465	34.5712	473	34.6020-01	484	34.6409-30	490
34.5627-12	465	34.5713	473	34.6020-02	484	34.6410	490
34.5627-14	465	34.5714	473	34.6021	484	34.6420-01	491
34.5627-16	465	34.5721	473	34.6022-01	484	34.6421-01	491

Cat. Nr. Cat.-No Kat.-Nr. No. ref.	Biz. Page Seite Pagina	Cat. Nr. Cat.-No Kat.-Nr. No. ref.	Biz. Page Seite Pagina	Cat. Nr. Cat.-No Kat.-Nr. No. ref.	Biz. Page Seite Pagina	Cat.-No Kat.-Nr. No. ref.	Page Seite Pagina
34.6421-02	491	35.7101	500	35.7234	505	35.7347	511
34.6422	491	35.7102	500	35.7235	505	35.7348	511
34.6430-01	492	35.7103	500	35.7236	505	35.7349	511
34.6430-02	492	35.7110	500	35.7237	505	35.7350	511
34.6430-03	492	35.7112	500	35.7238	505	35.7351	511
34.6430-04	492	35.7113	500	35.7239	505	35.7360	512
34.6430-05	492	35.7114	500	35.7240	505	35.7361	512
34.6430-06	492	35.7115	500	35.7241	505	35.7362	512
34.6431-01	492	35.7116	500	35.7242	505	35.7363	512
34.6431-02	492	35.7120	501	35.7243	505	35.7364	512
34.6466	493	35.7121	501	35.7244	505	35.7349	512
34.6467	493	35.7130	501	35.7245	505	35.7370	512
35.7000	495	35.7131	501	35.7246	505	35.7371	512
35.7001	495	35.7133	501	35.7247	505	35.7380	513
35.7002	495	35.7134	501	35.7248	505	35.7381	513
35.7003	495	35.7135	501	35.7249	505	35.7382	513
35.7004	495	35.7136	501	35.7250	505	35.7383	513
35.7005	495	35.7140	501	35.7251	505	35.7384	513
35.7006	495	35.7149	502	35.7252	505	35.7385	513
35.7007	495	35.7150	502	35.7253	505	35.7386	513
35.7008	495	35.7151	502	35.7254	506	35.7387	513
35.7009	495	35.7152	502	35.7255	506	35.7388	513
35.7010	495	35.7153	502	35.7256	506	35.7389	514
35.7012	496	35.7154	502	35.7257	506	35.7390	514
35.7013	496	35.7155	502	35.7258	506	35.7391	514
35.7014	496	35.7156	502	35.7261	506	35.7392	514
35.7015	496	35.7157	502	35.7266	506	35.7393	514
35.7016	496	35.7158	502	35.7267	506	35.7394	514
35.7017	496	35.7159	502	35.7268	506	35.7395	514
35.7018	496	35.7160	502	35.7269	506	35.7396	514
35.7019	496	35.7161	502	35.7270	507	35.7397	514
35.7020	496	35.7162	502	35.7271	507	35.7398	515
35.7021	496	35.7163	502	35.7272	507	35.7399	515
35.7022	496	35.7164	502	35.7273	507	35.7400	515
35.7023	496	35.7165	502	35.7274	507	35.7401	515
35.7024	496	35.7166	502	35.7275	507	35.7402	515
35.7025-01	496	35.7167	502	35.7276	507	35.7403	515
35.7025-02	496	35.7168	502	35.7277	507	35.7404	515
35.7026-01	496	35.7180	503	35.7278	507	35.7405	515
35.7026-02	496	35.7181	503	35.7280	507	35.7406	515
35.7027-01	496	35.7182	503	35.7281	507	35.7407	515
35.7027-02	496	35.7183	503	35.7282	508	35.7408	516
35.7029	496	35.7184	503	35.7283	508	35.7409	516
35.7050	497	35.7185	503	35.7284	508	35.7410	516
35.7051	497	35.7186	503	35.7287	508	35.7411	516
35.7052	497	35.7187	503	35.7288	508	35.7412	516
35.7053	497	35.7188	503	35.7289	508	35.7413	516
35.7054	497	35.7189	503	35.7300	509	35.7414	516
35.7055-01	497	35.7190	503	35.7301	509	35.7415	516
35.7055-02	497	35.7191	503	35.7302	509	35.7416	517
35.7056-01	497	35.7200	504	35.7303	509	35.7417	517
35.7056-02	497	35.7201	504	35.7304	509	35.7418	517
35.7058-01	497	35.7202	504	35.7305	509	35.7419	517
35.7058-02	497	35.7203	504	35.7306	509	35.7420	517
35.7060	498	35.7204	504	35.7307	509	35.7421	517
35.7061	498	35.7205	504	35.7308	509	35.7422	517
35.7062	498	35.7207-01	504	35.7310	509	35.7423	517
35.7063	498	35.7207-02	504	35.7311	509	35.7424	517
35.7064	498	35.7207-03	504	35.7312	509	35.7425	517
35.7065	498	35.7210	504	35.7313	509	35.7426	517
35.7066	498	35.7211	504	35.7314	509	35.7427	517
35.7067	498	35.7212	504	35.7330	510	35.7428	517
35.7068	498	35.7213	504	35.7331	510	35.7429	517
35.7069	498	35.7214	504	35.7332	510	35.7430	517
35.7070	498	35.7215	504	35.7333	510	35.7432-01	518
35.7071	498	35.7216	504	35.7334	510	35.7432-02	518
35.7080	499	35.7217	504	35.7335	510	35.7432-03	518
35.7084	499	35.7218	504	35.7336	510	35.7433-01	518
35.7085	499	35.7219	504	35.7337	510	35.7433-02	518
35.7086	499	35.7220	504	35.7338	510	35.7434-01	518
35.7087	499	35.7221	504	35.7339	510	35.7434-02	518
35.7088-05	499	35.7222	504	35.7340	510	35.7450	519
35.7088-09	499	35.7223	504	35.7341	510	35.7451	519
35.7088-15	499	35.7224	504	35.7342	510	35.7452	519
35.7089	499	35.7230	505	35.7343	511	35.7453	519
35.7090	499	35.7231	505	35.7344	511	35.7454	519
35.7091	499	35.7232	505	35.7345	511	35.7455	519
35.7100	500	35.7233	505	35.7346	511	35.7456	519

Cat. Nr. Cat.-No Kat.-Nr. No. ref.	Biz. Page Seite Pagina	Cat. Nr. Cat.-No Kat.-Nr. No. ref.	Biz. Page Seite Pagina	Cat. Nr. Cat.-No Kat.-Nr. No. ref.	Biz. Page Seite Pagina	Cat.-No Kat.-Nr. No. ref.	Page Seite Pagina
---	---------------------------------	---	---------------------------------	---	---------------------------------	---------------------------------	-------------------------

35.7457.....	519						
35.7458.....	519						
35.7459.....	519						
35.7460.....	519						
35.7461.....	519						
35.7470.....	519						
35.7471.....	519						
35.7472.....	519						
35.7473.....	519						
35.7474.....	519						
35.7475.....	519						
35.7476.....	519						
35.7477.....	519						
35.7478.....	519						
35.7479.....	519						
35.7480.....	519						
35.7481.....	519						
35.7483.....	520						
35.7485.....	520						
35.7490.....	520						
35.7491.....	520						
35.7492.....	520						
35.7493.....	520						
35.7494.....	520						
35.7495.....	520						
35.7496.....	520						
35.7497.....	520						
35.7500.....	521						
35.7501.....	521						
35.7502.....	521						
35.7503.....	521						
35.7504.....	521						
35.7505.....	521						

